

THIS DRAWING IS UNPUBLISHED. RELEASED FOR PUBLICATION 20  
 © COPYRIGHT 20 BY - ALL RIGHTS RESERVED.

LOC	DIST	REVISIONS					
FT	0	P	LTR	DESCRIPTION	DATE	DWN	APVD
		C2		REVISED PER ECO-11-005027	18MAR2011	RK	HMR
		C3		NEW P/N 5-1546105-4 ADDED	17OCT2017	FP	FP

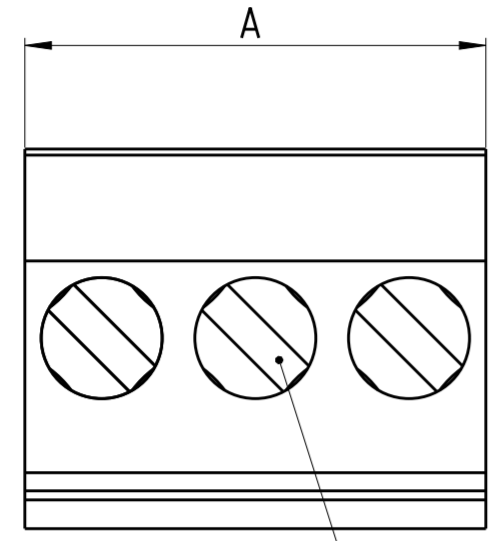

- 1 MATERIALS AND FINISH  
 HOUSING: PA 6-6, UL 94-V0, COLOR: BLACK.  
 CLAMP: BRASS, NICKEL PLATED.  
 CONTACT SPRING : PHOSPHOR BRONZE, FINISH: SEE TABLE.  
 CLAMPING SCREW: M3, BRASS, NICKEL PLATED.
- 2. WIRE SIZE RANGE: 12 - 30 AWG
- 3 NOT CUMULATIVE TOLERANCE.
- 4. INK MARKING: WHITE COLOR.

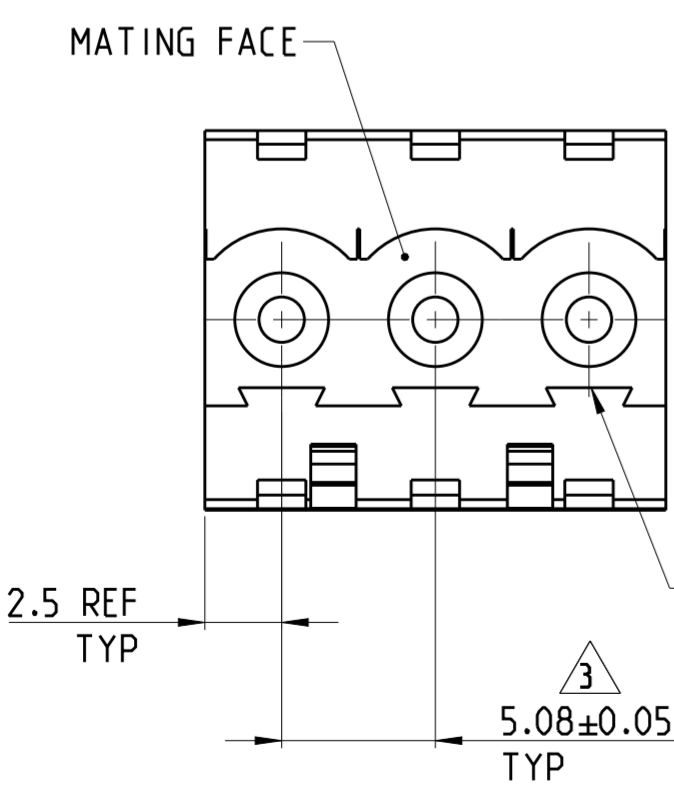
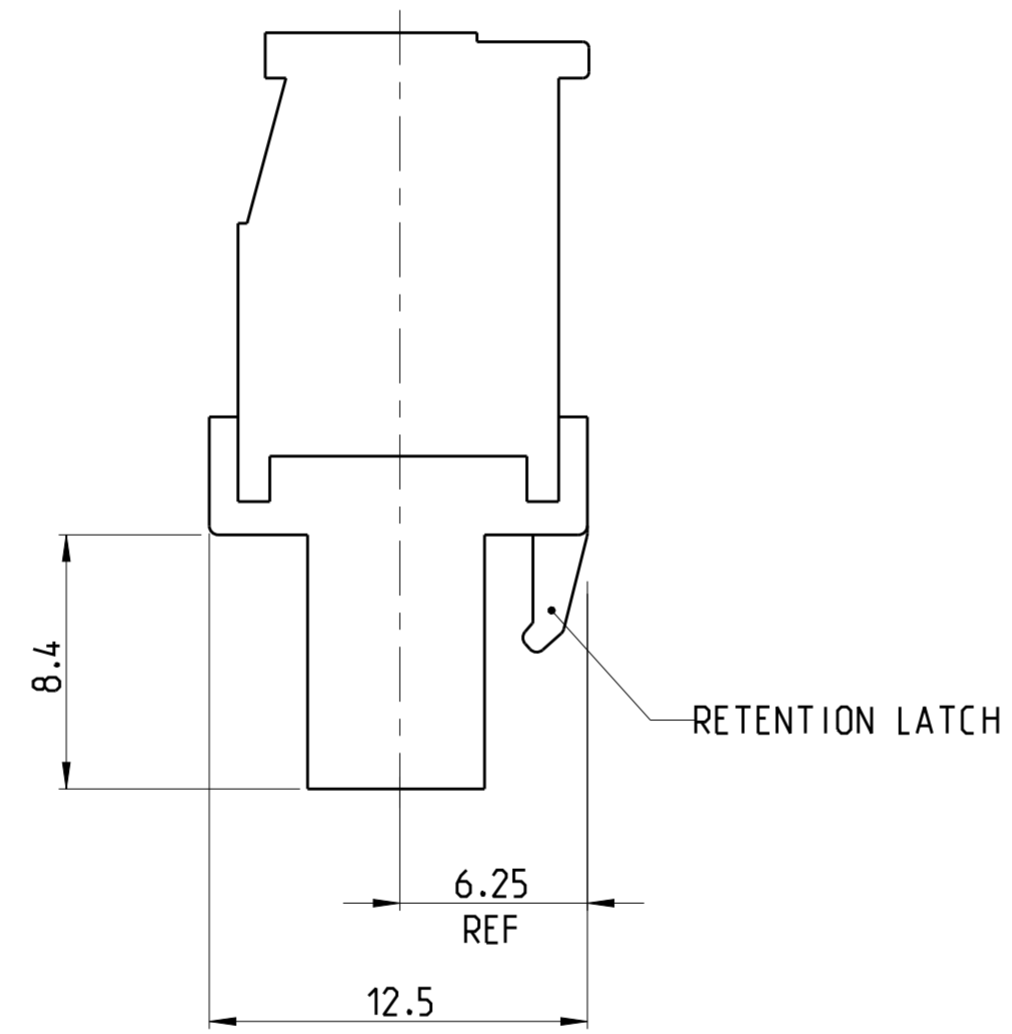
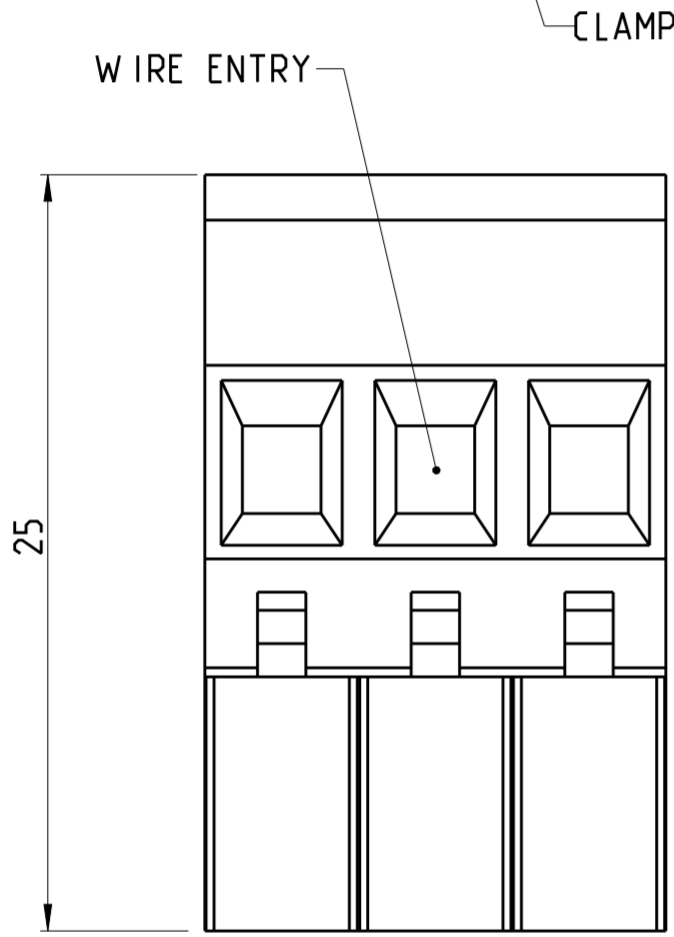

PRELIMINARY	SEE DETAIL Z	TIN	20.32	4	5-1546105-4
PRELIMINARY	SEE DETAIL X	TIN	60.96	12	6-1546105-0
PRELIMINARY	-	.762 μm GOLD	50.80	10	5-1546105-9
PRELIMINARY	-	.762 μm GOLD	40.64	8	5-1546105-8
PRELIMINARY	-	.762 μm GOLD	35.56	7	5-1546105-7
	SEE DETAIL W	TIN	60.96	12	5-1546105-6
PRELIMINARY	SEE DETAIL V	TIN	76.20	15	5-1546105-5
PRELIMINARY	SEE DETAIL U	TIN	45.72	9	4-1546105-9
PRELIMINARY	SEE DETAIL T	TIN	40.64	8	4-1546105-8
PRELIMINARY	SEE DETAIL S	TIN	30.48	6	4-1546105-6
PRELIMINARY	SEE DETAIL R	TIN	20.32	4	4-1546105-4
PRELIMINARY	SEE DETAIL P	TIN	50.80	10	4-1546105-0
PRELIMINARY	SEE DETAIL N	TIN	30.48	6	3-1546105-6
PRELIMINARY	SEE DETAIL M	TIN	25.40	5	3-1546105-5
PRELIMINARY	SEE DETAIL L	TIN	20.32	4	3-1546105-4
PRELIMINARY	SEE DETAIL K	TIN	66.04	13	3-1546105-3
PRELIMINARY	SEE DETAIL J	TIN	50.80	10	3-1546105-0
	-	TIN	127.00	25	2-1546105-5
	-	TIN	121.92	24	2-1546105-4
	-	TIN	116.84	23	2-1546105-3
	-	TIN	111.76	22	2-1546105-2
	-	TIN	106.68	21	2-1546105-1
	-	TIN	101.60	20	2-1546105-0
	-	TIN	96.52	19	1-1546105-9
	-	TIN	91.44	18	1-1546105-8
	-	TIN	86.36	17	1-1546105-7
	-	TIN	81.28	16	1-1546105-6
	-	TIN	76.20	15	1-1546105-5
	-	TIN	71.12	14	1-1546105-4
	-	TIN	66.04	13	1-1546105-3
	-	TIN	60.96	12	1-1546105-2
	-	TIN	55.88	11	1-1546105-1
	-	TIN	50.80	10	1-1546105-0
	-	TIN	45.72	9	1546105-9
	-	TIN	40.64	8	1546105-8
	-	TIN	35.56	7	1546105-7
	-	TIN	30.48	6	1546105-6
	-	TIN	25.40	5	1546105-5
	-	TIN	20.32	4	1546105-4
	-	TIN	15.24	3	1546105-3
	-	TIN	10.16	2	1546105-2
	MARKING	CONTACT FINISH	A	NO OF POSN	PART NUMBER

THIS DRAWING IS A CONTROLLED DOCUMENT. DWN S.WELDON 03SEP2002  
 CHK C.RICHARD 03SEP2002  
 APVD C.RICHARD 03SEP2002

**STE** TE Connectivity

NAME: TERMINAL BLOCK VERTICAL PLUG  
 STACKING LEFT HAND  
 5.08mm PITCH

SIZE: A2 CAGE CODE: 00779 DRAWING NO: C-1546105 RESTRICTED TO: -

MATERIAL: 1 TOLERANCES UNLESS OTHERWISE SPECIFIED: 1

0 PLC ±0.3  
 1 PLC ±0.25  
 2 PLC ±  
 3 PLC ±  
 4 PLC ±  
 ANGLES ±2°  
 FINISH

PRODUCT SPEC: -  
 APPLICATION SPEC: -  
 WEIGHT: -

CUSTOMER DRAWING SCALE: 4:1 SHEET 1 OF 2 REV: C3

THIS DRAWING IS UNPUBLISHED. RELEASED FOR PUBLICATION 20  
 © COPYRIGHT 20 BY - ALL RIGHTS RESERVED.

LOC	DIST	REVISIONS					
FT	0	P	LTR	DESCRIPTION	DATE	DWN	APVD
		-		SEE SHEET 1	-	-	-

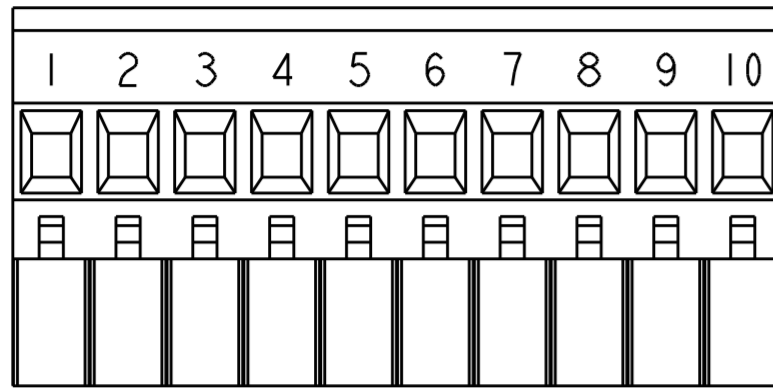

DETAIL J  
SCALE 2:1

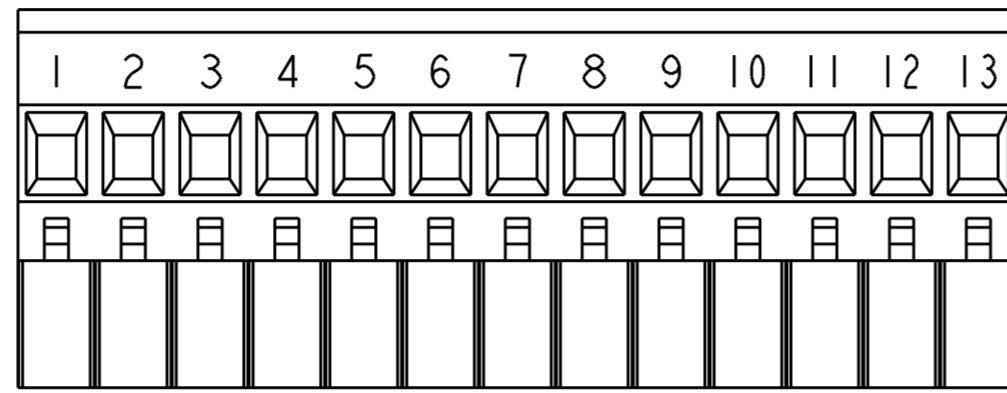

DETAIL K  
SCALE 2:1

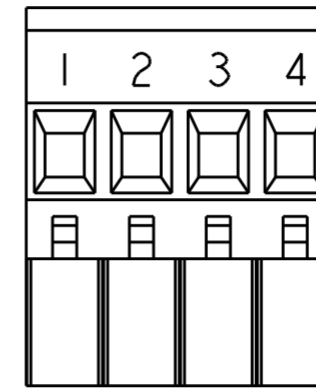

DETAIL L  
SCALE 2:1

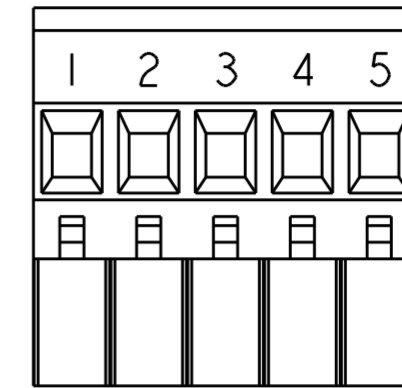

DETAIL M  
SCALE 2:1

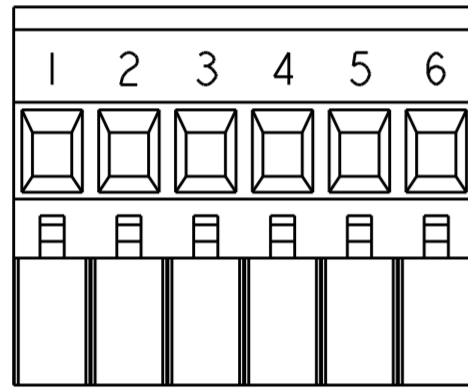

DETAIL N  
SCALE 2:1

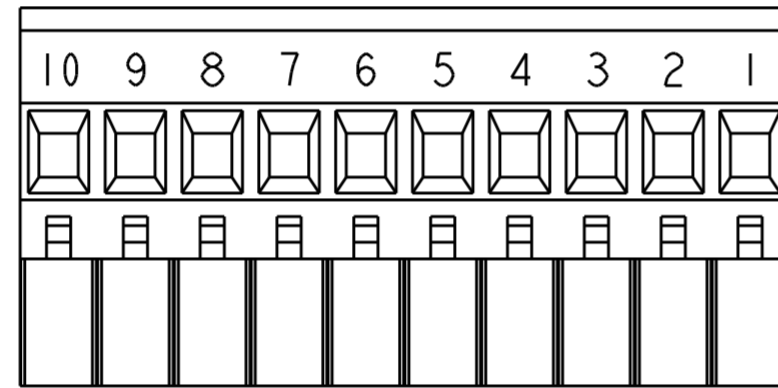

DETAIL P  
SCALE 2:1

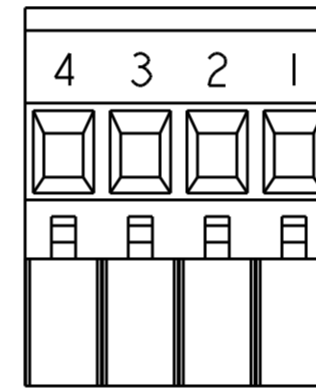

DETAIL R  
SCALE 2:1

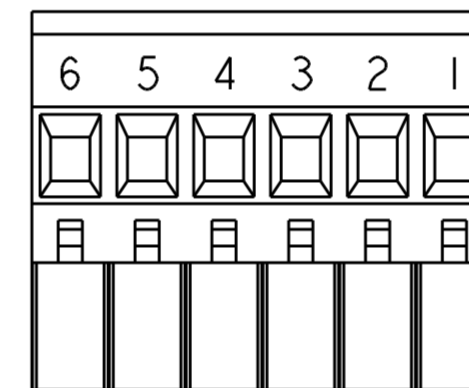

DETAIL S  
SCALE 2:1

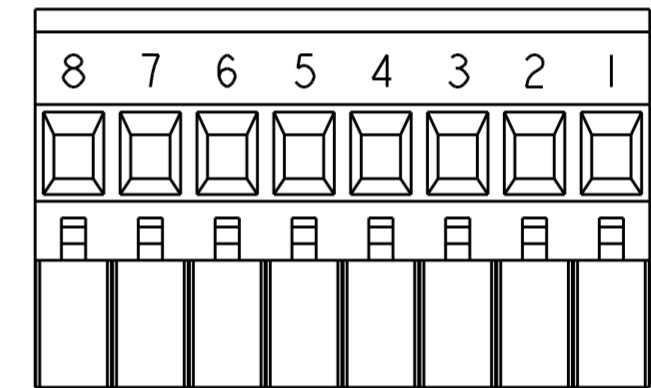

DETAIL T  
SCALE 2:1

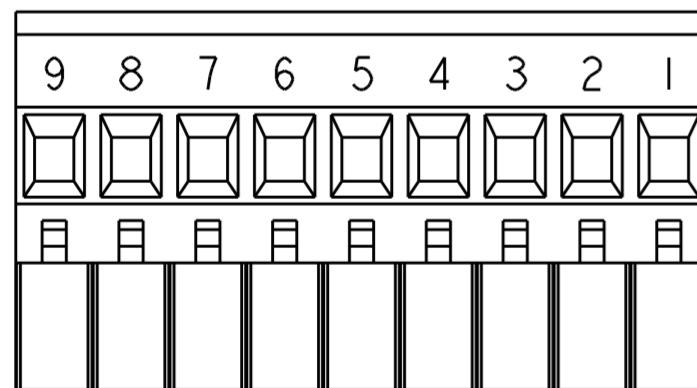

DETAIL U  
SCALE 2:1

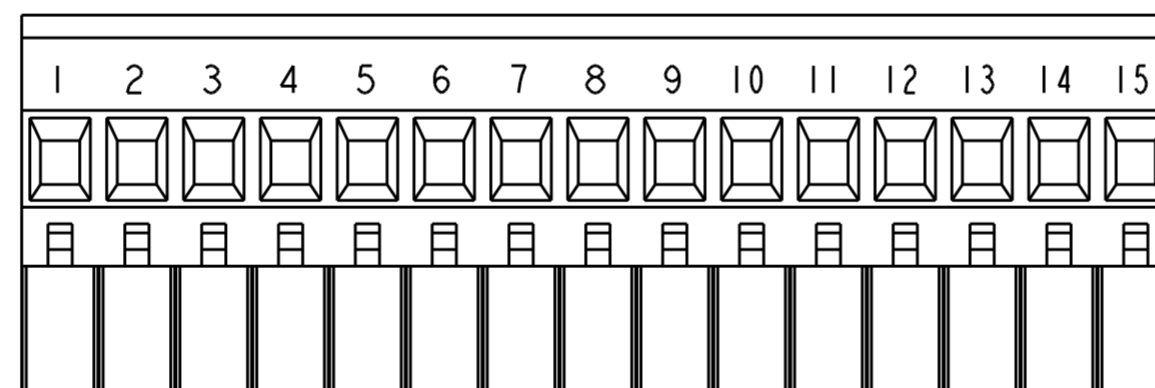

DETAIL V  
SCALE 2:1

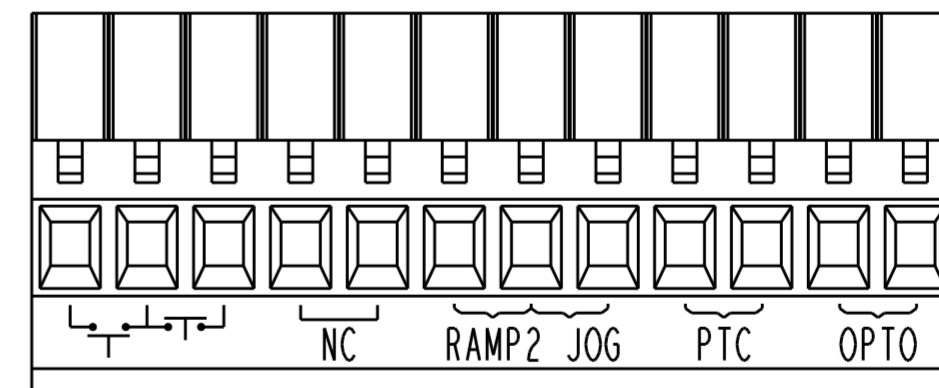

DETAIL W  
SCALE 2:1

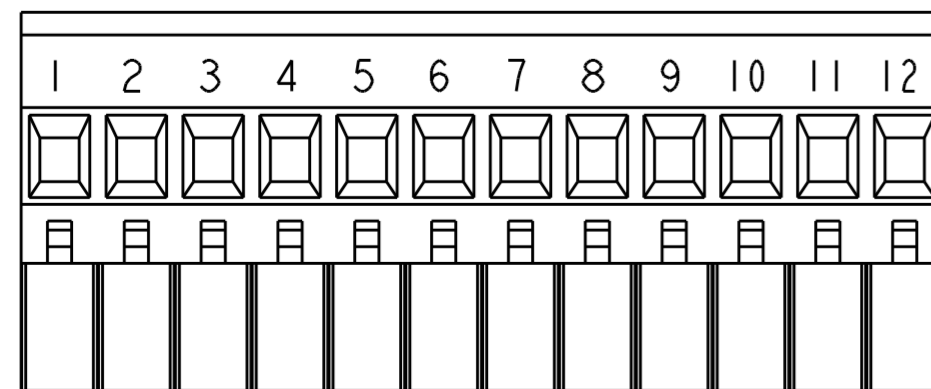

DETAIL X  
SCALE 2:1

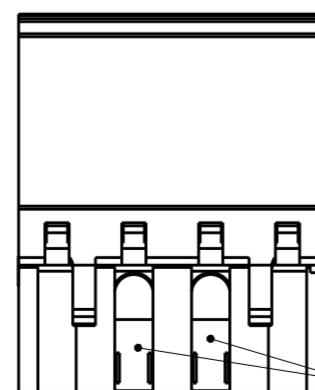

DETAIL Z  
SCALE 2:1

CODING KEYS

THIS DRAWING IS A CONTROLLED DOCUMENT.		DWN S.WELDON 03SEP2002	TE Connectivity
DIMENSIONS: mm		CHK C.RICHARD 03SEP2002	
TOLERANCES UNLESS OTHERWISE SPECIFIED:		APVD C.RICHARD 03SEP2002	NAME
0 PLC ±	1 PLC ±0.3	PRODUCT SPEC	TERMINAL BLOCK VERTICAL PLUG
2 PLC ±0.25	3 PLC ±	APPLICATION SPEC	STACKING LEFT HAND
4 PLC ±	ANGLES ±2°	FINISH	5.08mm PITCH
MATERIAL		WEIGHT	SIZE CAGE CODE DRAWING NO RESTRICTED TO
			A2 00779 C-1546105
		CUSTOMER DRAWING	SCALE 3:1 SHEET 2 OF 2 REV C3

## Данный компонент на территории Российской Федерации

### Вы можете приобрести в компании MosChip.

Для оперативного оформления запроса Вам необходимо перейти по данной ссылке:

<http://moschip.ru/get-element>

Вы можете разместить у нас заказ для любого Вашего проекта, будь то серийное производство или разработка единичного прибора.

В нашем ассортименте представлены ведущие мировые производители активных и пассивных электронных компонентов.

Нашей специализацией является поставка электронной компонентной базы двойного назначения, продукции таких производителей как XILINX, Intel (ex.ALTERA), Vicor, Microchip, Texas Instruments, Analog Devices, Mini-Circuits, Amphenol, Glenair.

Сотрудничество с глобальными дистрибьюторами электронных компонентов, предоставляет возможность заказывать и получать с международных складов практически любой перечень компонентов в оптимальные для Вас сроки.

На всех этапах разработки и производства наши партнеры могут получить квалифицированную поддержку опытных инженеров.

Система менеджмента качества компании отвечает требованиям в соответствии с ГОСТ Р ИСО 9001, ГОСТ РВ 0015-002 и ЭС РД 009

### Офис по работе с юридическими лицами:

105318, г.Москва, ул.Щербаковская д.3, офис 1107, 1118, ДЦ «Щербаковский»

Телефон: +7 495 668-12-70 (многоканальный)

Факс: +7 495 668-12-70 (доб.304)

E-mail: [info@moschip.ru](mailto:info@moschip.ru)

Skype отдела продаж:

moschip.ru

moschip.ru\_4

moschip.ru\_6

moschip.ru\_9