

Features

- Low Noise Figure
- High IP₃
- Single Supply +3 V, +5 V⁶
- RoHS* Compliant SOT-89 Package

Description

M/A-COM Technology's MAAL-010200 broadband gain stage is a GaAs MMIC amplifier in a lead-free SOT-89 surface mount plastic package. The MAAL-010200 employs a monolithic 1-stage self-biased design featuring a convenient 50 Ω input/output impedance that minimizes the number of external components required. Its broadband design provides usable performance from 500 to 3000 MHz. For operation below 500 MHz contact M/A-COM Technology's application group for support.

Functional Block Diagram

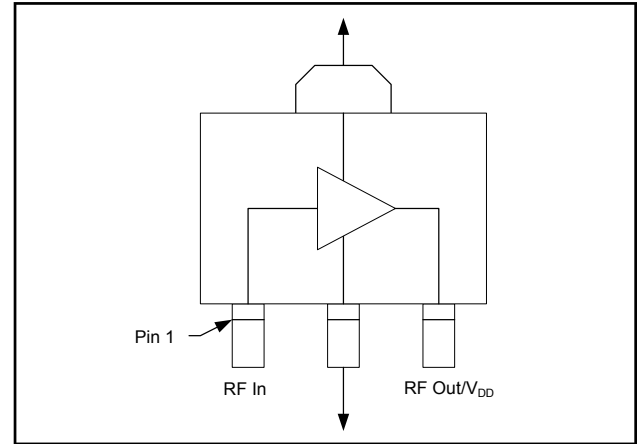

Pin Configuration

Pin	Pin Name	Description
1	RF In	RF Input
2	GND	Ground
3	RF Out/V _{DD}	RF Output & Voltage Bias

Ordering Information ^{1,2}

Part Number	Package
MAAL-010200 -TR3000	3000 piece reel
MAAL-010200-001SMB	Sample Test Board

1. Reference Application Note M513 for reel size information.
2. All sample boards include 5 loose parts.

Absolute Maximum Ratings ^{3,4,5}

Parameter	Absolute Maximum
RF Output Power	22 dBm
Voltage	5.5 volts
Operating Temperature	-40 °C to +85 °C
Storage Temperature	-65 °C to +150 °C

3. Exceeding any one or combination of these limits may cause permanent damage to this device.
4. M/A-COM Technology does not recommend sustained operation near these survivability limits.
5. Operating at 5 volts with no drain resistor will require the RF output power to be no greater than 10 dBm.

* Restrictions on Hazardous Substances, European Union Directive 2002/95/EC.

Miniature Broadband Gain Stage 70 - 3000 MHz

Rev. V1

Electrical Specifications: Freq. = 500 - 3000 MHz, T_A = 25°C, Z₀ = 50 Ω

Parameter	Test Conditions	Units	Bias Voltage			
			3 Volts		5 Volts ⁶	
			Min.	Typ.	Max.	Typ.
Gain	F = 0.9 GHz	dB	—	14	—	14
	F = 1.9 GHz		10	11	13	11
	F = 3.0 GHz		—	8	—	8.5
Noise Figure	F = 0.9 GHz	dB	—	1.3	—	1.45
	F = 1.9 GHz		—	1.4	2	1.4
	F = 3.0 GHz		—	1.45	—	1.5
Input Return Loss	F = 0.9 GHz	dB	—	7.5	—	7.5
	F = 1.9 GHz		—	11	—	11
	F = 3.0 GHz		—	14	—	14
Output Return Loss	F = 0.9 GHz	dB	—	19.5	—	20
	F = 1.9 GHz		—	22	—	21.5
	F = 3.0 GHz		—	20	—	23
Output P1dB	500 – 3000 MHz	dBm		17.5		—
Output IP ₃	500 – 3000 MHz	dBm		36		36
Current	—	mA	50	77	100	90

Baseline Application Schematic @ 3V, 5V

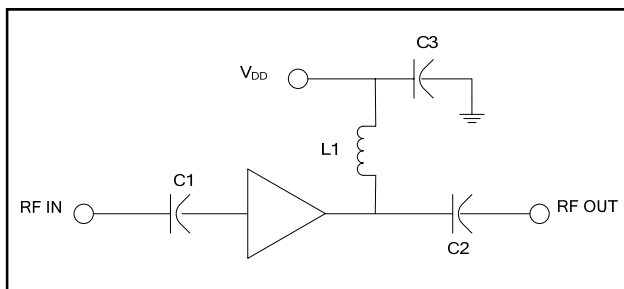

Component List @ 3V, 5V

Part	Value	Case Style	Purpose
C1,C2	39 pF	0402	DC Block
C3	0.1 μF	0402	RF Bypass
L1	12 nH	0402	RF Choke/Tuning

Recommended PCB Configuration @ 3V, 5V

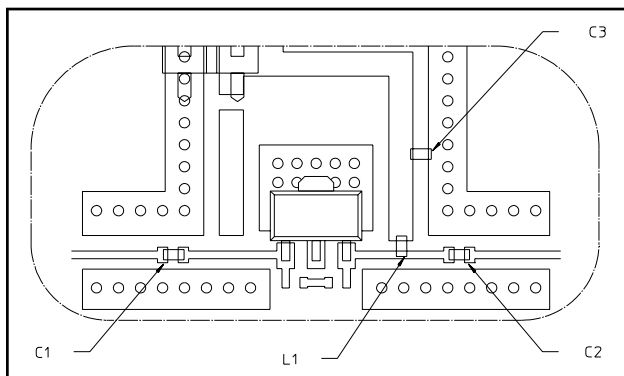

Handling Procedures

The following precautions should be observed to avoid damage:

Static Sensitivity

Gallium Arsenide Integrated Circuits are sensitive to electrostatic discharge (ESD) and can be damaged by static electricity. Proper ESD control techniques should be used when handling these devices.

Typical Performance Curves: $V_{DD} = 3\text{ V}$

Gain

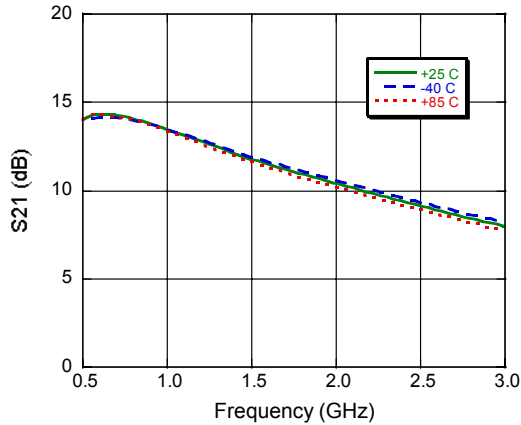

Input Return Loss

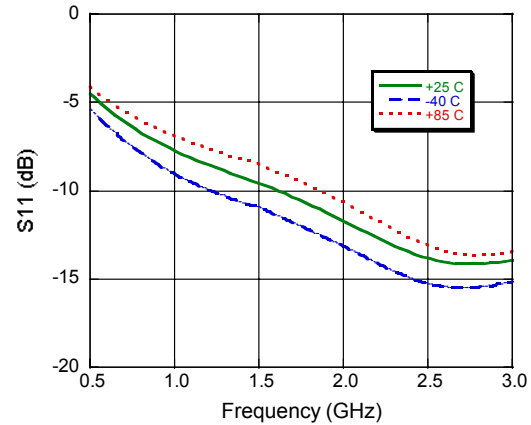

Output Return Loss

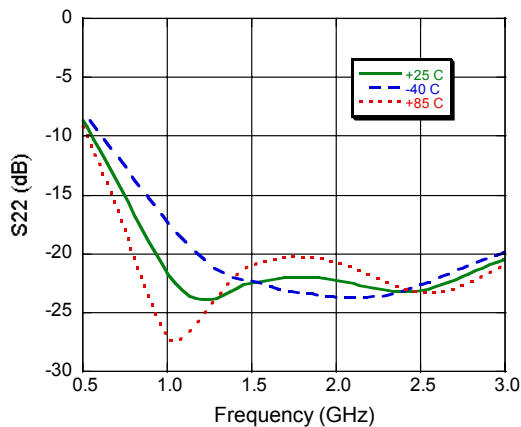

Noise Figure

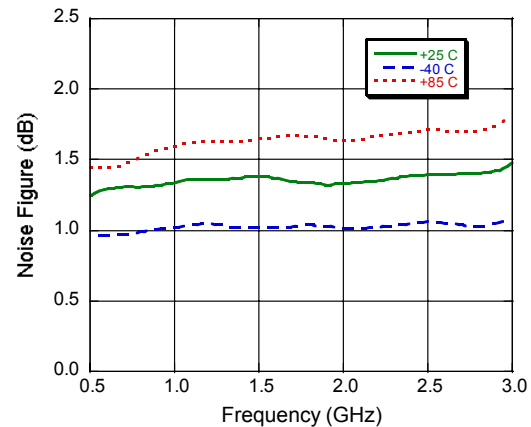

Typical Performance Curves: $V_{DD} = 3\text{ V}$

Output IP3, Input Power @ -12 dBm

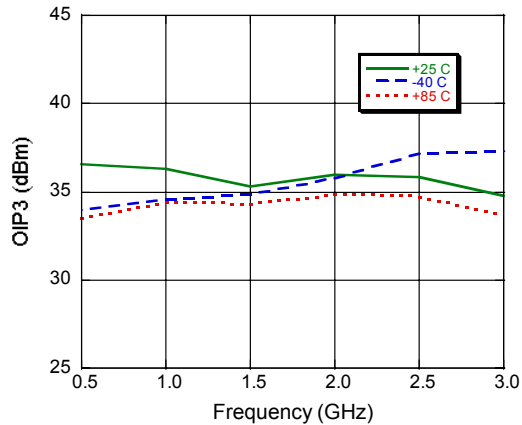

P1dB

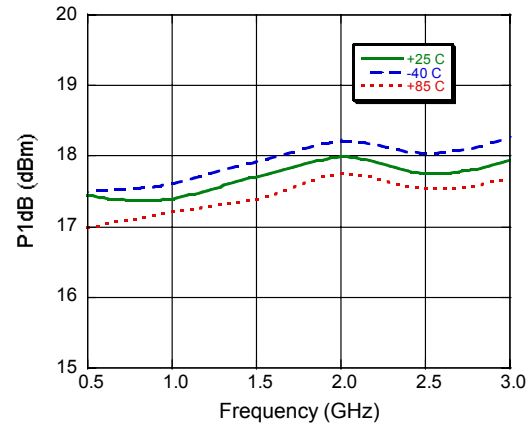

Current

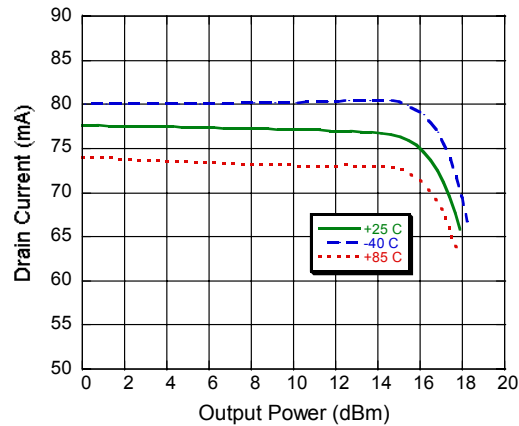

Typical Performance Curves: $V_{DD} = 5 V^6$

Gain

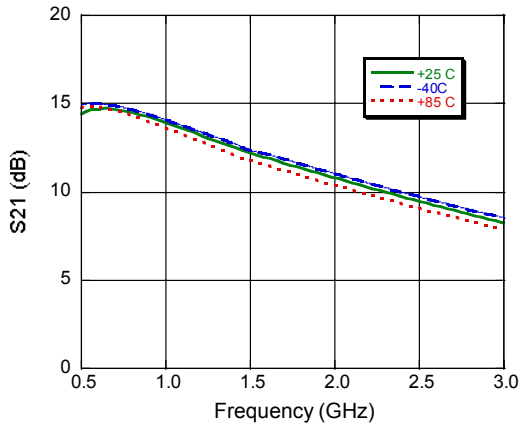

Input Return Loss

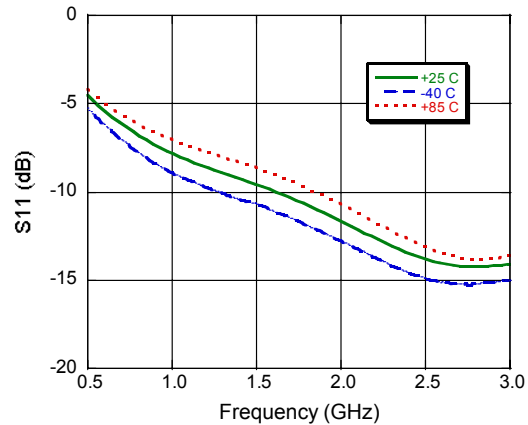

Output Return Loss

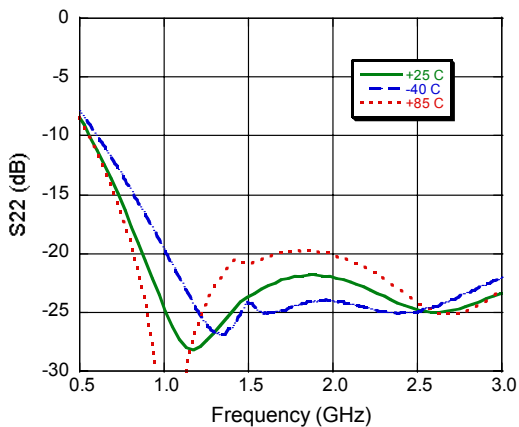

Noise Figure

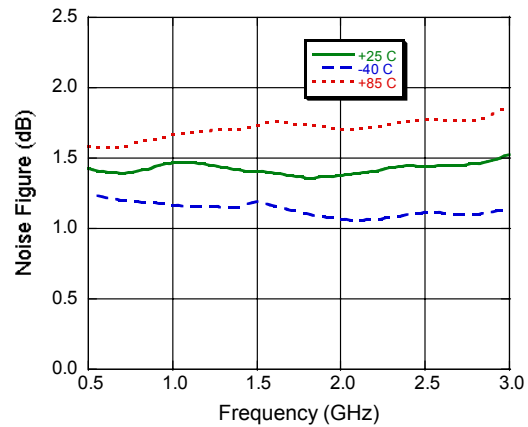

Output IP3, Input Power = -12 dBm

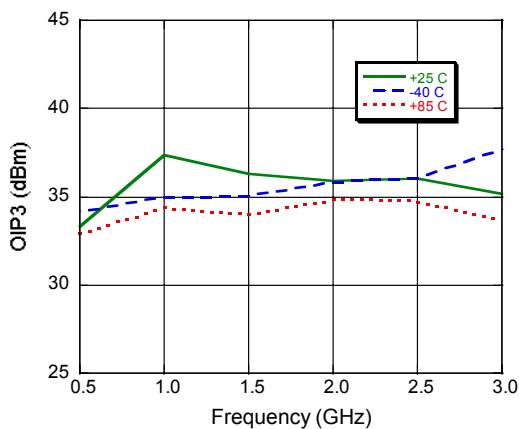

Current

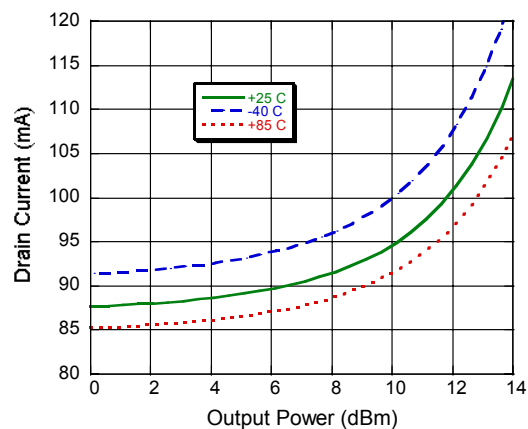

6. This device can run from a single 5 volt supply, but for 1M hour MTTF the output power must be no greater than 10 dBm unless using a series resistor on the drain. See Application note 7 on page 7.

5

ADVANCED: Data Sheets contain information regarding a product M/A-COM Technology Solutions is considering for development. Performance is based on target specifications, simulated results, and/or prototype measurements. Commitment to develop is not guaranteed.
PRELIMINARY: Data Sheets contain information regarding a product M/A-COM Technology Solutions has under development. Performance is based on engineering tests. Specifications are typical. Mechanical outline has been fixed. Engineering samples and/or test data may be available. Commitment to produce in volume is not guaranteed.

• **North America** Tel: 800.366.2266 • **Europe** Tel: +353.21.244.6400
• **India** Tel: +91.80.43537383 • **China** Tel: +86.21.2407.1588
Visit www.macomtech.com for additional data sheets and product information.

M/A-COM Technology Solutions Inc. and its affiliates reserve the right to make changes to the product(s) or information contained herein without notice.

Lead-Free SOT-89†

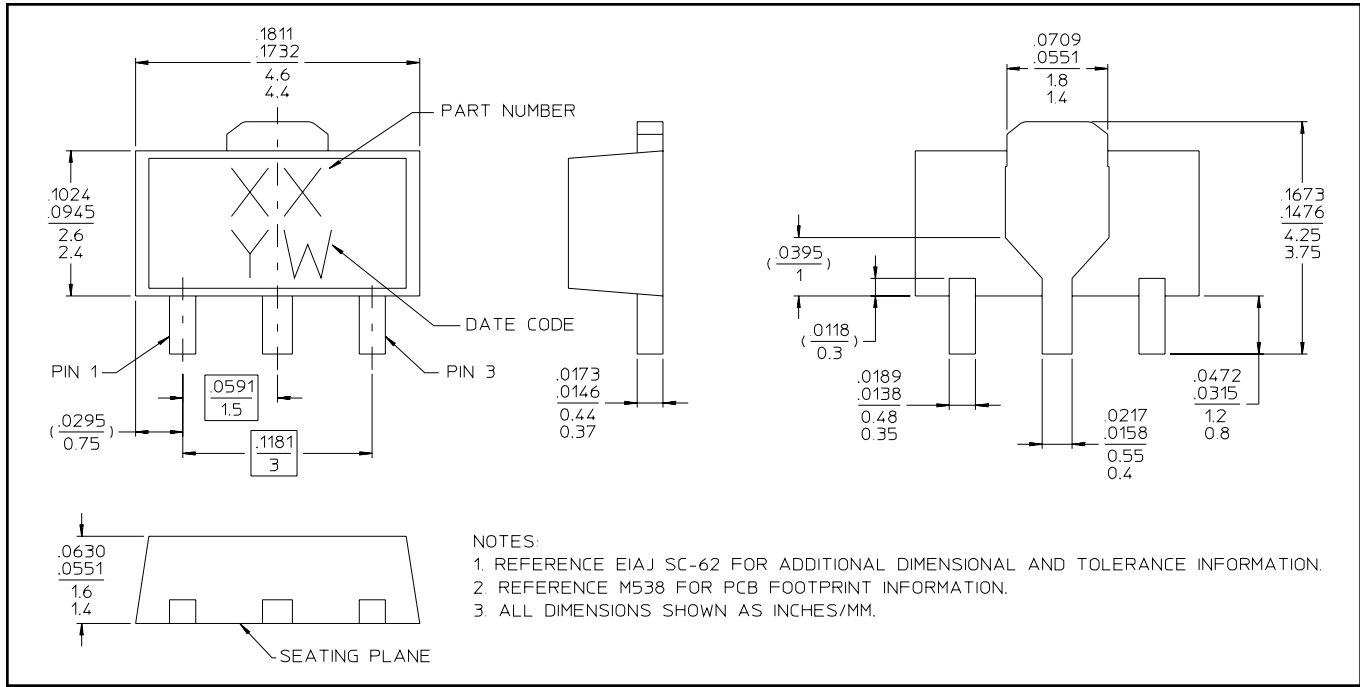

† Reference Application Note M538 for lead-free solder reflow recommendations.
Meets JEDEC moisture sensitivity level 1 requirements.
Plating is 100% matte tin over copper.

5 Volt Application Section for operation above 10 dBm output power

Application Layout Schematic @ 5V ⁷

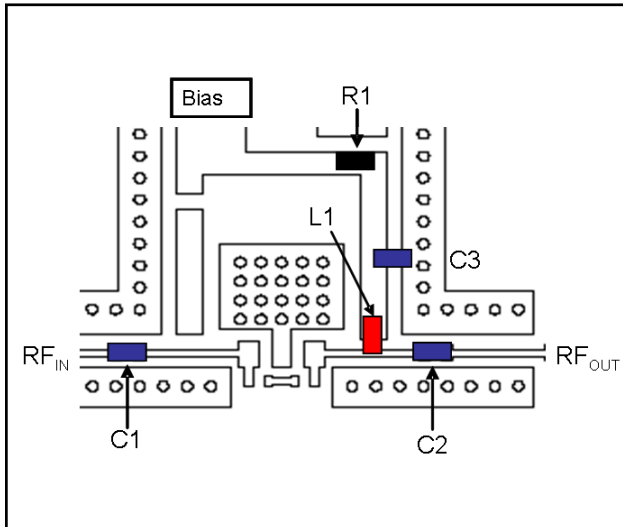

7. The addition of a 27 Ω series resistor on the drain line allows for 5 volt operation above 10 dBm output power, but no greater than 22 dBm of output power.

Component List @ 5V

Part	Value	Case Style	Purpose
C1	39 pF	0402	Input DC Block
C2	39 pF	0402	Output DC Block
C3	0.1 μ F	0402	RF Bypass
L1	12 nH	0805	RF Choke/Tuning
R1	27 Ω	0402	Voltage Drop

Application Schematic @ 5V

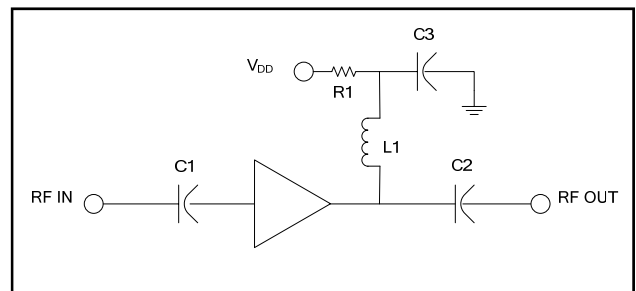

5 Volt Application Section for operation above 10 dBm output power

Typical Performance Curves: $V_{DD} = 5\text{ V}$

Gain

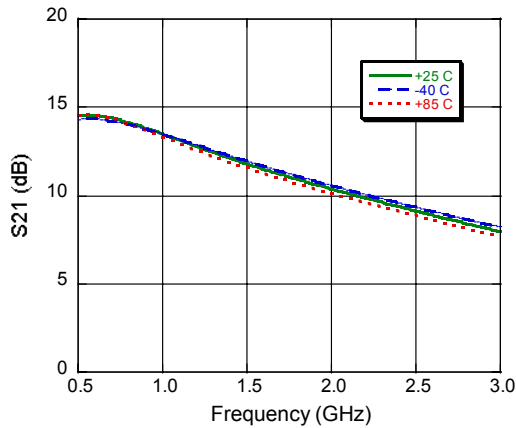

Input Return Loss

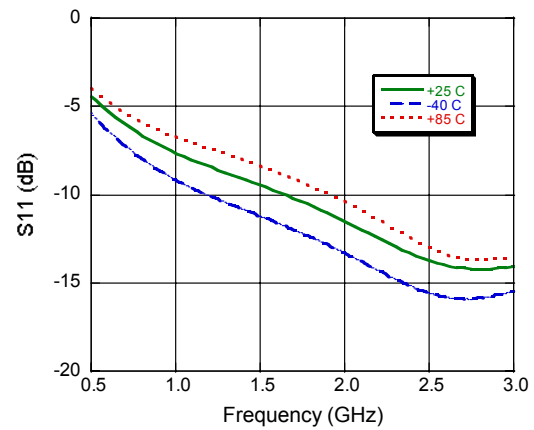

Output Return Loss

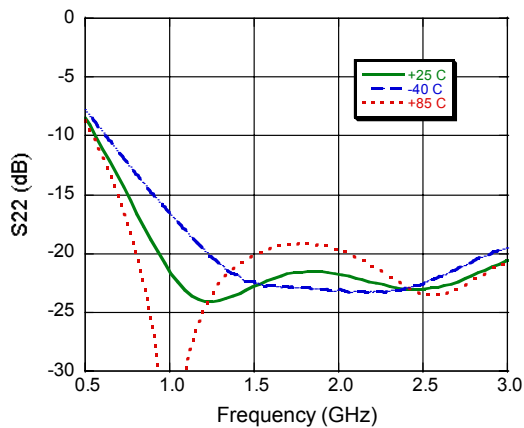

Noise Figure

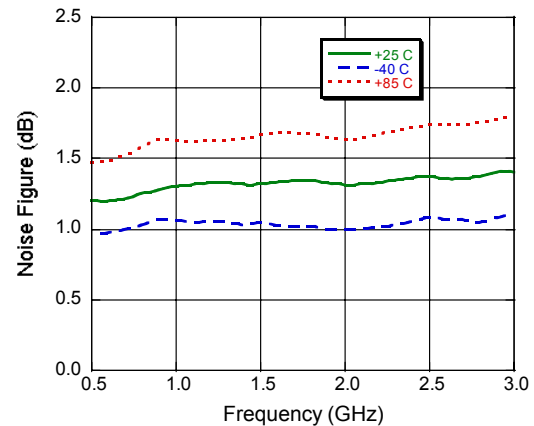

5 Volt Application Section for operation above 10 dBm output power

Typical Performance Curves: $V_{DD} = 5\text{ V}$

Output IP3, Input Power @ -12 dBm

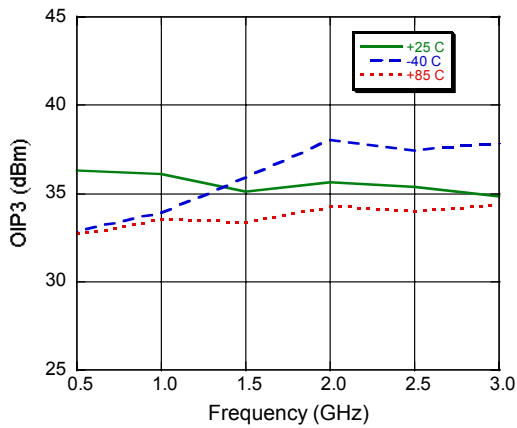

P1dB

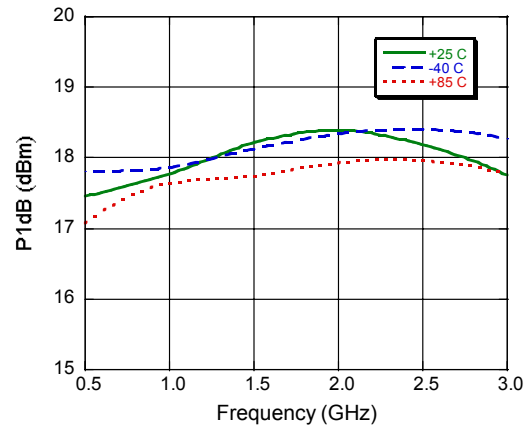

Current

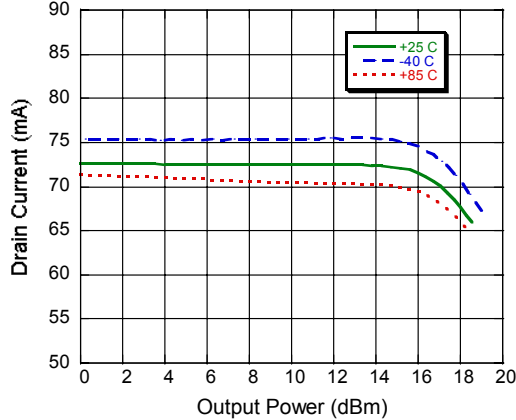

Данный компонент на территории Российской Федерации

Вы можете приобрести в компании MosChip.

Для оперативного оформления запроса Вам необходимо перейти по данной ссылке:

<http://moschip.ru/get-element>

Вы можете разместить у нас заказ для любого Вашего проекта, будь то серийное производство или разработка единичного прибора.

В нашем ассортименте представлены ведущие мировые производители активных и пассивных электронных компонентов.

Нашей специализацией является поставка электронной компонентной базы двойного назначения, продукции таких производителей как XILINX, Intel (ex.ALTERA), Vicor, Microchip, Texas Instruments, Analog Devices, Mini-Circuits, Amphenol, Glenair.

Сотрудничество с глобальными дистрибьюторами электронных компонентов, предоставляет возможность заказывать и получать с международных складов практически любой перечень компонентов в оптимальные для Вас сроки.

На всех этапах разработки и производства наши партнеры могут получить квалифицированную поддержку опытных инженеров.

Система менеджмента качества компании отвечает требованиям в соответствии с ГОСТ Р ИСО 9001, ГОСТ РВ 0015-002 и ЭС РД 009

Офис по работе с юридическими лицами:

105318, г.Москва, ул.Щербаковская д.3, офис 1107, 1118, ДЦ «Щербаковский»

Телефон: +7 495 668-12-70 (многоканальный)

Факс: +7 495 668-12-70 (доб.304)

E-mail: info@moschip.ru

Skype отдела продаж:

moschip.ru

moschip.ru_4

moschip.ru_6

moschip.ru_9