

Small-sized Class-D Speaker Amplifiers

Filter-Less Class-D Monaural Speaker Amplifier

BD27400GUL

General Description

BD27400GUL is a low voltage drive class-D monaural speaker amplifier that was developed for cellular telephones, mobile audio products and the others. The LC filter of the speaker output is unnecessary and the external part can compose a speaker amplifier at three. Because the efficiency is high and is low consumption power with the class-D operation, it is the optimal for the application of the battery drive. Also Current consumption of 0 μ A when standby and fast transitions from standby to active with little pop noise make it is suitable for applications that switch repeatedly between suspended and active.

Features

- High output power
2.5W typ.(VDD=5V, RL=4 Ω , THD+N=10%, BTL)
- Very small package 9-Pin WL-CSP
- Gain selectable by external resistor
- LC Filter less
- Protection circuitry
(Short protection, Thermal shutdown, Under voltage lockout)
- Analogue differential input / PWM digital output
- Pop noise suppression circuitry

Key Specifications

- Operating voltage Range: 2.5V to 5.5V
- Circuit current(No signal): 2.9mA(Typ)
- Circuit current(Stand by): 0.1 μ A(Typ)
- Output Power(RL=8 Ω): 0.85W(Typ)
- Output Power(RL=4 Ω): 2.5W(Typ)
- Start-up time: 3.0msec(Typ)
- Operating Temperature Range: -40°C to +85°C

Package(s)

VCSP50L1

W(Typ) x D(Typ) x H(Max)
1.50mm x 1.50mm x 0.55mm



Applications

- Mobile phone, Smart phone, Digital video camera

Typical Application Circuit(s)

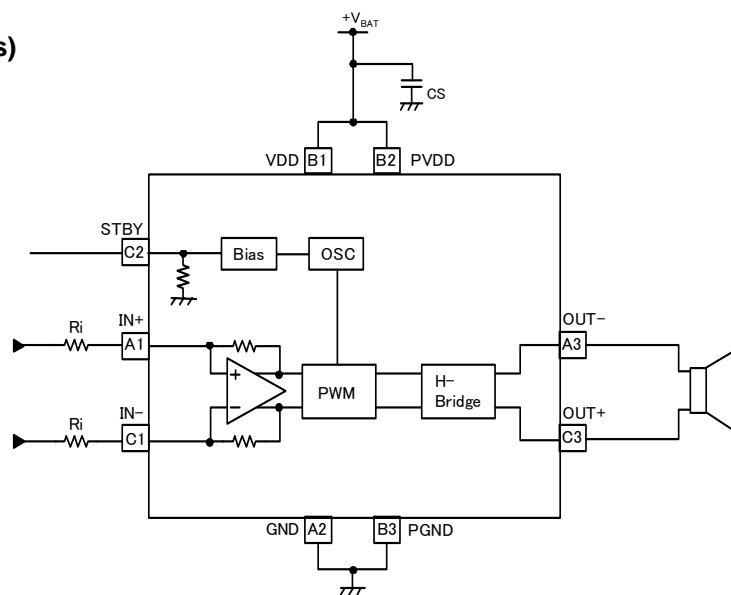

Figure 1. Application circuit

Pin Configuration(s)

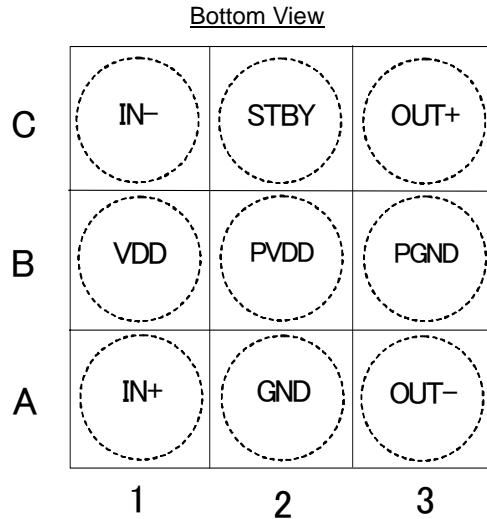

Figure.2 Pin configuration

Pin Description(s)

No.	Name	I/O	Function
A1	IN+	I	Positive input terminal
A2	GND	P	GND terminal (Connect to PGND terminal)
A3	OUT-	O	Negative output terminal
B1	VDD	P	Power supply terminal (Connect to PVDD terminal)
B2	PVDD	P	Power supply terminal (Connect to VDD terminal)
B3	PGND	P	Power GND terminal (Connect to GND terminal)
C1	IN-	I	Negative input terminal
C2	STBY	I	Stand by control terminal
C3	OUT+	O	Positive output terminal

※Connect VDD(B1) and PVDD(B2) on PCB board, and use a single power supply.

Block Diagram(s)

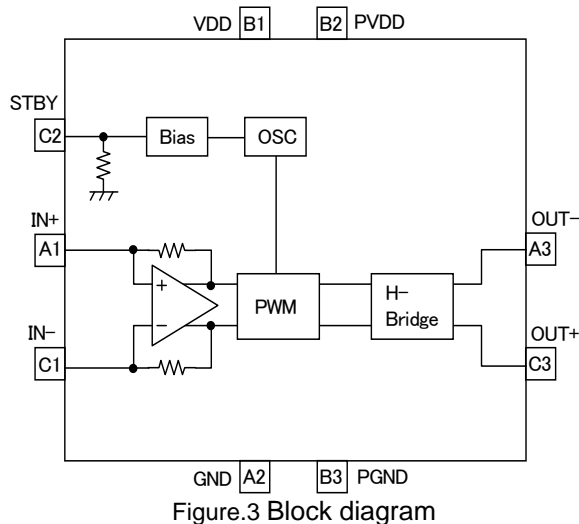

Absolute Maximum Ratings(Ta = 25°C)

Parameter	Symbol	Rating	Unit
Power Supply Voltage	VDDmax	7.0	V
Power Dissipation	Pd	0.69 ^(Note 1)	W
STBY Terminal Input Voltage Range	Vstby	-0.3 to VDD+0.3	V
IN+, IN- Terminal Voltage Range	Vin	-0.3 to VDD+0.3	V
Storage Temperature Range	Tstg	-55 to +150	°C
Maximum Junction Temperature	Tjmax	150	°C
Operating Temperature Range	Topr	-40 to +85	°C

(Note 1) Derating is done 5.52 mW/°C for operating above Ta ≥ 25°C (Mount on 1-layer 50.0mm x 58.0mm x 1.6mm board)

Caution: Operating the IC over the absolute maximum ratings may damage the IC. The damage can either be a short circuit between pins or an open circuit between pins and the internal circuitry. Therefore, it is important to consider circuit protection measures, such as adding a fuse, in case the IC is operated over the absolute maximum ratings.

Recommended Operating Conditions(Ta= -40°C to +85°C)

Parameter	Symbol	Min	Typ	Max	Unit
Power Supply Voltage	VDD	2.5	3.6	5.5	V
Common Mode Input Voltage Range	VIC	+0.5	-	VDD-0.8	V

Electrical Characteristics(Unless otherwise specified Ta=25°C.VDD=3.6V.RL=8Ω.BTL Connection)

Parameter	Symbol	Min	Typ	Max	Unit	Conditions	
Circuit current (No signal)	I _{CC}	-	2.9	5.4	mA	Active mode, No load	
Circuit current (Standby)	I _{STBY}	-	0.1	-	μA	Standby mode	
Output power 1	P _{O1}	450	680	-	mW	8 Ω, f=1kHz, THD+N=1% *1	
Output power 2	P _{O2}	550	850	-	mW	8 Ω, f=1kHz, THD+N=10% *1	
Output power 3	P _{O3}	-	2.5	-	W	4 Ω, f=1kHz, THD+N=10% *1	
Voltage gain	Gain	$\frac{285k\Omega}{R_i}$	$\frac{300k\Omega}{R_i}$	$\frac{315k\Omega}{R_i}$	$\frac{V}{V}$	BTL, RL=100kΩ	
Total harmonic distortion	THD+N	-	0.18	-	%	8 Ω, f=1kHz, 0.4W	
Output noise voltage	V _{no}	-	40	-	μVrms	A-weighting	
Power supply ripple rejection ratio	PSRR	-	64	-	dB	0.1Vp-p, f=217Hz	
Common mode rejection ratio	CMRR	-	55	-	dB	0.1Vp-p, f=217Hz	
Input impedance	Z _{in}	-	150	-	kΩ		
Switching Frequency	f _{OSC}	200	250	300	kHz	—	
Start-up time	T _{on}	1	3	5	msec	—	
STBY threshold voltage	High level	V _{STBYH}	1.4	-	VDD	V	Active mode
	Low level	V _{STBYL}	0	-	0.4	V	Stand by mode
STBY input impedance	R _{STBY}	210	300	390	kΩ		

*1: Band-width = 400~30kHz, BTL=Bridge Tied Load (Voltage between A3-C3.)

«Gain adjustment»

Please use a gain adjustment below 26dB (Input Resistor Ri ≥ 15kΩ)

Typical Performance Curves

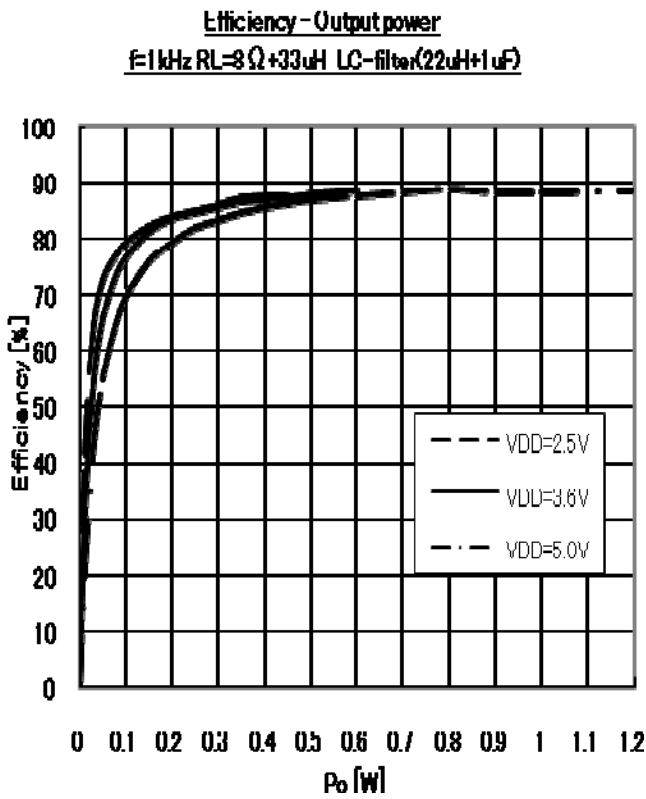

Figure.4

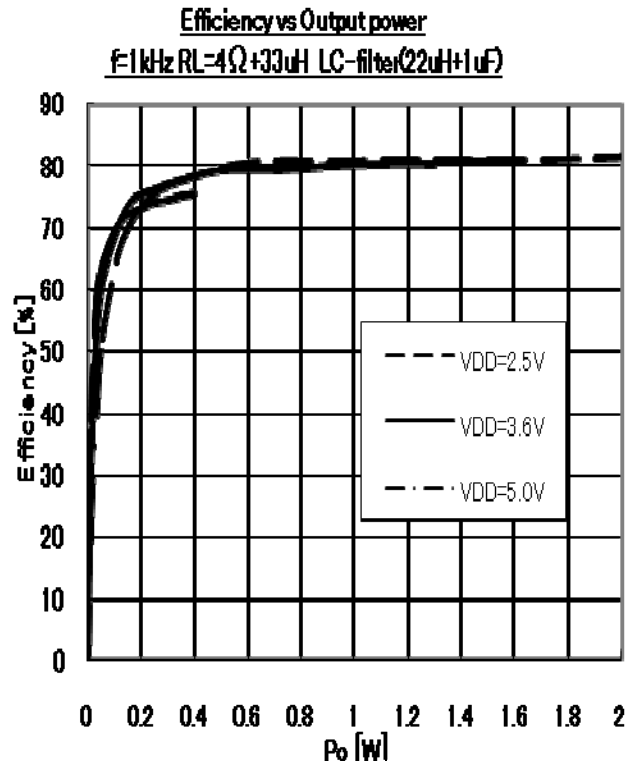

Figure.5

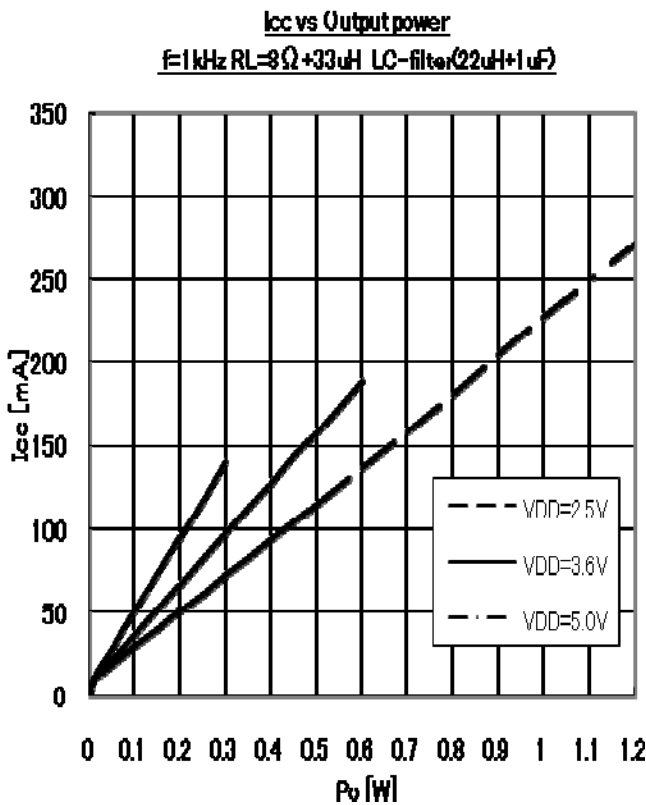

Figure.6

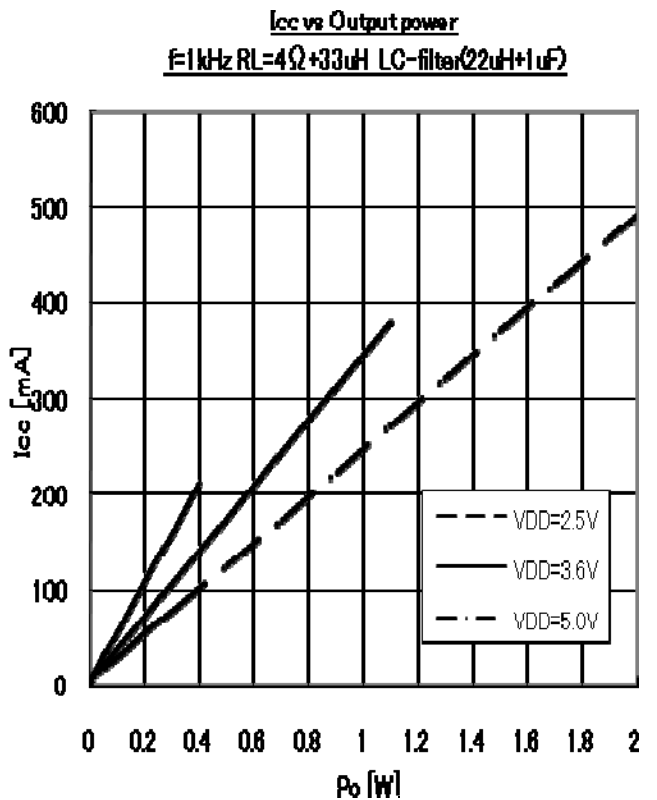

Figure.7

Typical Performance Curves - continued

Powerdissipation vs Output power
f=1kHz RL=8Ω+33uH LC-filter(22uH+1uF)

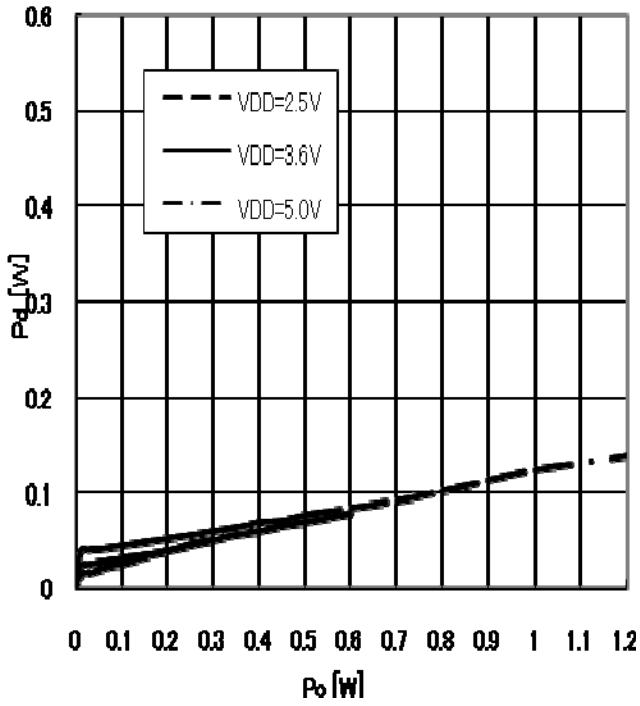

Figure.8

Powerdissipation vs Output power
f=1kHz RL=4Ω+33uH LC-filter(22uH+1uF)

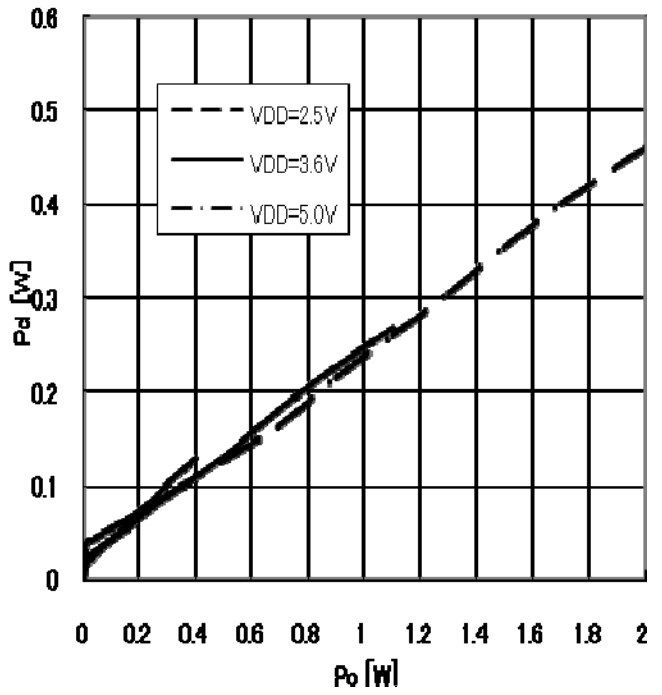

Figure.9

Icc - VDD
No load, No signal

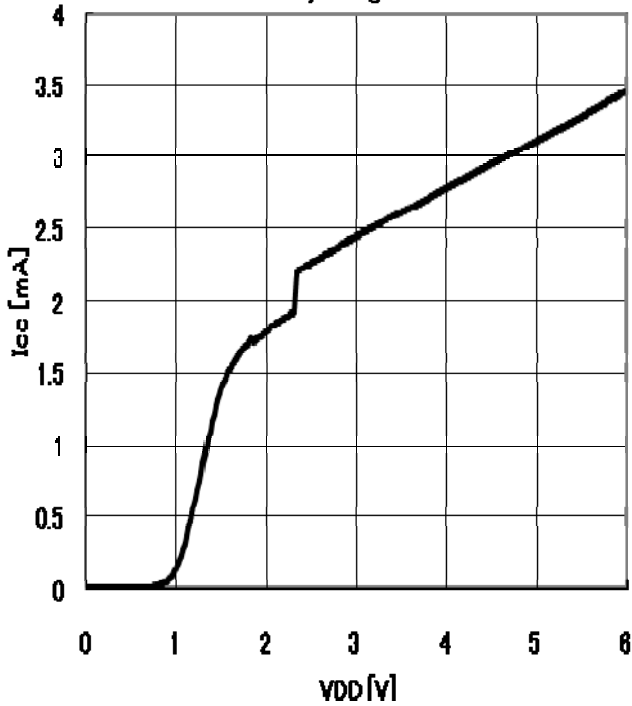

Figure.10

Istby - VDD

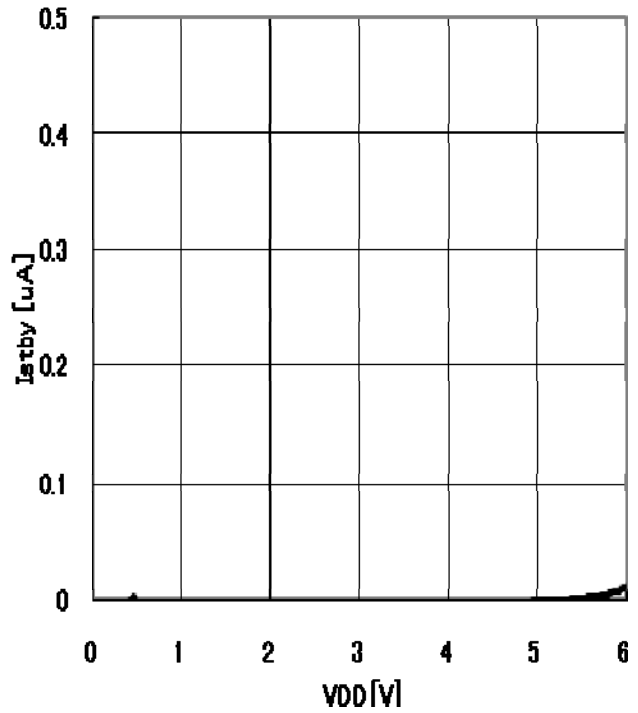

Figure.11

Typical Performance Curves - continued

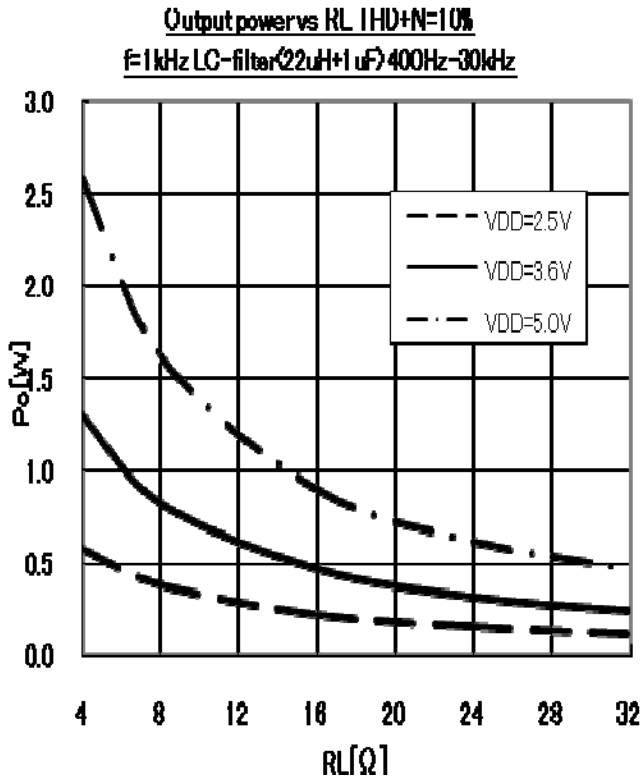

Figure.12

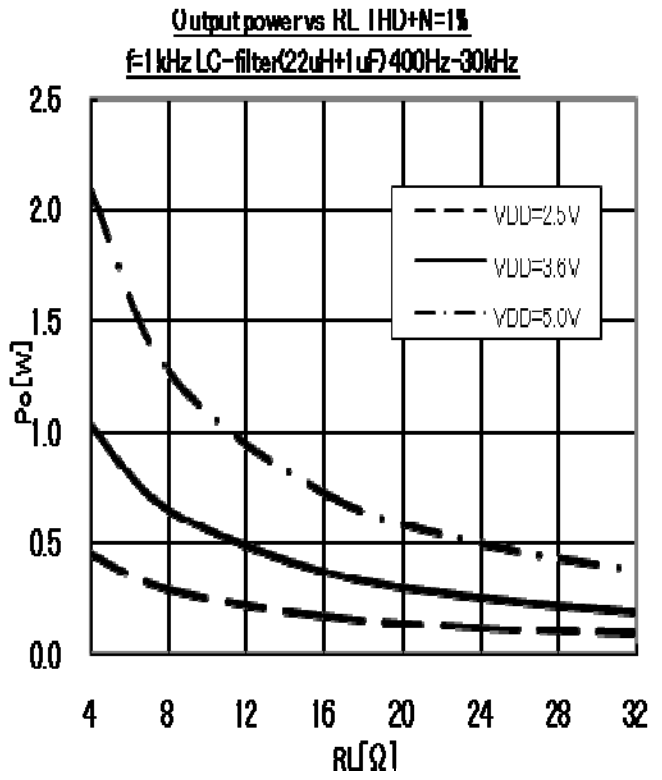

Figure.13

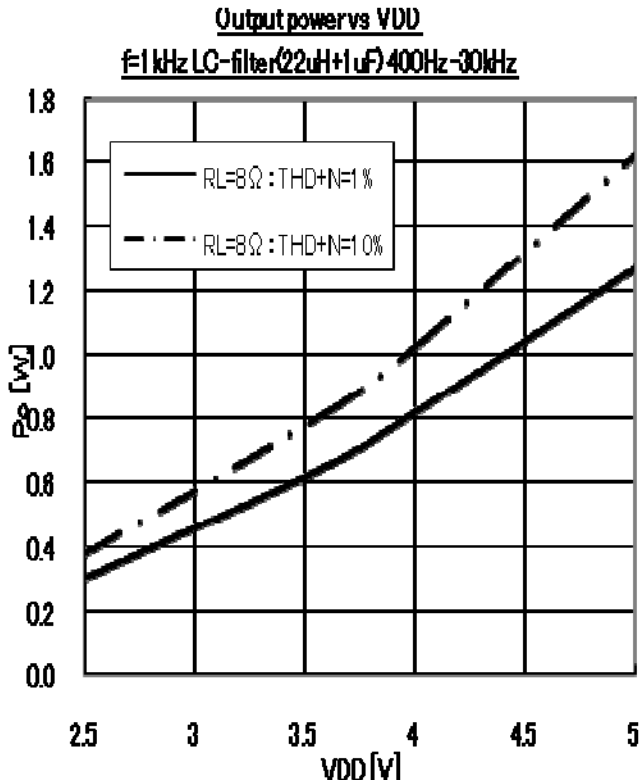

Figure.14

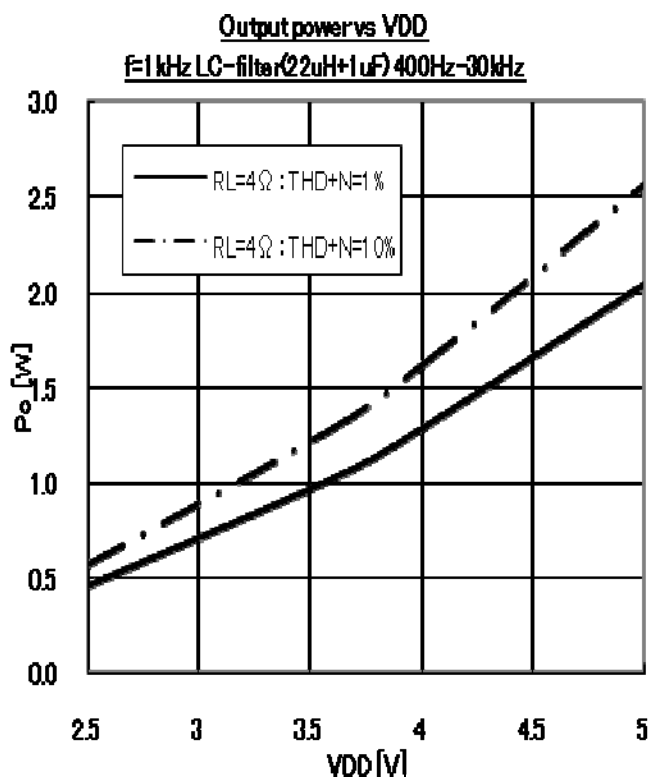

Figure.15

Typical Performance Curves - continued

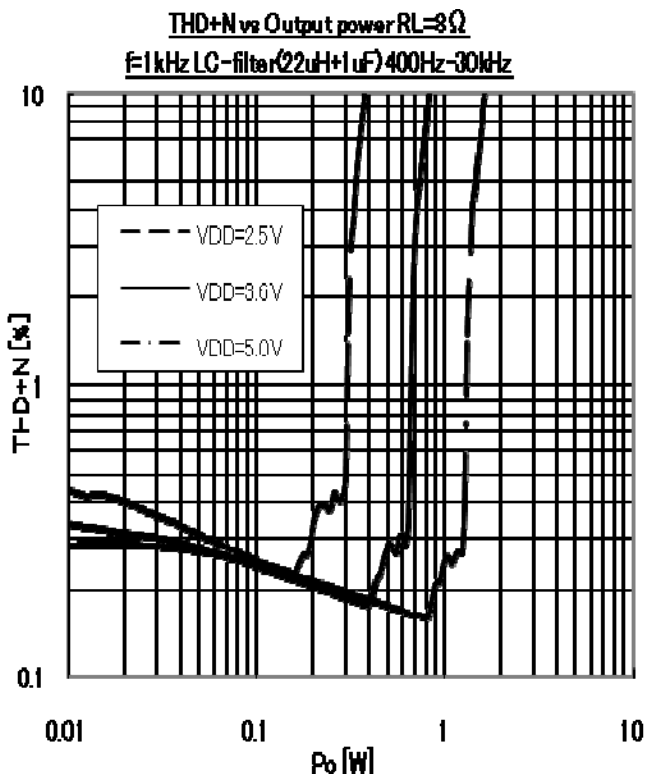

Figure.16

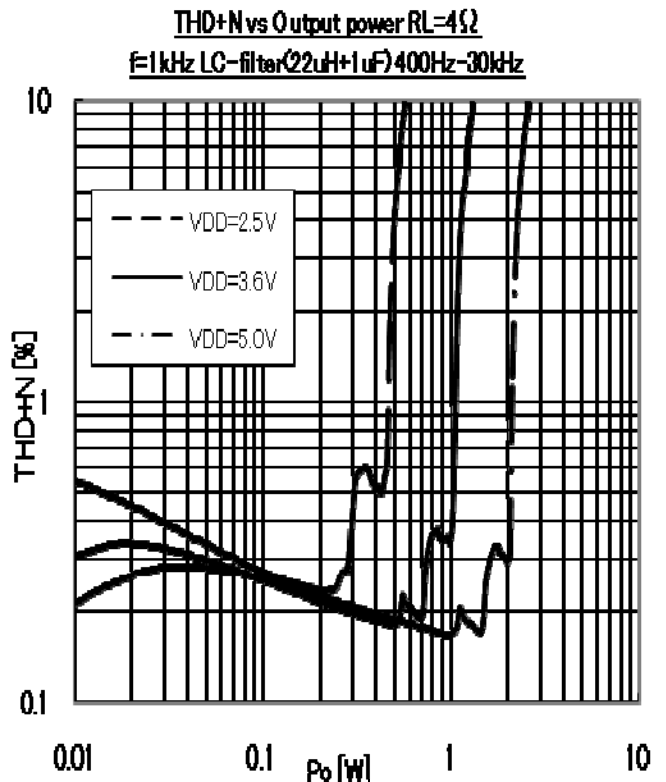

Figure.17

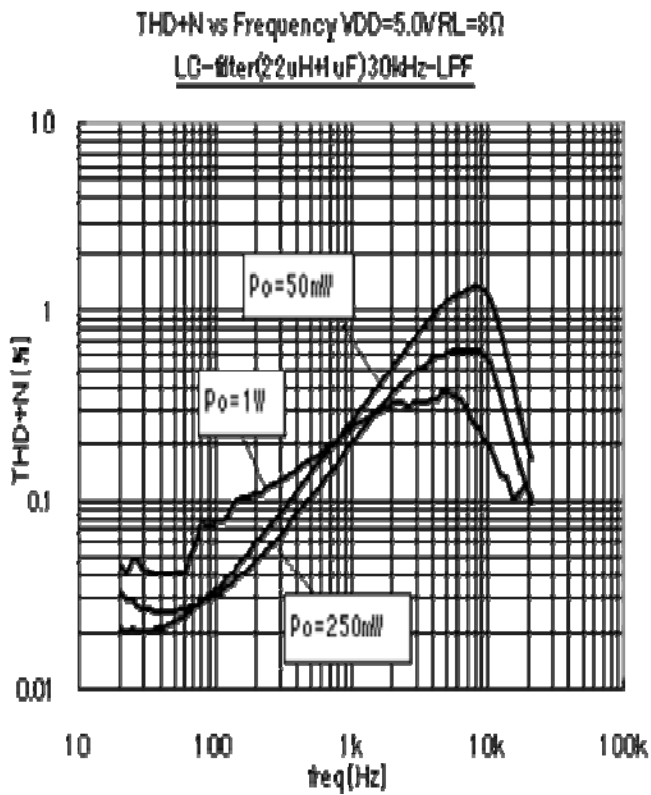

Figure.18

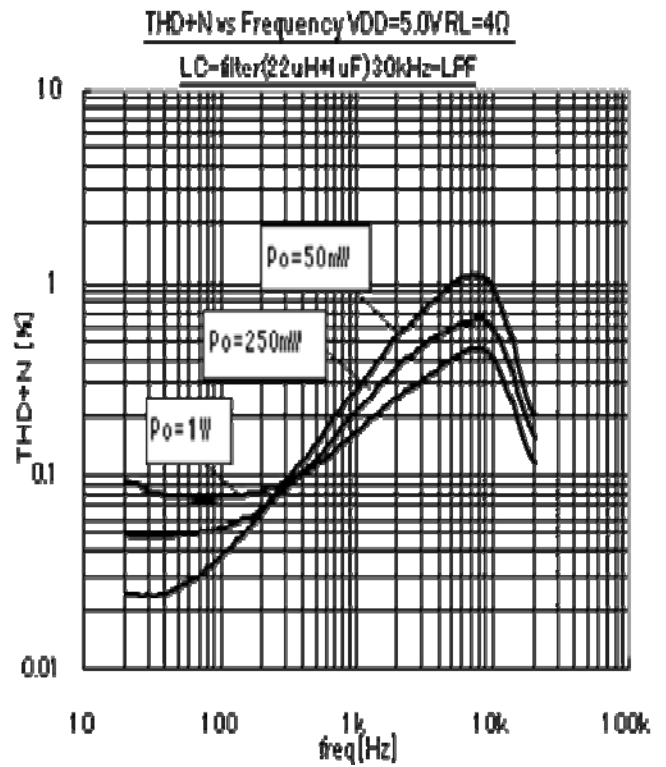

Figure.19

Typical Performance Curves - continued

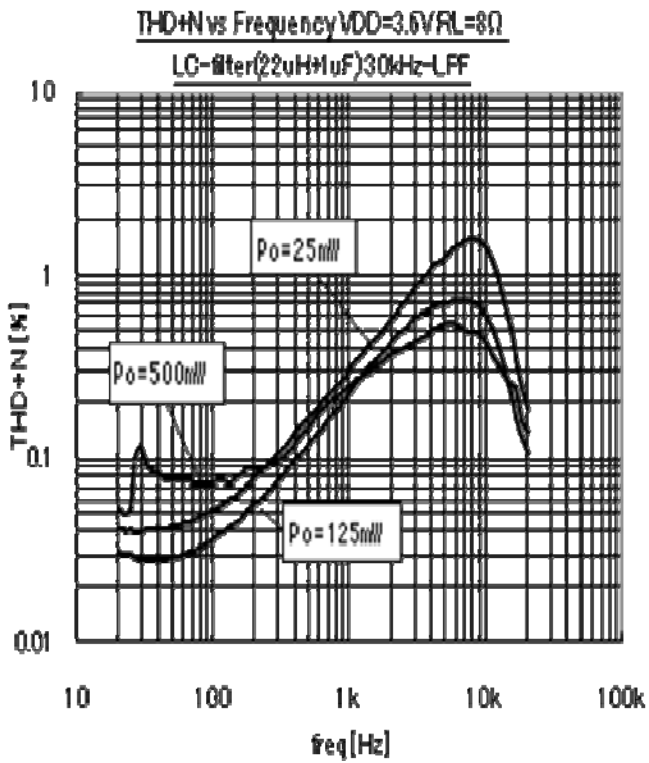

Figure.20

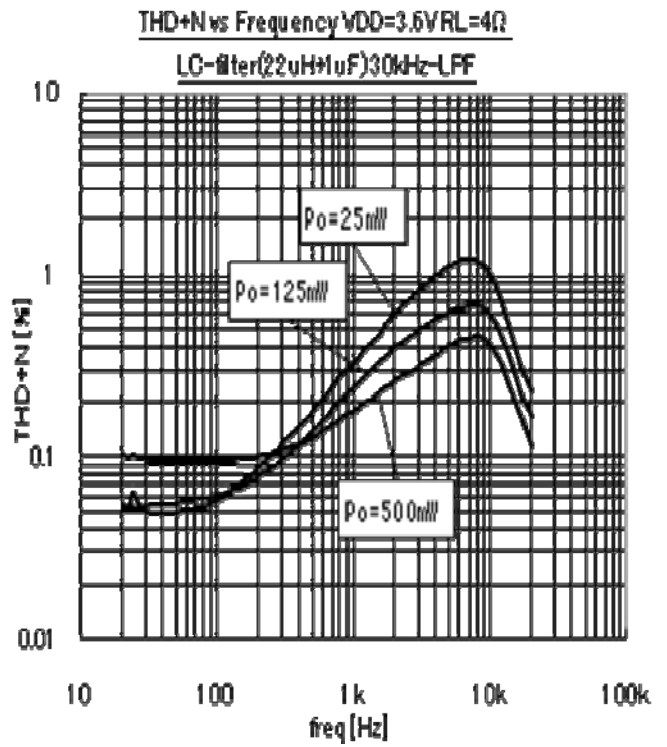

Figure.21

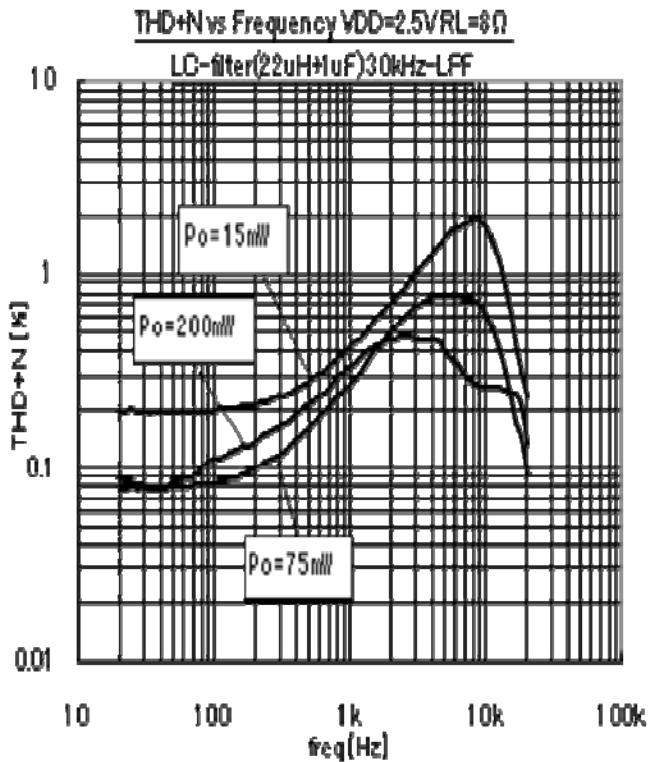

Figure.22

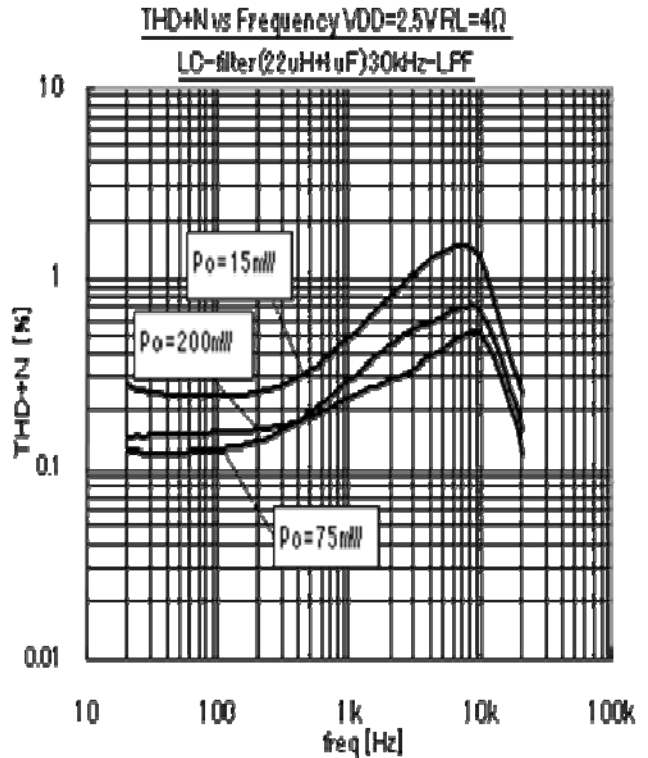

Figure.23

Typical Performance Curves - continued

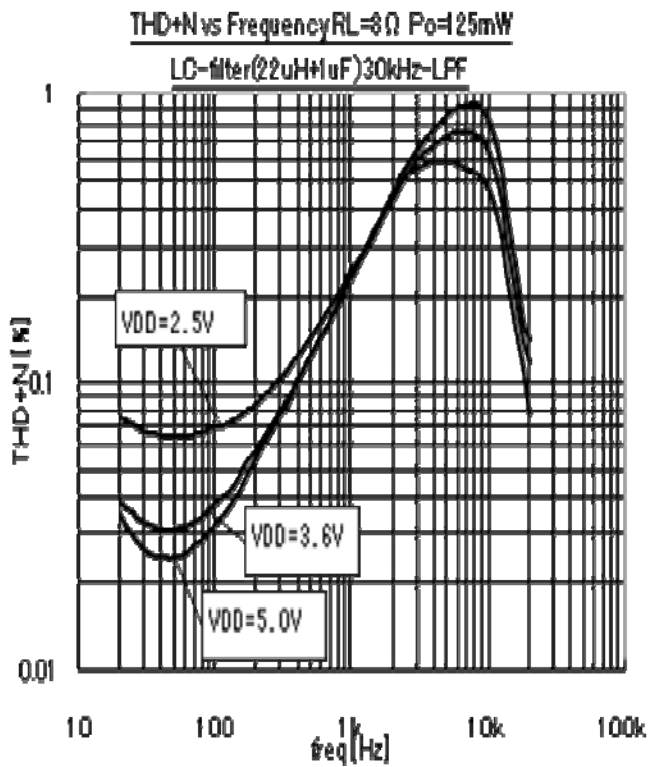

Figure.24

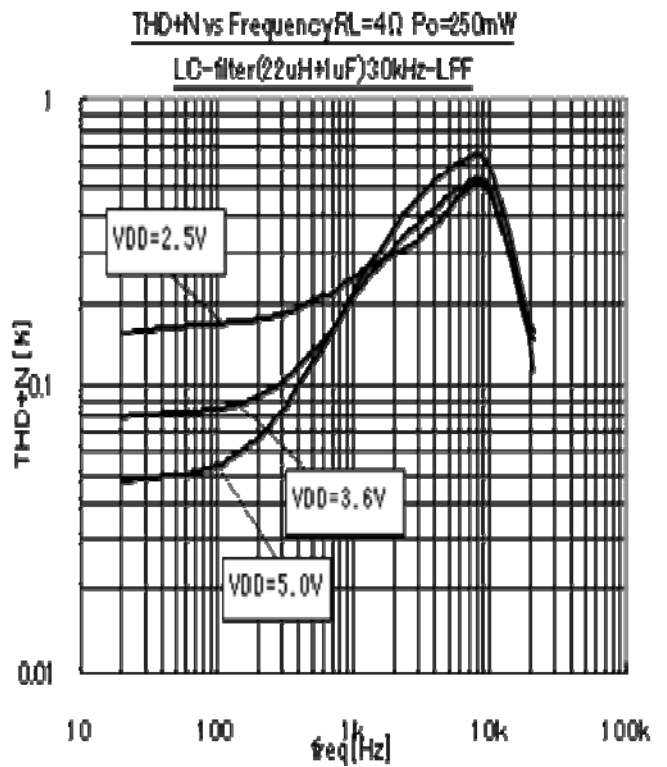

Figure.25

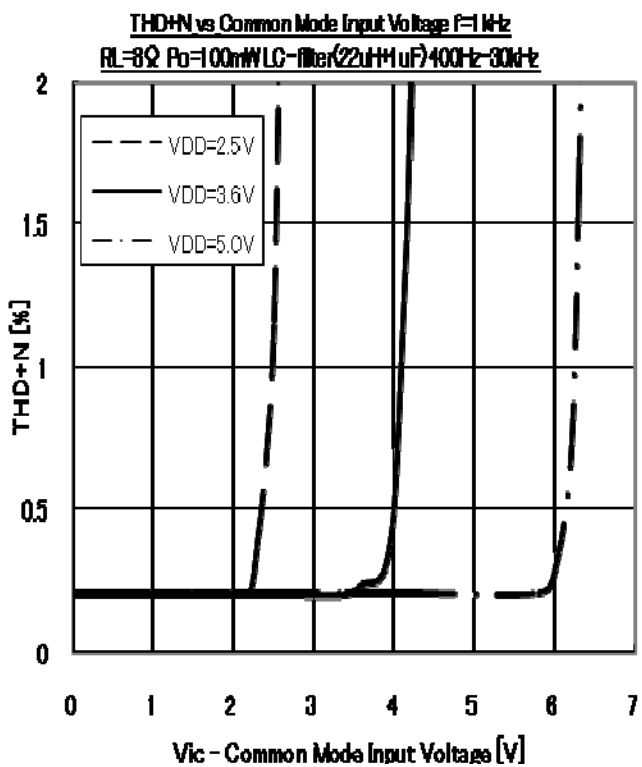

Figure.26

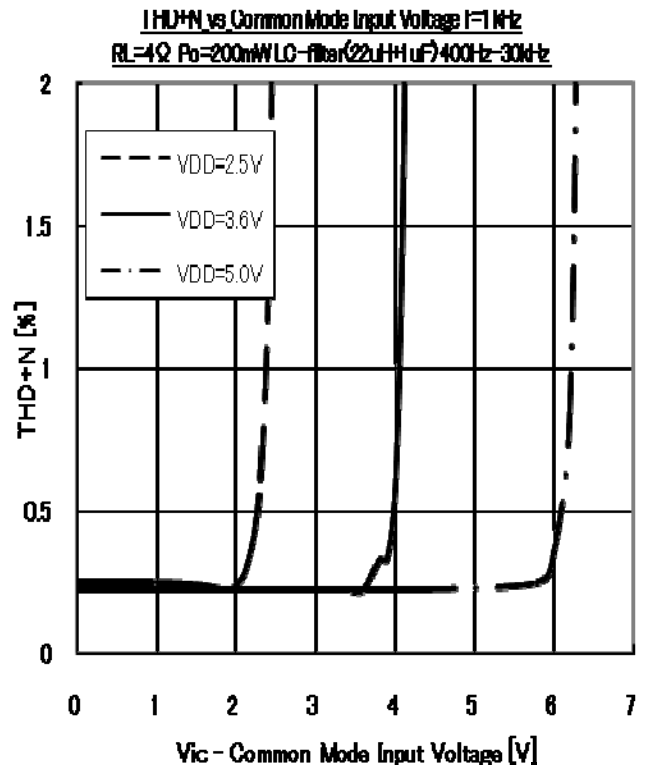

Figure.27

Typical Performance Curves - continued

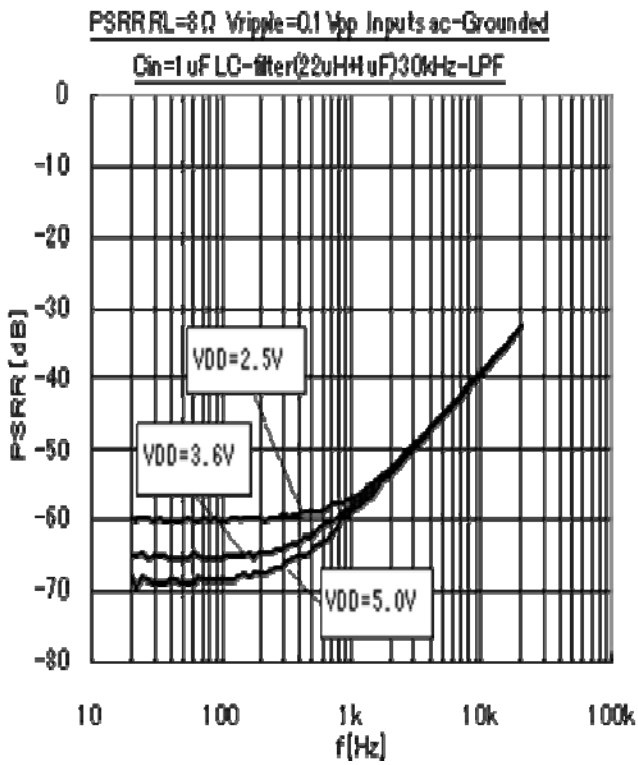

Figure.28

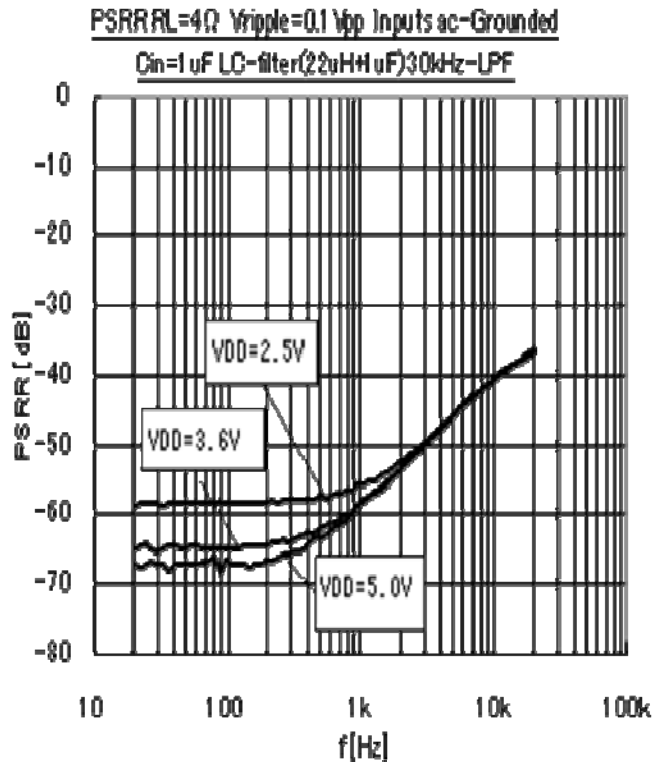

Figure.29

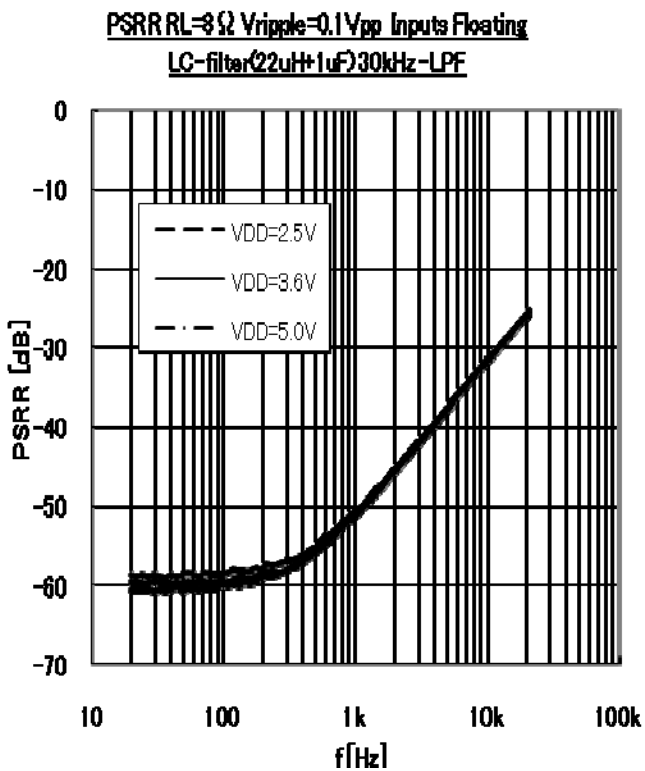

Figure.30

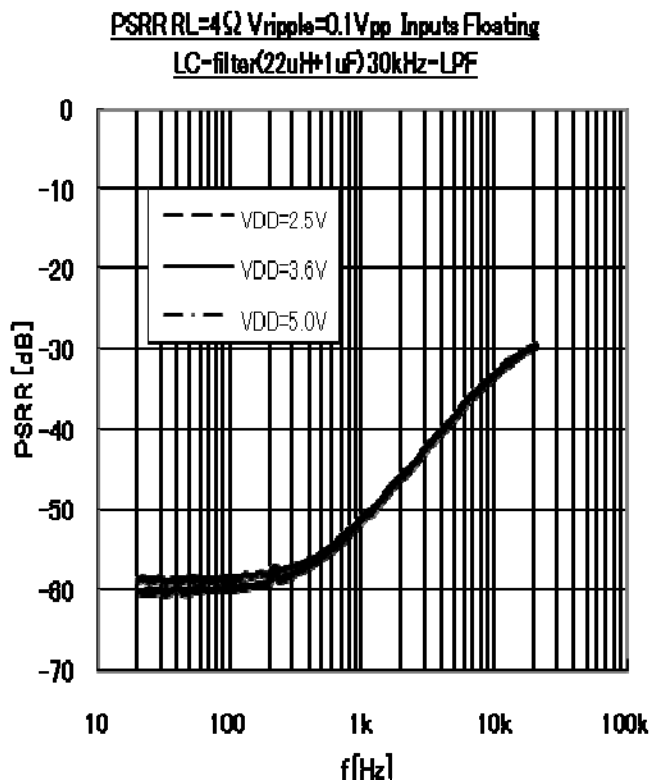

Figure.31

Typical Performance Curves - continued

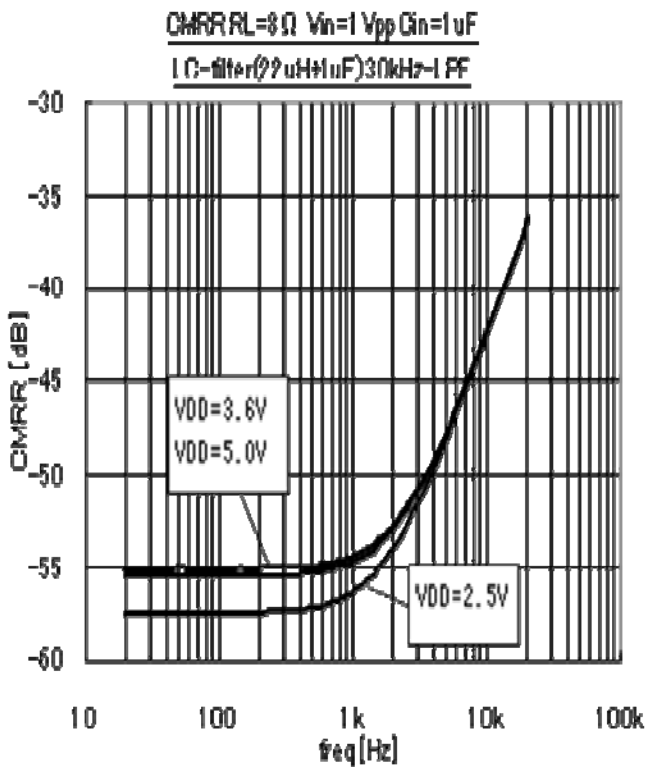

Figure.32

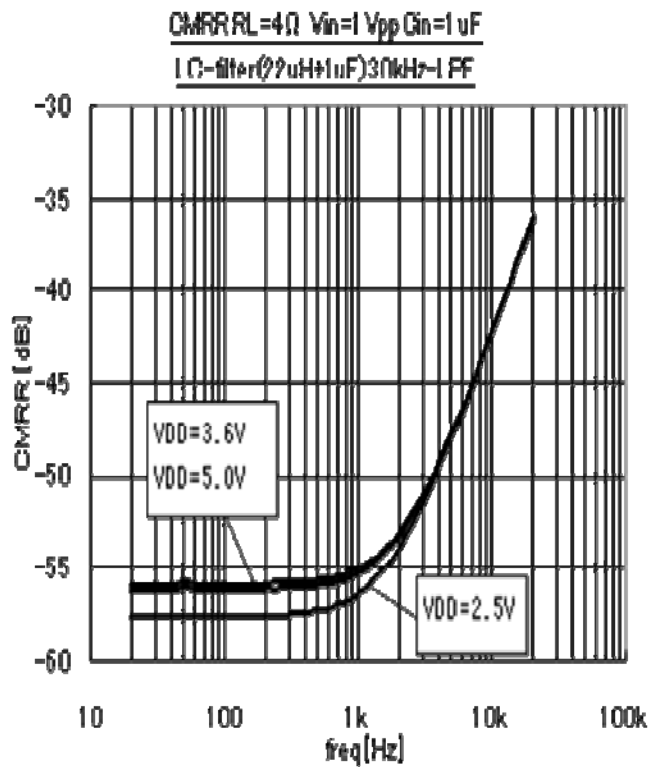

Figure.33

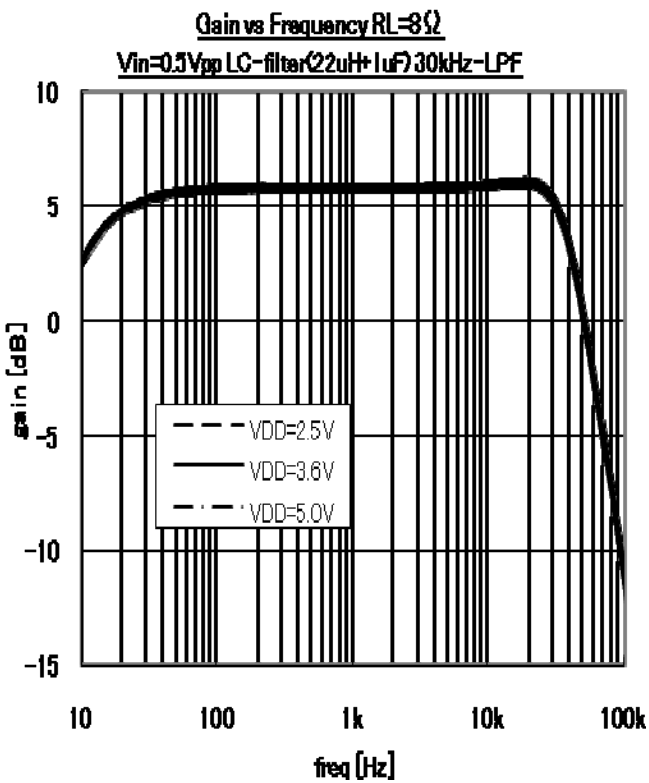

Figure.34

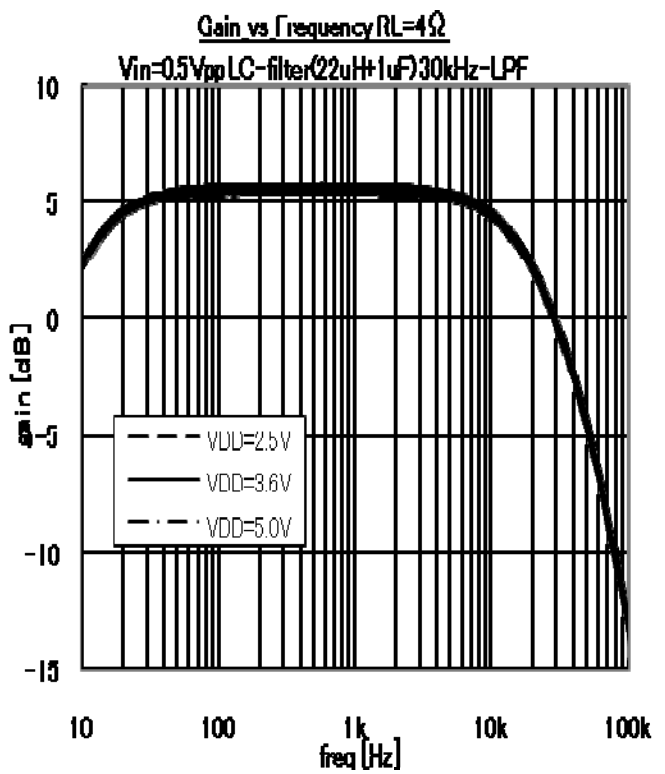

Figure.35

Application Example(s)

Connect VDD(B1) and PVDD(B2) on PCB board, and use a single power supply.

(1)Differential input

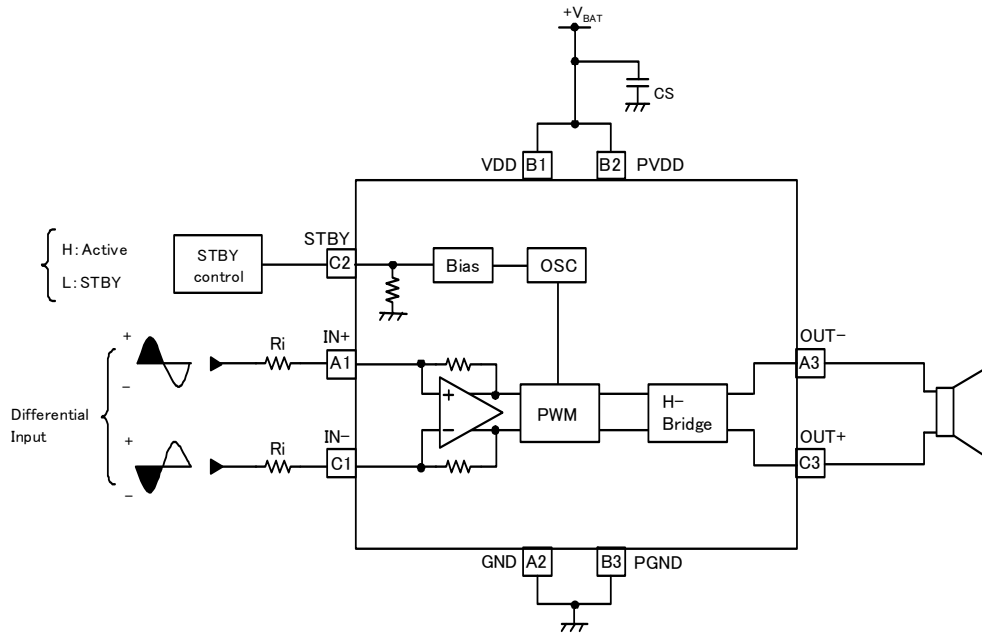

Figure.36 Differential input for mobile phone

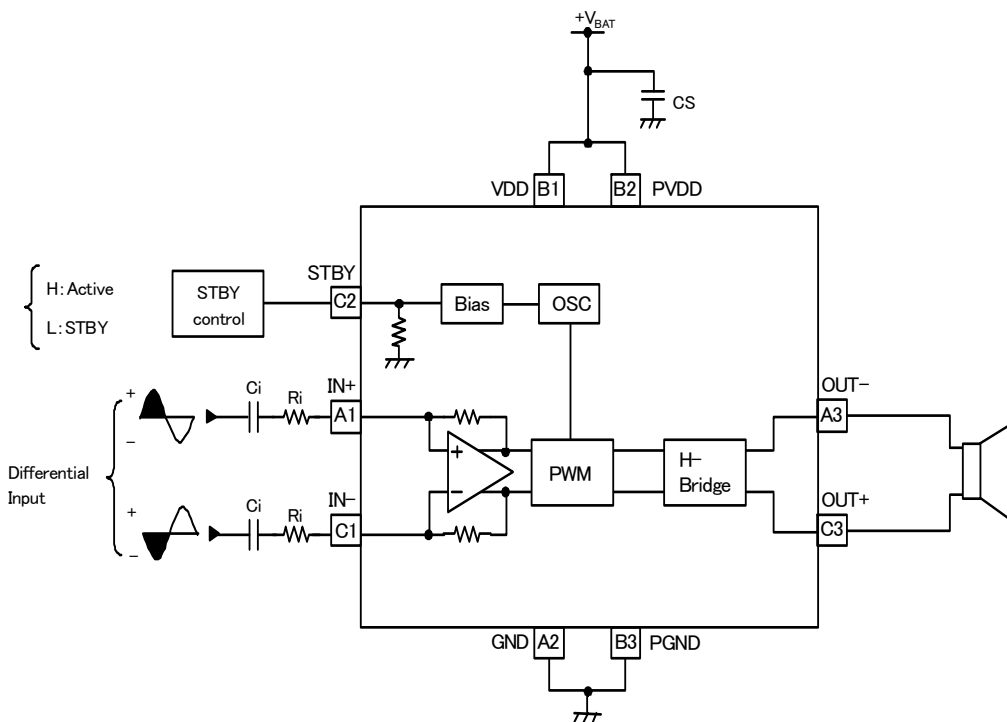

Figure.37 Differential input with coupling input capacitors

(2)Single-Ended input

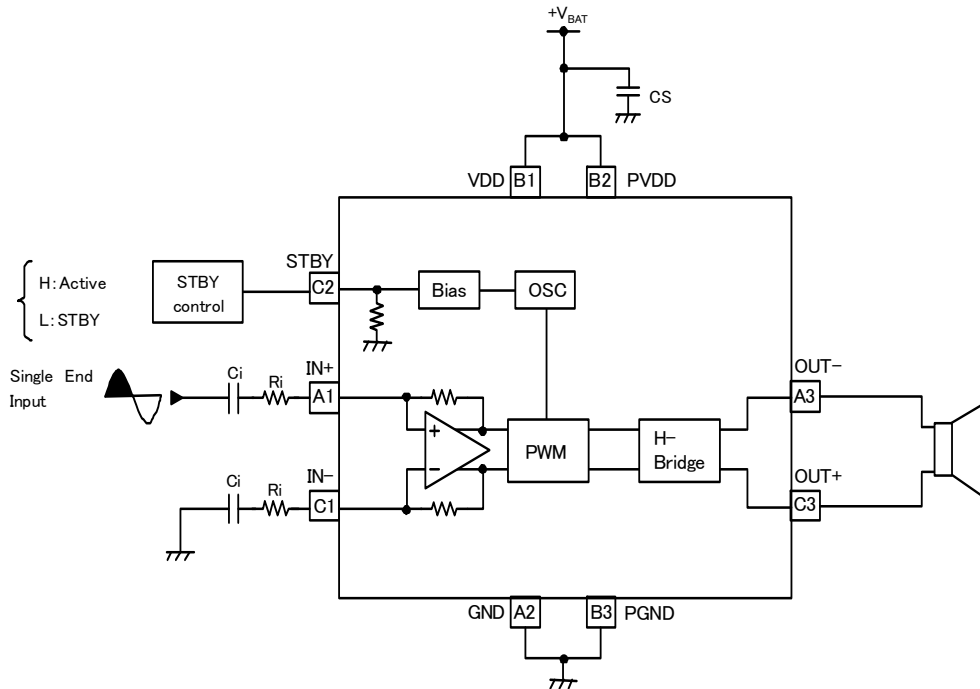

Figure.38 Single-Ended input

- It is possible to input audio signal from IN+ terminal, or IN- terminal when single-end mode.
- Don't make the input terminal (no input terminal, C1 terminal in above figure) open.
Pop noise may be caused when the power supply starts up or the standby is released, if input terminal is opened.
- Connect non signal input side(C1 in above figure)to GND through Ci, and make the value of Ri, Ci of non signal input side same as the value of signal input side (A1 in above figure).
Pop noise may be caused if each values of Ci, Ri are different, because the values of Ci, Ri decide the rise of Input terminal DC voltage when start-up. Difference of input terminal DC voltages may make pop noise.
- Make the value of Ri, Ci of non signal input side same as the value of signal input side when making LPF(Low Pass Filter) at previous stage of Ci.
- Put external input resistor Ri as close as possible to this IC.

Selection of Components Externally Connected

• Description of External components

① Input coupling capacitor (Ci) and input resistor (Ri).

It makes an Input coupling capacitor 0.1uF. Input impedance is 150kΩ.

It sets cutoff frequency f_c by the following formula by input coupling capacitor Ci and input impedance Ri.

$$f_c = \frac{1}{2\pi \times R_i \times C_i} \text{ [Hz]}$$

In case of $R_i=150k\Omega$, $C_i=0.1\mu F$, it becomes $f_c =$ about 10 Hz.

② Power decoupling capacitor (CS)

It makes a power decoupling capacitor 10 μF.

When making capacitance of the power decoupling capacitor, there is an influence in the Audio characteristic.

When making small, careful for the Audio characteristic at the actual application.

Power Dissipation

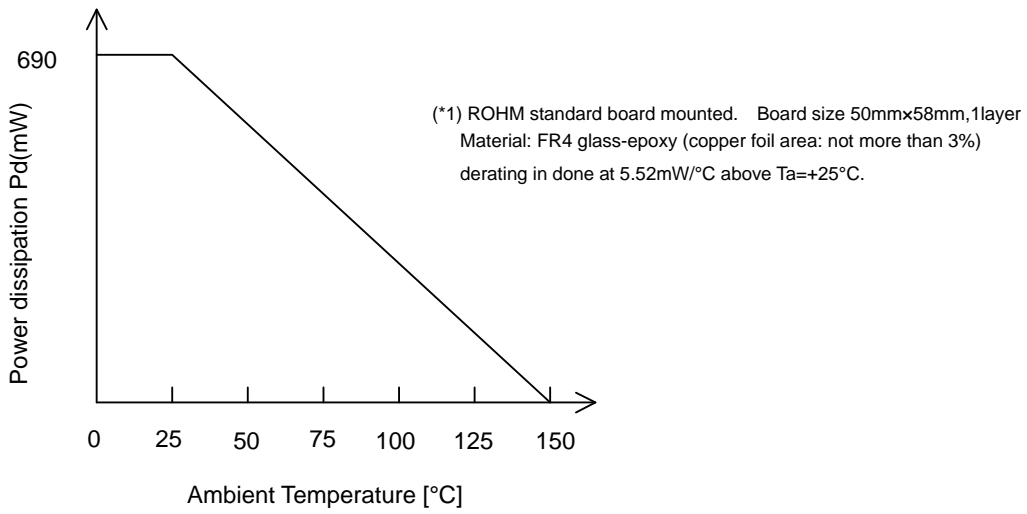

I/O equivalence circuits

Pin name	Pin No.	
IN+ IN-	A1 C1	
OUT+ OUT-	C3 A3	
STBY	C2	

Operational Notes

1. Reverse Connection of Power Supply

Connecting the power supply in reverse polarity can damage the IC. Take precautions against reverse polarity when connecting the power supply, such as mounting an external diode between the power supply and the IC's power supply pins.

2. Power Supply Lines

Design the PCB layout pattern to provide low impedance supply lines. Separate the ground and supply lines of the digital and analog blocks to prevent noise in the ground and supply lines of the digital block from affecting the analog block. Furthermore, connect a capacitor to ground at all power supply pins. Consider the effect of temperature and aging on the capacitance value when using electrolytic capacitors.

3. Ground Voltage

Ensure that no pins are at a voltage below that of the ground pin at any time, even during transient condition.

4. Ground Wiring Pattern

When using both small-signal and large-current ground traces, the two ground traces should be routed separately but connected to a single ground at the reference point of the application board to avoid fluctuations in the small-signal ground caused by large currents. Also ensure that the ground traces of external components do not cause variations on the ground voltage. The ground lines must be as short and thick as possible to reduce line impedance.

5. Thermal Consideration

Should by any chance the power dissipation rating be exceeded the rise in temperature of the chip may result in deterioration of the properties of the chip. The absolute maximum rating of the Pd stated in this specification is when the IC is mounted on a 50mm×58mm glass epoxy board. In case of exceeding this absolute maximum rating, increase the board size and copper area to prevent exceeding the Pd rating.

6. Recommended Operating Conditions

These conditions represent a range within which the expected characteristics of the IC can be approximately obtained. The electrical characteristics are guaranteed under the conditions of each parameter.

7. Inrush Current

When power is first supplied to the IC, it is possible that the internal logic may be unstable and inrush current may flow instantaneously due to the internal powering sequence and delays, especially if the IC has more than one power supply. Therefore, give special consideration to power coupling capacitance, power wiring, width of ground wiring, and routing of connections.

8. Operation Under Strong Electromagnetic Field

Operating the IC in the presence of a strong electromagnetic field may cause the IC to malfunction.

9. Testing on Application Boards

When testing the IC on an application board, connecting a capacitor directly to a low-impedance output pin may subject the IC to stress. Always discharge capacitors completely after each process or step. The IC's power supply should always be turned off completely before connecting or removing it from the test setup during the inspection process. To prevent damage from static discharge, ground the IC during assembly and use similar precautions during transport and storage.

10. Inter-pin Short and Mounting Errors

Ensure that the direction and position are correct when mounting the IC on the PCB. Incorrect mounting may result in damaging the IC. Avoid nearby pins being shorted to each other especially to ground, power supply and output pin. Inter-pin shorts could be due to many reasons such as metal particles, water droplets (in very humid environment) and unintentional solder bridge deposited in between pins during assembly to name a few.

Operational Notes – continued

11. Unused Input Pins

Input pins of an IC are often connected to the gate of a MOS transistor. The gate has extremely high impedance and extremely low capacitance. If left unconnected, the electric field from the outside can easily charge it. The small charge acquired in this way is enough to produce a significant effect on the conduction through the transistor and cause unexpected operation of the IC. So unless otherwise specified, unused input pins should be connected to the power supply or ground line.

12. Regarding the Input Pin of the IC

This monolithic IC contains P+ isolation and P substrate layers between adjacent elements in order to keep them isolated. P-N junctions are formed at the intersection of the P layers with the N layers of other elements, creating a parasitic diode or transistor. For example (refer to figure below):

When $GND > Pin A$ and $GND > Pin B$, the P-N junction operates as a parasitic diode.
When $GND > Pin B$, the P-N junction operates as a parasitic transistor.

Parasitic diodes inevitably occur in the structure of the IC. The operation of parasitic diodes can result in mutual interference among circuits, operational faults, or physical damage. Therefore, conditions that cause these diodes to operate, such as applying a voltage lower than the GND voltage to an input pin (and thus to the P substrate) should be avoided.

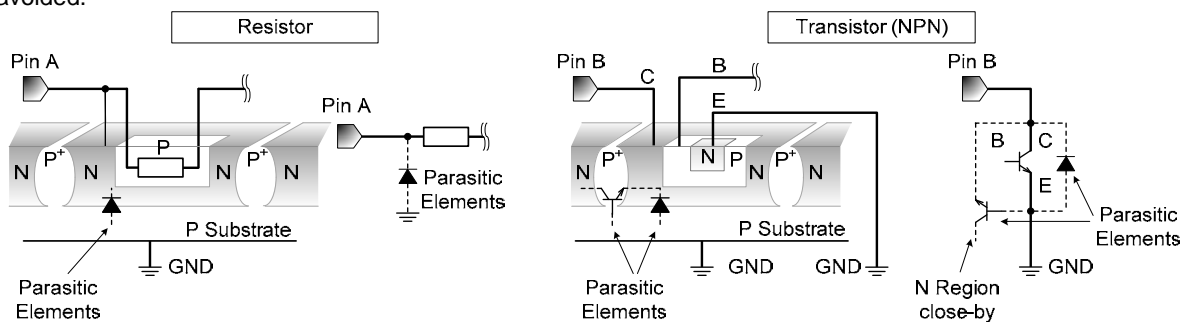

Figure 39. Example of monolithic IC structure

13. Ceramic Capacitor

When using a ceramic capacitor, determine the dielectric constant considering the change of capacitance with temperature and the decrease in nominal capacitance due to DC bias and others.

14. Thermal Shutdown Circuit(TSD)

This IC has a built-in thermal shutdown circuit that prevents heat damage to the IC. Normal operation should always be within the IC's power dissipation rating. If however the rating is exceeded for a continued period, the junction temperature (T_j) will rise which will activate the TSD circuit that will turn OFF all output pins. When the T_j falls below the TSD threshold, the circuits are automatically restored to normal operation.

Note that the TSD circuit operates in a situation that exceeds the absolute maximum ratings and therefore, under no circumstances, should the TSD circuit be used in a set design or for any purpose other than protecting the IC from heat damage.

15. Over Current Protection Circuit (OCP)

This IC incorporates an integrated overcurrent protection circuit that is activated when the load is shorted. This protection circuit is effective in preventing damage due to sudden and unexpected incidents. However, the IC should not be used in applications characterized by continuous operation or transitioning of the protection circuit.

Ordering Information

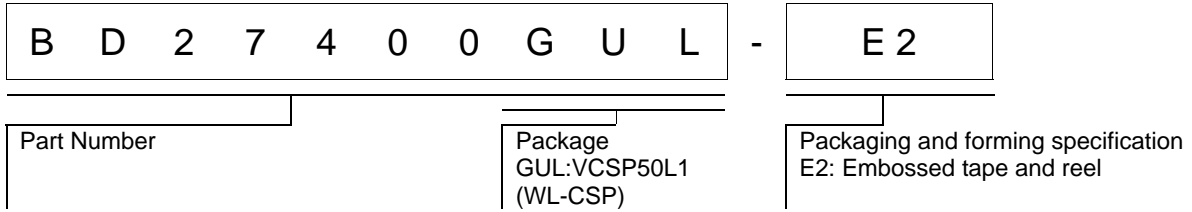

Marking Diagrams

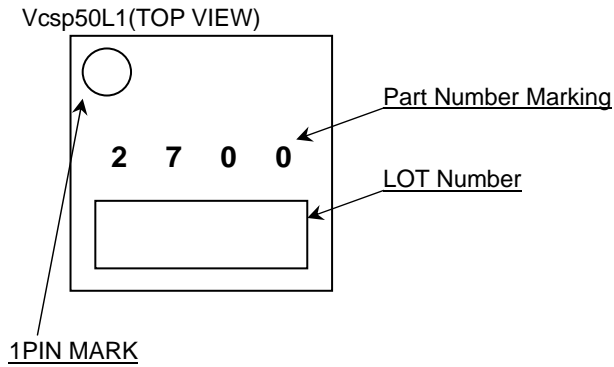

Part Number Marking	Package	Orderable Part Number
2700	VCSP50L1	BD27400GUL-E2

Physical Dimension Tape and Reel Information

Package Name	VCSP50L1(BD27400GUL)
--------------	----------------------

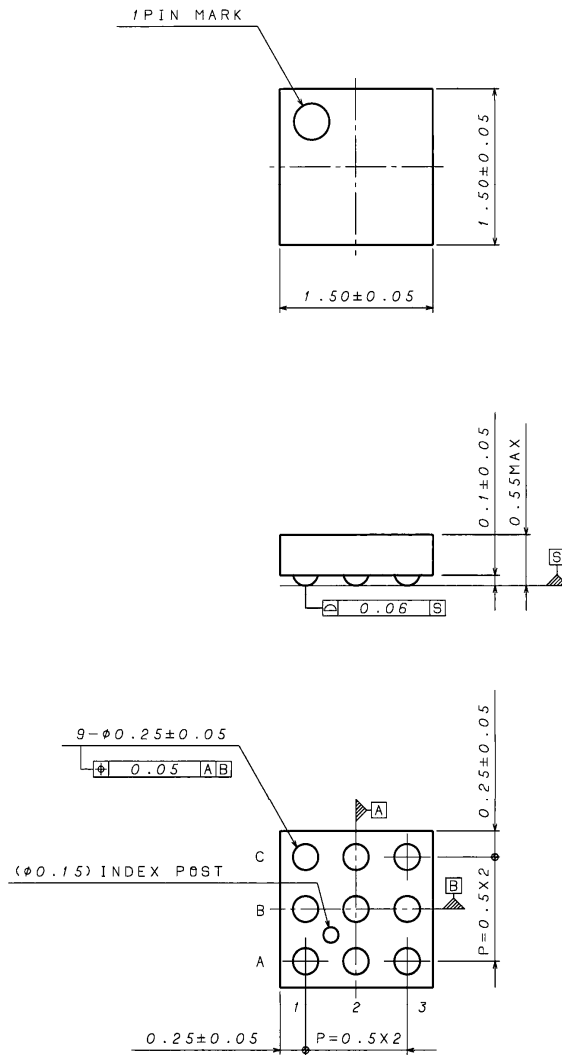

(UNIT : mm)

< Tape and Reel Information >

Tape	Embossed carrier tape
Quantity	3000pcs
Direction of feed	E2 The direction is the pin 1 of product is at the upper left when you hold reel on the left hand and you pull out the tape on the right hand

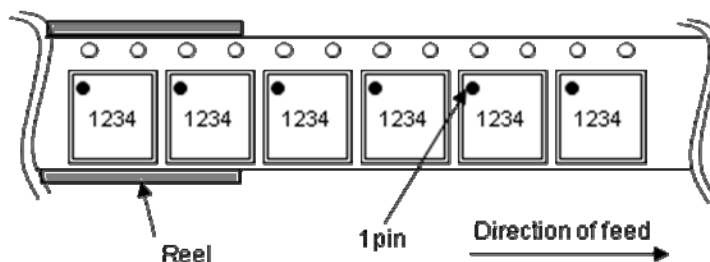

Revision History

Date	Revision	Changes
05.Apr.2012	001	New Release
05.Nov.2012	002	All. Change to a new format
23.Apr.2014	003	p.3. Change unit of a Output Power3 mW -> W Change the value of PSRR 56dB->64dB p.17 Change Part Number Marking p.18 Change to a new format at Physical Dimension Tape and Reel Information

Notice

Precaution on using ROHM Products

- Our Products are designed and manufactured for application in ordinary electronic equipments (such as AV equipment, OA equipment, telecommunication equipment, home electronic appliances, amusement equipment, etc.). If you intend to use our Products in devices requiring extremely high reliability (such as medical equipment ^(Note 1), transport equipment, traffic equipment, aircraft/spacecraft, nuclear power controllers, fuel controllers, car equipment including car accessories, safety devices, etc.) and whose malfunction or failure may cause loss of human life, bodily injury or serious damage to property ("Specific Applications"), please consult with the ROHM sales representative in advance. Unless otherwise agreed in writing by ROHM in advance, ROHM shall not be in any way responsible or liable for any damages, expenses or losses incurred by you or third parties arising from the use of any ROHM's Products for Specific Applications.

(Note1) Medical Equipment Classification of the Specific Applications

JAPAN	USA	EU	CHINA
CLASS III	CLASS III	CLASS II b	CLASS III
CLASS IV		CLASS III	

- ROHM designs and manufactures its Products subject to strict quality control system. However, semiconductor products can fail or malfunction at a certain rate. Please be sure to implement, at your own responsibilities, adequate safety measures including but not limited to fail-safe design against the physical injury, damage to any property, which a failure or malfunction of our Products may cause. The following are examples of safety measures:
 - Installation of protection circuits or other protective devices to improve system safety
 - Installation of redundant circuits to reduce the impact of single or multiple circuit failure
- Our Products are designed and manufactured for use under standard conditions and not under any special or extraordinary environments or conditions, as exemplified below. Accordingly, ROHM shall not be in any way responsible or liable for any damages, expenses or losses arising from the use of any ROHM's Products under any special or extraordinary environments or conditions. If you intend to use our Products under any special or extraordinary environments or conditions (as exemplified below), your independent verification and confirmation of product performance, reliability, etc. prior to use, must be necessary:
 - Use of our Products in any types of liquid, including water, oils, chemicals, and organic solvents
 - Use of our Products outdoors or in places where the Products are exposed to direct sunlight or dust
 - Use of our Products in places where the Products are exposed to sea wind or corrosive gases, including Cl₂, H₂S, NH₃, SO₂, and NO₂
 - Use of our Products in places where the Products are exposed to static electricity or electromagnetic waves
 - Use of our Products in proximity to heat-producing components, plastic cords, or other flammable items
 - Sealing or coating our Products with resin or other coating materials
 - Use of our Products without cleaning residue of flux (even if you use no-clean type fluxes, cleaning residue of flux is recommended); or Washing our Products by using water or water-soluble cleaning agents for cleaning residue after soldering
 - Use of the Products in places subject to dew condensation
- The Products are not subject to radiation-proof design.
- Please verify and confirm characteristics of the final or mounted products in using the Products.
- In particular, if a transient load (a large amount of load applied in a short period of time, such as pulse. is applied, confirmation of performance characteristics after on-board mounting is strongly recommended. Avoid applying power exceeding normal rated power; exceeding the power rating under steady-state loading condition may negatively affect product performance and reliability.
- De-rate Power Dissipation (Pd) depending on Ambient temperature (Ta). When used in sealed area, confirm the actual ambient temperature.
- Confirm that operation temperature is within the specified range described in the product specification.
- ROHM shall not be in any way responsible or liable for failure induced under deviant condition from what is defined in this document.

Precaution for Mounting / Circuit board design

- When a highly active halogenous (chlorine, bromine, etc.) flux is used, the residue of flux may negatively affect product performance and reliability.
- In principle, the reflow soldering method must be used; if flow soldering method is preferred, please consult with the ROHM representative in advance.

For details, please refer to ROHM Mounting specification

Precautions Regarding Application Examples and External Circuits

1. If change is made to the constant of an external circuit, please allow a sufficient margin considering variations of the characteristics of the Products and external components, including transient characteristics, as well as static characteristics.
2. You agree that application notes, reference designs, and associated data and information contained in this document are presented only as guidance for Products use. Therefore, in case you use such information, you are solely responsible for it and you must exercise your own independent verification and judgment in the use of such information contained in this document. ROHM shall not be in any way responsible or liable for any damages, expenses or losses incurred by you or third parties arising from the use of such information.

Precaution for Electrostatic

This Product is electrostatic sensitive product, which may be damaged due to electrostatic discharge. Please take proper caution in your manufacturing process and storage so that voltage exceeding the Products maximum rating will not be applied to Products. Please take special care under dry condition (e.g. Grounding of human body / equipment / solder iron, isolation from charged objects, setting of Ionizer, friction prevention and temperature / humidity control).

Precaution for Storage / Transportation

1. Product performance and soldered connections may deteriorate if the Products are stored in the places where:
 - [a] the Products are exposed to sea winds or corrosive gases, including Cl₂, H₂S, NH₃, SO₂, and NO₂
 - [b] the temperature or humidity exceeds those recommended by ROHM
 - [c] the Products are exposed to direct sunshine or condensation
 - [d] the Products are exposed to high Electrostatic
2. Even under ROHM recommended storage condition, solderability of products out of recommended storage time period may be degraded. It is strongly recommended to confirm solderability before using Products of which storage time is exceeding the recommended storage time period.
3. Store / transport cartons in the correct direction, which is indicated on a carton with a symbol. Otherwise bent leads may occur due to excessive stress applied when dropping of a carton.
4. Use Products within the specified time after opening a humidity barrier bag. Baking is required before using Products of which storage time is exceeding the recommended storage time period.

Precaution for Product Label

QR code printed on ROHM Products label is for ROHM's internal use only.

Precaution for Disposition

When disposing Products please dispose them properly using an authorized industry waste company.

Precaution for Foreign Exchange and Foreign Trade act

Since our Products might fall under controlled goods prescribed by the applicable foreign exchange and foreign trade act, please consult with ROHM representative in case of export.

Precaution Regarding Intellectual Property Rights

1. All information and data including but not limited to application example contained in this document is for reference only. ROHM does not warrant that foregoing information or data will not infringe any intellectual property rights or any other rights of any third party regarding such information or data. ROHM shall not be in any way responsible or liable for infringement of any intellectual property rights or other damages arising from use of such information or data.:
2. No license, expressly or implied, is granted hereby under any intellectual property rights or other rights of ROHM or any third parties with respect to the information contained in this document.

Other Precaution

1. This document may not be reprinted or reproduced, in whole or in part, without prior written consent of ROHM.
2. The Products may not be disassembled, converted, modified, reproduced or otherwise changed without prior written consent of ROHM.
3. In no event shall you use in any way whatsoever the Products and the related technical information contained in the Products or this document for any military purposes, including but not limited to, the development of mass-destruction weapons.
4. The proper names of companies or products described in this document are trademarks or registered trademarks of ROHM, its affiliated companies or third parties.

General Precaution

1. Before you use our Products, you are requested to carefully read this document and fully understand its contents. ROHM shall not be in any way responsible or liable for failure, malfunction or accident arising from the use of any ROHM's Products against warning, caution or note contained in this document.
2. All information contained in this document is current as of the issuing date and subject to change without any prior notice. Before purchasing or using ROHM's Products, please confirm the latest information with a ROHM sales representative.
3. The information contained in this document is provided on an "as is" basis and ROHM does not warrant that all information contained in this document is accurate and/or error-free. ROHM shall not be in any way responsible or liable for any damages, expenses or losses incurred by you or third parties resulting from inaccuracy or errors of or concerning such information.

Данный компонент на территории Российской Федерации

Вы можете приобрести в компании MosChip.

Для оперативного оформления запроса Вам необходимо перейти по данной ссылке:

<http://moschip.ru/get-element>

Вы можете разместить у нас заказ для любого Вашего проекта, будь то серийное производство или разработка единичного прибора.

В нашем ассортименте представлены ведущие мировые производители активных и пассивных электронных компонентов.

Нашей специализацией является поставка электронной компонентной базы двойного назначения, продукции таких производителей как XILINX, Intel (ex.ALTERA), Vicor, Microchip, Texas Instruments, Analog Devices, Mini-Circuits, Amphenol, Glenair.

Сотрудничество с глобальными дистрибьюторами электронных компонентов, предоставляет возможность заказывать и получать с международных складов практически любой перечень компонентов в оптимальные для Вас сроки.

На всех этапах разработки и производства наши партнеры могут получить квалифицированную поддержку опытных инженеров.

Система менеджмента качества компании отвечает требованиям в соответствии с ГОСТ Р ИСО 9001, ГОСТ РВ 0015-002 и ЭС РД 009

Офис по работе с юридическими лицами:

105318, г.Москва, ул.Щербаковская д.3, офис 1107, 1118, ДЦ «Щербаковский»

Телефон: +7 495 668-12-70 (многоканальный)

Факс: +7 495 668-12-70 (доб.304)

E-mail: info@moschip.ru

Skype отдела продаж:

moschip.ru

moschip.ru_4

moschip.ru_6

moschip.ru_9