

## FEATURES

- Dual-channel, 1024-position resolution**
- 25 k $\Omega$ , 250 k $\Omega$  nominal resistance**
- Maximum  $\pm 8\%$  nominal resistor tolerance error**
- Low temperature coefficient: 35 ppm/ $^{\circ}\text{C}$**
- 2.7 V to 5 V single supply or  $\pm 2.5$  V dual supply**
- SPI-compatible serial interface**
- Nonvolatile memory stores wiper settings**
- Power-on refreshed with EEMEM settings**
- Permanent memory write protection**
- Resistance tolerance stored in EEMEM**
- 26 bytes extra nonvolatile memory for user-defined information**
- 1M programming cycles**
- 100-year typical data retention**

## APPLICATIONS

- DWDM laser diode driver, optical supervisory systems**
- Mechanical potentiometer replacement**
- Instrumentation: gain, offset adjustment**
- Programmable voltage-to-current conversion**
- Programmable filters, delays, time constants**
- Programmable power supply**
- Low resolution DAC replacement**
- Sensor calibration**

## GENERAL DESCRIPTION

The AD5235 is a dual-channel, nonvolatile memory,<sup>1</sup> digitally controlled potentiometer<sup>2</sup> with 1024-step resolution, offering guaranteed maximum low resistor tolerance error of  $\pm 8\%$ . The device performs the same electronic adjustment function as a mechanical potentiometer with enhanced resolution, solid state reliability, and superior low temperature coefficient performance. The versatile programming of the AD5235 via an SPI<sup>®</sup>-compatible serial interface allows 16 modes of operation and adjustment including scratchpad programming, memory storing and restoring, increment/decrement,  $\pm 6$  dB/step log taper adjustment, wiper setting readback, and extra EEMEM<sup>1</sup> for user-defined information such as memory data for other components, look-up table, or system identification information.

<sup>1</sup> The terms nonvolatile memory and EEMEM are used interchangeably.

<sup>2</sup> The terms digital potentiometer and RDAC are used interchangeably.

## FUNCTIONAL BLOCK DIAGRAM

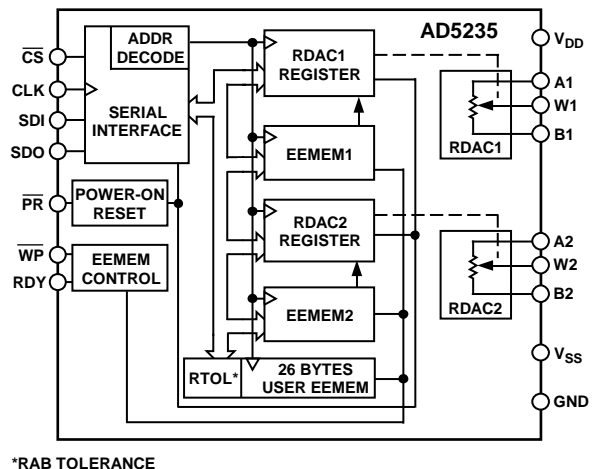

Figure 1.

In the scratchpad programming mode, a specific setting can be programmed directly to the RDAC<sup>2</sup> register, which sets the resistance between Terminal W and Terminal A and Terminal W and Terminal B. This setting can be stored into the EEMEM and is restored automatically to the RDAC register during system power-on.

The EEMEM content can be restored dynamically or through external  $\overline{\text{PR}}$  strobing, and a  $\overline{\text{WP}}$  function protects EEMEM contents. To simplify the programming, the independent or simultaneous linear-step increment or decrement commands can be used to move the RDAC wiper up or down, one step at a time. For logarithmic  $\pm 6$  dB changes in the wiper setting, the left or right bit shift command can be used to double or halve the RDAC wiper setting.

The AD5235 patterned resistance tolerance is stored in the EEMEM. The actual end-to-end resistance can, therefore, be known by the host processor in readback mode. The host can execute the appropriate resistance step through a software routine that simplifies open-loop applications as well as precision calibration and tolerance matching applications.

The AD5235 is available in a thin, 16-lead TSSOP package. The part is guaranteed to operate over the extended industrial temperature range of  $-40^{\circ}\text{C}$  to  $+85^{\circ}\text{C}$ .

## Rev. F

Information furnished by Analog Devices is believed to be accurate and reliable. However, no responsibility is assumed by Analog Devices for its use, nor for any infringements of patents or other rights of third parties that may result from its use. Specifications subject to change without notice. No license is granted by implication or otherwise under any patent or patent rights of Analog Devices. Trademarks and registered trademarks are the property of their respective owners.

## TABLE OF CONTENTS

Features .....	1	Programming the Variable Resistor .....	22
Applications .....	1	Programming the Potentiometer Divider .....	22
General Description .....	1	Programming Examples .....	23
Functional Block Diagram .....	1	EVAL-AD5235SDZ Evaluation Kit .....	23
Revision History .....	3	Applications Information .....	24
Specifications .....	4	Bipolar Operation from Dual Supplies .....	24
Electrical Characteristics—25 k $\Omega$ , 250 k $\Omega$ Versions .....	4	Gain Control Compensation .....	24
Interface Timing and EEMEM Reliability Characteristics—		High Voltage Operation .....	24
25 k $\Omega$ , 250 k $\Omega$ Versions .....	6	DAC .....	24
Absolute Maximum Ratings .....	8	Bipolar Programmable Gain Amplifier .....	25
ESD Caution .....	8	10-Bit Bipolar DAC .....	25
Pin Configuration and Function Descriptions .....	9	Programmable Voltage Source with Boosted Output .....	25
Typical Performance Characteristics .....	10	Programmable Current Source .....	26
Test Circuits .....	14	Programmable Bidirectional Current Source .....	26
Theory of Operation .....	16	Programmable Low-Pass Filter .....	27
Scratchpad and EEMEM Programming .....	16	Programmable Oscillator .....	27
Basic Operation .....	16	Optical Transmitter Calibration with ADN2841 .....	28
EEMEM Protection .....	17	Resistance Scaling .....	28
Digital Input and Output Configuration .....	17	Resistance Tolerance, Drift, and Temperature Coefficient	
Serial Data Interface .....	17	Mismatch Considerations .....	29
Daisy-Chain Operation .....	18	RDAC Circuit Simulation Model .....	29
Terminal Voltage Operating Range .....	18	Outline Dimensions .....	30
Advanced Control Modes .....	20	Ordering Guide .....	30
RDAC Structure .....	21		

**REVISION HISTORY****6/12—Rev. E to Rev. F**

Changes to Table 1 Conditions.....	4
Removed Positive Supply Current RDY and/or SDO Floating Parameters and Negative Supply Current RDY and/or SDO Floating Parameters, Table 1.....	5
Added Endnote 2 to Ordering Guide.....	30

**4/11—Rev. D to Rev. E**

Changes to Figure 12.....	11
---------------------------	----

**4/11—Rev. C to Rev. D**

Changes to EEMEM Performance.....	Throughout
Changes to Features and General Descriptions Sections.....	1
Changes to Specifications Section.....	4
Changes to Pin 5, Pin 13, Pin 14 Descriptions.....	9
Changes to Typical Performance Characteristics Section.....	10
Changes to Table 7.....	19
Changes to Table 9.....	21
Changes to Rheostat Operation Section, Table 12, Table 13.....	22
Changes to Table 16, Table 19, and EVAL-AD5235SDZ Evaluation Kit Section.....	23
Changes to RDAC Circuit Simulation Model Section.....	29
Updated Outline Dimensions.....	30
Changes to Ordering Guide.....	30

**4/09—Rev. B to Rev. C**

Changes to Figure 1.....	1
Changes to Specifications.....	3
Changes to SDO, Description Column, Table 4.....	8
Changes to Figure 18.....	11
Changes to Theory of Operation Section.....	14
Changes to Serial Data Interface Section.....	15
Changes to Linear Increment and Decrement Instructions Section, Logarithmic Taper Mode Adjustment Section, and Figure 42.....	18
Changes to Rheostat Operations Section.....	20
Changes to Bipolar Programmable Gain Amplifier Section, Figure 49, Table 21, and 10-Bit Bipolar DAC Section.....	23
Changes to Programmable Oscillator Section and Figure 56.....	25
Changes to Ordering Guide.....	28

**7/04—Rev. A to Rev. B**

Updated Formatting.....	Universal
Edits to Features, General Description, and Block Diagram.....	1
Changes to Specifications.....	3
Replaced Timing Diagrams.....	6
Changes to Absolute Maximum Ratings.....	7
Changes to Pin Function Descriptions.....	8
Changes to Typical Performance Characteristics.....	9
Additional Test Circuit (Figure 36).....	9
Edits to Theory of Operation.....	14
Edits to Applications.....	23
Updated Outline Dimensions.....	27

**8/02—Rev. 0 to Rev. A**

Change to Features and General Description.....	1
Change to Specifications.....	2
Change to Calculating Actual End-to-End Terminal Resistance Section.....	14

## SPECIFICATIONS

ELECTRICAL CHARACTERISTICS—25 k $\Omega$ , 250 k $\Omega$  VERSIONS

$V_{DD} = 2.7\text{ V to } 5.5\text{ V}$ ,  $V_{SS} = 0\text{ V}$ ;  $V_{DD} = 2.5\text{ V}$ ,  $V_{SS} = -2.5\text{ V}$ ,  $V_A = V_{DD}$ ,  $V_B = V_{SS}$ ,  $-40^\circ\text{C} < T_A < +85^\circ\text{C}$ , unless otherwise noted.

These specifications apply to versions with a date code 1209 or later.

Table 1.

Parameter	Symbol	Conditions	Min	Typ <sup>1</sup>	Max	Unit
DC CHARACTERISTICS—RHEOSTAT MODE (All RDACs)						
Resistor Differential Nonlinearity <sup>2</sup>	R-DNL	$R_{WB}$	-1		+1	LSB
Resistor Integral Nonlinearity <sup>2</sup>	R-INL	$R_{WB}$	-2		+2	LSB
Nominal Resistor Tolerance	$\Delta R_{AB}/R_{AB}$		-8		+8	%
Resistance Temperature Coefficient	$(\Delta R_{AB}/R_{AB})/\Delta T \times 10^6$			35		ppm/ $^\circ\text{C}$
Wiper Resistance	$R_W$	$I_W = 1\text{ V}/R_{WB}$ , code = midscale $V_{DD} = 5\text{ V}$ $V_{DD} = 3\text{ V}$		30	60	$\Omega$
Nominal Resistance Match	$R_{AB1}/R_{AB2}$			50		$\Omega$
				$\pm 0.1$		%
DC CHARACTERISTICS—POTENTIOMETER DIVIDER MODE (All RDACs)						
Resolution	N				10	Bits
Differential Nonlinearity <sup>3</sup>	DNL		-1		+1	LSB
Integral Nonlinearity <sup>3</sup>	INL		-1		+1	LSB
Voltage Divider Temperature Coefficient	$(\Delta V_W/V_W)/\Delta T \times 10^6$	Code = midscale		15		ppm/ $^\circ\text{C}$
Full-Scale Error	$V_{WFSE}$	Code = full scale	-6		0	LSB
Zero-Scale Error	$V_{WZSE}$	Code = zero scale	0		4	LSB
RESISTOR TERMINALS						
Terminal Voltage Range <sup>4</sup>	$V_A, V_B, V_W$		$V_{SS}$		$V_{DD}$	V
Capacitance Ax, Bx <sup>5</sup>	$C_A, C_B$	$f = 1\text{ MHz}$ , measured to GND, code = midscale		11		pF
Capacitance Wx <sup>5</sup>	$C_W$	$f = 1\text{ MHz}$ , measured to GND, code = midscale		80		pF
Common-Mode Leakage Current <sup>5, 6</sup>	$I_{CM}$	$V_W = V_{DD}/2$		0.01	$\pm 1$	$\mu\text{A}$
DIGITAL INPUTS AND OUTPUTS						
Input Logic High	$V_{IH}$	With respect to GND, $V_{DD} = 5\text{ V}$	2.4			V
Input Logic Low	$V_{IL}$	With respect to GND, $V_{DD} = 5\text{ V}$			0.8	V
Input Logic High	$V_{IH}$	With respect to GND, $V_{DD} = 3\text{ V}$	2.1			V
Input Logic Low	$V_{IL}$	With respect to GND, $V_{DD} = 3\text{ V}$			0.6	V
Input Logic High	$V_{IH}$	With respect to GND, $V_{DD} = +2.5\text{ V}$ , $V_{SS} = -2.5\text{ V}$	2.0			V
Input Logic Low	$V_{IL}$	With respect to GND, $V_{DD} = +2.5\text{ V}$ , $V_{SS} = -2.5\text{ V}$			0.5	V
Output Logic High (SDO, RDY)	$V_{OH}$	$R_{PULL-UP} = 2.2\text{ k}\Omega$ to 5 V (see Figure 38)	4.9			V
Output Logic Low	$V_{OL}$	$I_{OL} = 1.6\text{ mA}$ , $V_{LOGIC} = 5\text{ V}$ (see Figure 38)			0.4	V
Input Current	$I_{IL}$	$V_{IN} = 0\text{ V or } V_{DD}$			$\pm 1$	$\mu\text{A}$
Input Capacitance <sup>5</sup>	$C_{IL}$			5		pF

Parameter	Symbol	Conditions	Min	Typ <sup>1</sup>	Max	Unit
<b>POWER SUPPLIES</b>						
Single-Supply Power Range	V <sub>DD</sub>	V <sub>SS</sub> = 0 V	2.7		5.5	V
Dual-Supply Power Range	V <sub>DD</sub> /V <sub>SS</sub>		±2.25		±2.75	V
Positive Supply Current	I <sub>DD</sub>	V <sub>IH</sub> = V <sub>DD</sub> or V <sub>IL</sub> = GND		2	5	μA
Negative Supply Current	I <sub>SS</sub>	V <sub>DD</sub> = +2.5 V, V <sub>SS</sub> = -2.5 V V <sub>IH</sub> = V <sub>DD</sub> or V <sub>IL</sub> = GND	-4	-2		μA
EEMEM Store Mode Current	I <sub>DD</sub> (store)	V <sub>IH</sub> = V <sub>DD</sub> or V <sub>IL</sub> = GND, V <sub>SS</sub> = GND, I <sub>SS</sub> ≈ 0		2		mA
	I <sub>SS</sub> (store)	V <sub>DD</sub> = +2.5 V, V <sub>SS</sub> = -2.5 V		-2		mA
EEMEM Restore Mode Current <sup>7</sup>	I <sub>DD</sub> (restore)	V <sub>IH</sub> = V <sub>DD</sub> or V <sub>IL</sub> = GND, V <sub>SS</sub> = GND, I <sub>SS</sub> ≈ 0		320		μA
	I <sub>SS</sub> (restore)	V <sub>DD</sub> = +2.5 V, V <sub>SS</sub> = -2.5 V		-320		μA
Power Dissipation <sup>8</sup>	P <sub>DISS</sub>	V <sub>IH</sub> = V <sub>DD</sub> or V <sub>IL</sub> = GND		10	30	μW
Power Supply Sensitivity <sup>5</sup>	P <sub>SS</sub>	ΔV <sub>DD</sub> = 5 V ± 10%		0.006	0.01	%/%
<b>DYNAMIC CHARACTERISTICS<sup>5, 9</sup></b>						
Bandwidth	BW	-3 dB, R <sub>AB</sub> = 25 kΩ/250 kΩ		125/12		kHz
Total Harmonic Distortion	THD <sub>W</sub>	V <sub>A</sub> = 1 V rms, V <sub>B</sub> = 0 V, f = 1 kHz, code = midscale R <sub>AB</sub> = 25 kΩ R <sub>AB</sub> = 250 kΩ		0.009 0.035		% %
V <sub>W</sub> Settling Time	t <sub>s</sub>	V <sub>A</sub> = V <sub>DD</sub> , V <sub>B</sub> = 0 V, V <sub>W</sub> = 0.50% error band, from zero scale to midscale R <sub>AB</sub> = 25 kΩ R <sub>AB</sub> = 250 kΩ		4 36		μs μs
Resistor Noise Density	e <sub>N, WB</sub>	R <sub>AB</sub> = 25 kΩ/250 kΩ		20/64		nV/√Hz
Crosstalk (C <sub>W1</sub> /C <sub>W2</sub> )	C <sub>T</sub>	V <sub>A1</sub> = V <sub>DD</sub> , V <sub>B1</sub> = V <sub>SS</sub> , measured V <sub>W2</sub> with V <sub>W1</sub> making full-scale change, R <sub>AB</sub> = 25 kΩ/250 kΩ		30/60		nV-s
Analog Crosstalk	C <sub>TA</sub>	V <sub>AB2</sub> = 5 V p-p, f = 1 kHz, measured V <sub>W1</sub> , Code 1 = midscale, Code 2 = full scale, R <sub>AB</sub> = 25 kΩ/250 kΩ		-110/-100		dB

<sup>1</sup> Typicals represent average readings at 25°C and V<sub>DD</sub> = 5 V.

<sup>2</sup> Resistor position nonlinearity error (R-INL) is the deviation from an ideal value measured between the maximum resistance and the minimum resistance wiper positions. R-DNL measures the relative step change from ideal between successive tap positions. I<sub>WB</sub> = (V<sub>DD</sub> - 1)/R<sub>WB</sub> (see Figure 27).

<sup>3</sup> INL and DNL are measured at V<sub>W</sub> with the RDAC configured as a potentiometer divider similar to a voltage output DAC. V<sub>A</sub> = V<sub>DD</sub> and V<sub>B</sub> = V<sub>SS</sub>. DNL specification limits of ±1 LSB maximum are guaranteed monotonic operating conditions (see Figure 28).

<sup>4</sup> Resistor Terminal A, Resistor Terminal B, and Resistor Terminal W have no limitations on polarity with respect to each other. Dual-supply operation enables ground-referenced bipolar signal adjustment.

<sup>5</sup> Guaranteed by design and not subject to production test.

<sup>6</sup> Common-mode leakage current is a measure of the dc leakage from any Terminal A, Terminal B, or Terminal W to a common-mode bias level of V<sub>DD</sub>/2.

<sup>7</sup> EEMEM restore mode current is not continuous. Current is consumed while EEMEM locations are read and transferred to the RDAC register.

<sup>8</sup> P<sub>DISS</sub> is calculated from (I<sub>DD</sub> × V<sub>DD</sub>) + (I<sub>SS</sub> × V<sub>SS</sub>).

<sup>9</sup> All dynamic characteristics use V<sub>DD</sub> = +2.5 V and V<sub>SS</sub> = -2.5 V.

**INTERFACE TIMING AND EEMEM RELIABILITY CHARACTERISTICS—25 kΩ, 250 kΩ VERSIONS**

Guaranteed by design and not subject to production test. See the Timing Diagrams section for the location of measured values. All input control voltages are specified with  $t_R = t_F = 2.5$  ns (10% to 90% of 3 V) and timed from a voltage level of 1.5 V. Switching characteristics are measured using both  $V_{DD} = 2.7$  V and  $V_{DD} = 5$  V.

**Table 2.**

Parameter	Symbol	Conditions	Min	Typ <sup>1</sup>	Max	Unit
Clock Cycle Time ( $t_{CYC}$ )	$t_1$		20			ns
$\overline{CS}$ Setup Time	$t_2$		10			ns
CLK Shutdown Time to $\overline{CS}$ Rise	$t_3$		1			$t_{CYC}$
Input Clock Pulse Width	$t_4, t_5$	Clock level high or low	10			ns
Data Setup Time	$t_6$	From positive CLK transition	5			ns
Data Hold Time	$t_7$	From positive CLK transition	5			ns
$\overline{CS}$ to SDO-SPI Line Acquire	$t_8$				40	ns
$\overline{CS}$ to SDO-SPI Line Release	$t_9$				50	ns
CLK to SDO Propagation Delay <sup>2</sup>	$t_{10}$	$R_P = 2.2$ kΩ, $C_L < 20$ pF			50	ns
CLK to SDO Data Hold Time	$t_{11}$	$R_P = 2.2$ kΩ, $C_L < 20$ pF	0			ns
$\overline{CS}$ High Pulse Width <sup>3</sup>	$t_{12}$		10			ns
$\overline{CS}$ High to $\overline{CS}$ High <sup>3</sup>	$t_{13}$		4			$t_{CYC}$
RDY Rise to $\overline{CS}$ Fall	$t_{14}$		0			ns
$\overline{CS}$ Rise to RDY Fall Time	$t_{15}$			0.15	0.3	ms
Store EEMEM Time <sup>4, 5</sup>	$t_{16}$	Applies to Instructions 0x2, 0x3		15	50	ms
Read EEMEM Time <sup>4</sup>	$t_{16}$	Applies to Instructions 0x8, 0x9, 0x10		7	30	μs
$\overline{CS}$ Rise to Clock Rise/Fall Setup	$t_{17}$		10			ns
Preset Pulse Width (Asynchronous) <sup>6</sup>	$t_{PRW}$		50			ns
Preset Response Time to Wiper Setting <sup>6</sup>	$t_{PRESP}$	$\overline{PR}$ pulsed low to refresh wiper positions		30		μs
Power-On EEMEM Restore Time <sup>6</sup>	$t_{EEMEM}$			30		μs
<b>FLASH/EE MEMORY RELIABILITY</b>						
Endurance <sup>7</sup>		$T_A = 25^\circ\text{C}$	100	1		MCycles kCycles
Data Retention <sup>8</sup>				100		Years

<sup>1</sup> Typicals represent average readings at 25°C and  $V_{DD} = 5$  V.

<sup>2</sup> Propagation delay depends on the value of  $V_{DD}$ ,  $R_{PULL-UP}$ , and  $C_L$ .

<sup>3</sup> Valid for commands that do not activate the RDY pin.

<sup>4</sup> The RDY pin is low only for Instruction 2, Instruction 3, Instruction 8, Instruction 9, Instruction 10, and the  $\overline{PR}$  hardware pulse: CMD\_8 ~ 20 μs; CMD\_9, CMD\_10 ~ 7 μs; CMD\_2, CMD\_3 ~ 15 ms;  $\overline{PR}$  hardware pulse ~ 30 μs.

<sup>5</sup> Store EEMEM time depends on the temperature and EEMEM writes cycles. Higher timing is expected at a lower temperature and higher write cycles.

<sup>6</sup> Not shown in Figure 2 and Figure 3.

<sup>7</sup> Endurance is qualified to 100,000 cycles per JEDEC Standard 22, Method A117 and measured at -40°C, +25°C, and +85°C.

<sup>8</sup> Retention lifetime equivalent at junction temperature ( $T_J$ ) = 85°C per JEDEC Standard 22, Method A117. Retention lifetime based on an activation energy of 1 eV derates with junction temperature in the Flash/EE memory.

Timing Diagrams

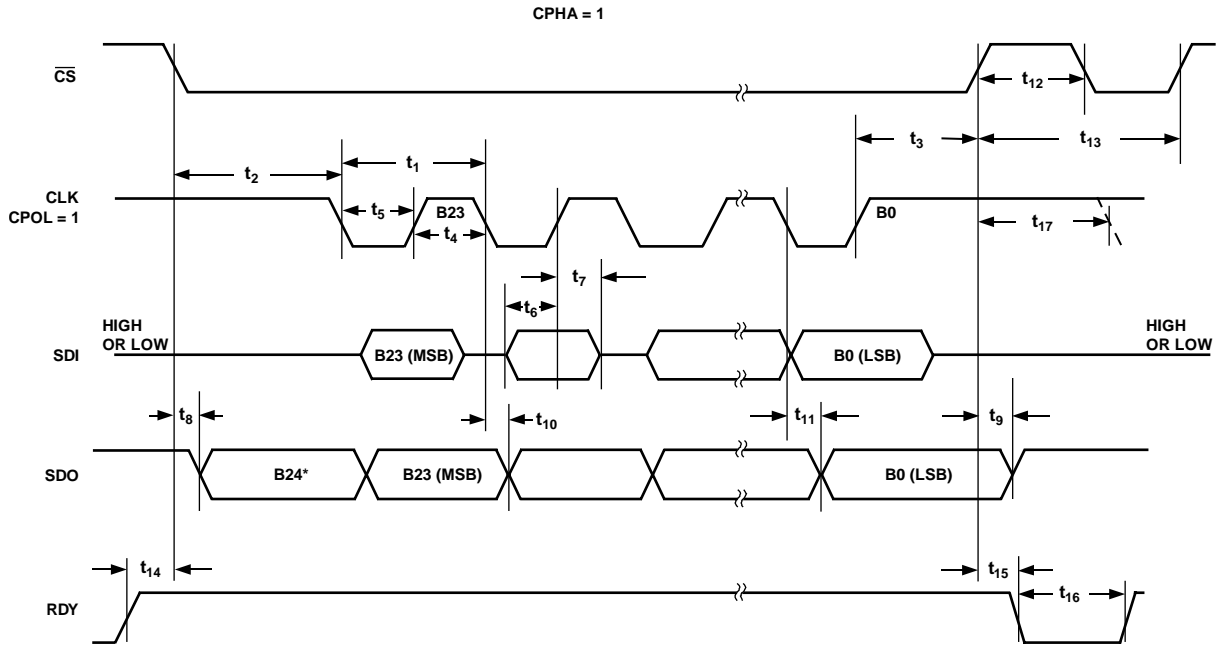

\*THE EXTRA BIT THAT IS NOT DEFINED IS NORMALLY THE LSB OF THE CHARACTER PREVIOUSLY TRANSMITTED. THE CPOL = 1 MICROCONTROLLER COMMAND ALIGNS THE INCOMING DATA TO THE POSITIVE EDGE OF THE CLOCK.

Figure 2. CPHA = 1 Timing Diagram



\*THE EXTRA BIT THAT IS NOT DEFINED IS NORMALLY THE MSB OF THE CHARACTER JUST RECEIVED. THE CPOL = 0 MICROCONTROLLER COMMAND ALIGNS THE INCOMING DATA TO THE POSITIVE EDGE OF THE CLOCK.

Figure 3. CPHA = 0 Timing Diagram

02816-002

02816-003

## ABSOLUTE MAXIMUM RATINGS

$T_A = 25^\circ\text{C}$ , unless otherwise noted.

Table 3.

Parameter	Rating
$V_{DD}$ to GND	-0.3 V to +7 V
$V_{SS}$ to GND	+0.3 V to -7 V
$V_{DD}$ to $V_{SS}$	7 V
$V_A, V_B, V_W$ to GND	$V_{SS} - 0.3 \text{ V}$ to $V_{DD} + 0.3 \text{ V}$
$I_A, I_B, I_W$	
Pulsed <sup>1</sup>	$\pm 20 \text{ mA}$
Continuous	$\pm 2 \text{ mA}$
Digital Input and Output Voltage to GND	-0.3 V to $V_{DD} + 0.3 \text{ V}$
Operating Temperature Range <sup>2</sup>	$-40^\circ\text{C}$ to $+85^\circ\text{C}$
Maximum Junction Temperature ( $T_J \text{ max}$ )	$150^\circ\text{C}$
Storage Temperature Range	$-65^\circ\text{C}$ to $+150^\circ\text{C}$
Lead Temperature, Soldering	
Vapor Phase (60 sec)	$215^\circ\text{C}$
Infrared (15 sec)	$220^\circ\text{C}$
Thermal Resistance	
Junction-to-Ambient $\theta_{JA}$ , TSSOP-16	$150^\circ\text{C/W}$
Junction-to-Case $\theta_{JC}$ , TSSOP-16	$28^\circ\text{C/W}$
Package Power Dissipation	$(T_J \text{ max} - T_A)/\theta_{JA}$

<sup>1</sup> Maximum terminal current is bounded by the maximum current handling of the switches, maximum power dissipation of the package, and maximum applied voltage across any two of the A, B, and W terminals at a given resistance.

<sup>2</sup> Includes programming of nonvolatile memory.

Stresses above those listed under Absolute Maximum Ratings may cause permanent damage to the device. This is a stress rating only; functional operation of the device at these or any other conditions above those indicated in the operational section of this specification is not implied. Exposure to absolute maximum rating conditions for extended periods may affect device reliability.

### ESD CAUTION



**ESD (electrostatic discharge) sensitive device.** Charged devices and circuit boards can discharge without detection. Although this product features patented or proprietary protection circuitry, damage may occur on devices subjected to high energy ESD. Therefore, proper ESD precautions should be taken to avoid performance degradation or loss of functionality.



## PIN CONFIGURATION AND FUNCTION DESCRIPTIONS



Figure 4. Pin Configuration

Table 4. Pin Function Descriptions

Pin No.	Mnemonic	Description
1	CLK	Serial Input Register Clock. Shifts in one bit at a time on positive clock edges.
2	SDI	Serial Data Input. Shifts in one bit at a time on positive clock CLK edges. MSB loads first.
3	SDO	Serial Data Output. Serves readback and daisy-chain functions. Command 9 and Command 10 activate the SDO output for the readback function, delayed by 24 or 25 clock pulses, depending on the clock polarity before and after the data-word (see Figure 2 and Figure 3). In other commands, the SDO shifts out the previously loaded SDI bit pattern, delayed by 24 or 25 clock pulses depending on the clock polarity (see Figure 2 and Figure 3). This previously shifted out SDI can be used for daisy-chaining multiple devices. Whenever SDO is used, a pull-up resistor in the range of 1 k $\Omega$ to 10 k $\Omega$ is needed.
4	GND	Ground Pin, Logic Ground Reference.
5	V <sub>SS</sub>	Negative Supply. Connect to 0V for single-supply applications. If V <sub>SS</sub> is used in dual supply, it must be able to sink 2 mA for 15 ms when storing data to EEMEM.
6	A1	Terminal A of RDAC1.
7	W1	Wiper terminal of RDAC1. ADDR (RDAC1) = 0x0.
8	B1	Terminal B of RDAC1.
9	B2	Terminal B of RDAC2.
10	W2	Wiper terminal of RDAC2. ADDR (RDAC2) = 0x1.
11	A2	Terminal A of RDAC2.
12	V <sub>DD</sub>	Positive Power Supply.
13	$\overline{WP}$	Optional Write Protect. When active low, $\overline{WP}$ prevents any changes to the present contents, except $\overline{PR}$ strobe. CMD_1 and COMD_8 refresh the RDAC register from EEMEM. Tie $\overline{WP}$ to V <sub>DD</sub> , if not used.
14	$\overline{PR}$	Optional Hardware Override Preset. Refreshes the scratchpad register with current contents of the EEMEM register. Factory default loads midscale until EEMEM is loaded with a new value by the user. $\overline{PR}$ is activated at the logic high transition. Tie $\overline{PR}$ to V <sub>DD</sub> , if not used.
15	$\overline{CS}$	Serial Register Chip Select Active Low. Serial register operation takes place when $\overline{CS}$ returns to logic high.
16	RDY	Ready. Active high open-drain output. Identifies completion of Instruction 2, Instruction 3, Instruction 8, Instruction 9, Instruction 10, and $\overline{PR}$ .

TYPICAL PERFORMANCE CHARACTERISTICS



Figure 5. INL vs. Code,  $T_A = -40^\circ\text{C}, +25^\circ\text{C}, +85^\circ\text{C}$  Overlay,  $R_{AB} = 25\text{ k}\Omega$

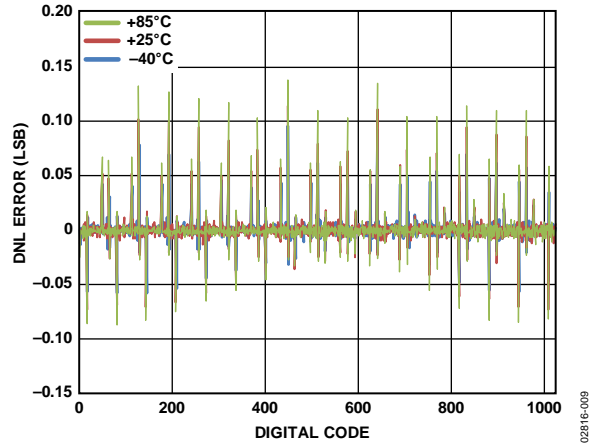

Figure 8. R-DNL vs. Code,  $T_A = -40^\circ\text{C}, +25^\circ\text{C}, +85^\circ\text{C}$  Overlay,  $R_{AB} = 25\text{ k}\Omega$



Figure 6. DNL vs. Code,  $T_A = -40^\circ\text{C}, +25^\circ\text{C}, +85^\circ\text{C}$  Overlay,  $R_{AB} = 25\text{ k}\Omega$

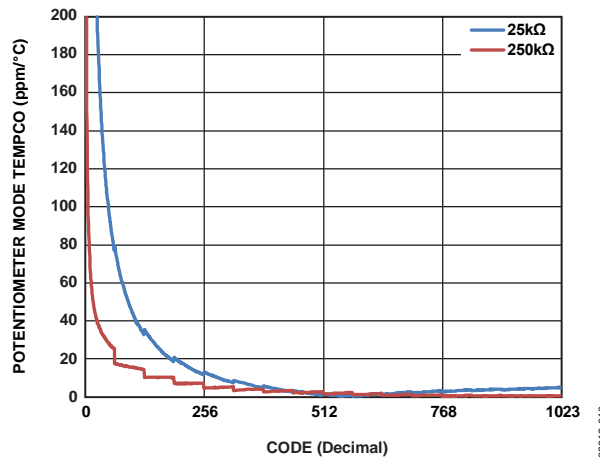

Figure 9.  $(\Delta V_w/V_w)/\Delta T \times 10^6$  Potentiometer Mode Tempco



Figure 7. R-INL vs. Code,  $T_A = -40^\circ\text{C}, +25^\circ\text{C}, +85^\circ\text{C}$  Overlay,  $R_{AB} = 25\text{ k}\Omega$

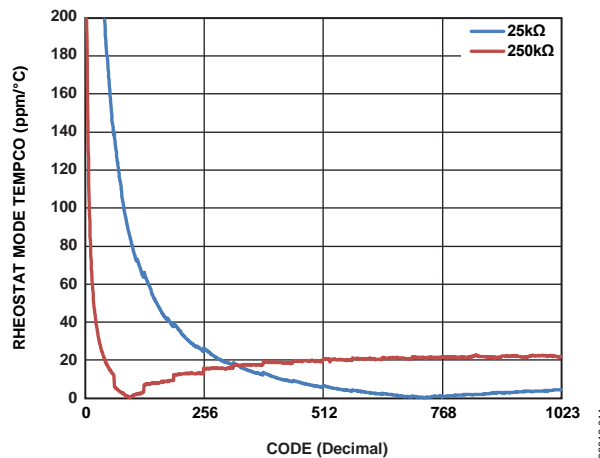

Figure 10.  $(\Delta R_{WB}/R_{WB})/\Delta T \times 10^6$  Rheostat Mode Tempco



Figure 11. Wiper On Resistance vs. Code

02816-012



Figure 14.  $I_{DD}$  vs. Digital Input Voltage

02816-015



Figure 12.  $I_{DD}$  vs. Temperature

02816-013



Figure 15. THD + Noise vs. Frequency

02816-115



Figure 13.  $I_{DD}$  vs. Clock Frequency,  $R_{AB} = 25\text{ k}\Omega$

02816-014



Figure 16. THD + Noise vs. Amplitude

02816-116



Figure 17. -3 dB Bandwidth vs. Resistance (See Figure 33)



Figure 20. PSRR vs. Frequency



Figure 18. Gain vs. Frequency vs. Code,  $R_{AB} = 25\text{ k}\Omega$  (See Figure 33)



Figure 21. Power-On Reset



Figure 19. Gain vs. Frequency vs. Code,  $R_{AB} = 250\text{ k}\Omega$  (See Figure 33)

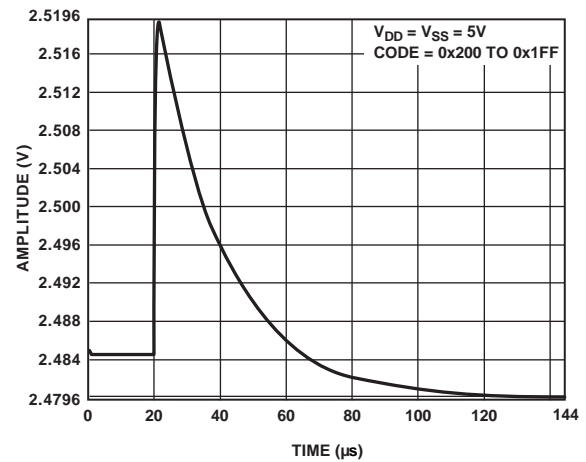

Figure 22. Midscale Glitch Energy,  $R_{AB} = 25\text{ k}\Omega$

02816-016

02816-019

02816-017

02816-020

02816-018

02816-021



Figure 23. Midscale Glitch Energy,  $R_{AB} = 250\text{ k}\Omega$

02816-022



Figure 25. Digital Feedthrough

02816-126

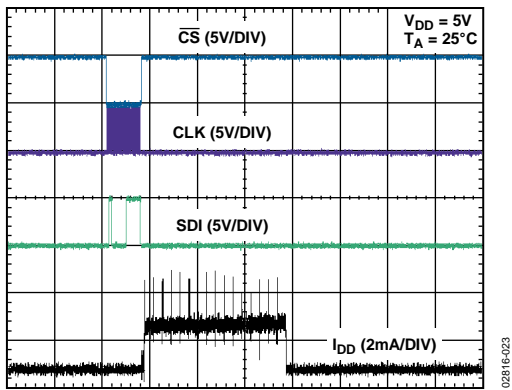

Figure 24.  $I_{DD}$  vs. Time when Storing Data to EEMEM

02816-023



Figure 26.  $I_{WB\_MAX}$  vs. Code

02816-025

TEST CIRCUITS

Figure 27 to Figure 37 define the test conditions used in the Specifications section.

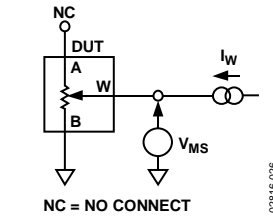

Figure 27. Resistor Position Nonlinearity Error (Rheostat Operation; R-INL, R-DNL)

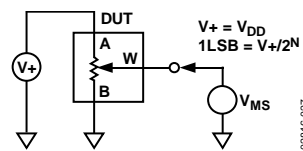

Figure 28. Potentiometer Divider Nonlinearity Error (INL, DNL)

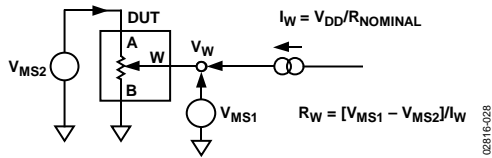

Figure 29. Wiper Resistance

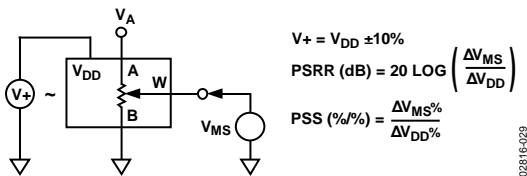

Figure 30. Power Supply Sensitivity (PSS, PSRR)

$$V_+ = V_{DD} \pm 10\%$$

$$PSRR \text{ (dB)} = 20 \text{ LOG} \left( \frac{\Delta V_{MS}}{\Delta V_{DD}} \right)$$

$$PSS \text{ (\%/\%)} = \frac{\Delta V_{MS}\%}{\Delta V_{DD}\%}$$

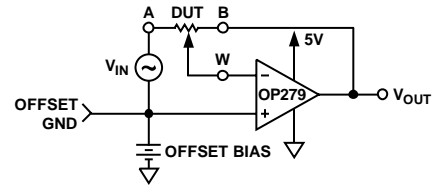

Figure 31. Inverting Gain

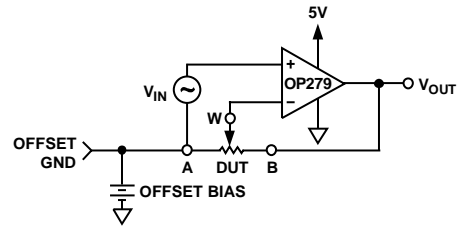

Figure 32. Noninverting Gain

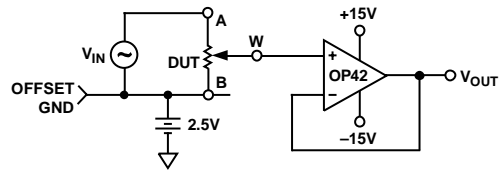

Figure 33. Gain vs. Frequency

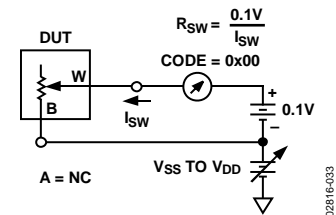

Figure 34. Incremental On Resistance



Figure 35. Common-Mode Leakage Current



Figure 37. Load Circuit for Measuring  $V_{OH}$  and  $V_{OL}$   
 (The diode bridge test circuit is equivalent to the application circuit with  $R_{PULL-UP}$  of 2.2 k $\Omega$ .)



Figure 36. Analog Crosstalk

## THEORY OF OPERATION

The AD5235 digital potentiometer is designed to operate as a true variable resistor. The resistor wiper position is determined by the RDAC register contents. The RDAC register acts as a scratchpad register, allowing unlimited changes of resistance settings. The scratchpad register can be programmed with any position setting using the standard SPI serial interface by loading the 24-bit data-word. In the format of the data-word, the first four bits are commands, the following four bits are addresses, and the last 16 bits are data. When a specified value is set, this value can be stored in a corresponding EEMEM register. During subsequent power-ups, the wiper setting is automatically loaded to that value.

Storing data to the EEMEM register takes about 15 ms and consumes approximately 2 mA. During this time, the shift register is locked, preventing any changes from taking place. The RDY pin pulses low to indicate the completion of this EEMEM storage. There are also 13 addresses with two bytes each of user-defined data that can be stored in the EEMEM register from Address 2 to Address 14.

The following instructions facilitate the programming needs of the user (see Table 7 for details):

0. Do nothing.
1. Restore EEMEM content to RDAC.
2. Store RDAC setting to EEMEM.
3. Store RDAC setting or user data to EEMEM.
4. Decrement by 6 dB.
5. Decrement all by 6 dB.
6. Decrement by one step.
7. Decrement all by one step.
8. Reset EEMEM content to RDAC.
9. Read EEMEM content from SDO.
10. Read RDAC wiper setting from SDO.
11. Write data to RDAC.
12. Increment by 6 dB.
13. Increment all by 6 dB.
14. Increment by one step.
15. Increment all by one step.

Table 14 to Table 20 provide programming examples that use some of these commands.

## SCRATCHPAD AND EEMEM PROGRAMMING

The scratchpad RDAC register directly controls the position of the digital potentiometer wiper. For example, when the scratchpad register is loaded with all 0s, the wiper is connected to Terminal B of the variable resistor. The scratchpad register is a standard logic register with no restriction on the number of changes allowed, but the EEMEM registers have a program erase/write cycle limitation.

## BASIC OPERATION

The basic mode of setting the variable resistor wiper position (programming the scratchpad register) is accomplished by loading the serial data input register with Instruction 11 (0xB), Address 0, and the desired wiper position data. When the proper wiper position is determined, the user can load the serial data input register with Instruction 2 (0x2), which stores the wiper position data in the EEMEM register. After 15 ms, the wiper position is permanently stored in nonvolatile memory.

Table 5 provides a programming example listing the sequence of the serial data input (SDI) words with the serial data output appearing at the SDO pin in hexadecimal format.

**Table 5. Write and Store RDAC Settings to EEMEM Registers**

SDI	SDO	Action
0xB00100	0xFFFFFFFF	Writes data 0x100 to the RDAC1 register, Wiper W1 moves to 1/4 full-scale position.
0x20XXXX	0xB00100	Stores RDAC1 register content into the EEMEM1 register.
0xB10200	0x20XXXX	Writes Data 0x200 to the RDAC2 register, Wiper W2 moves to 1/2 full-scale position.
0x21XXXX	0xB10200	Stores RDAC2 register contents into the EEMEM2 register.

At system power-on, the scratchpad register is automatically refreshed with the value previously stored in the corresponding EEMEM register. The factory-preset EEMEM value is midscale. The scratchpad register can also be refreshed with the contents of the EEMEM register in three different ways. First, executing Instruction 1 (0x1) restores the corresponding EEMEM value. Second, executing Instruction 8 (0x8) resets the EEMEM values of both channels. Finally, pulsing the  $\overline{\text{PR}}$  pin refreshes both EEMEM settings. Operating the hardware control  $\overline{\text{PR}}$  function requires a complete pulse signal. When  $\overline{\text{PR}}$  goes low, the internal logic sets the wiper at midscale. The EEMEM value is not loaded until  $\overline{\text{PR}}$  returns high.



**EEMEM PROTECTION**

The write protect ( $\overline{WP}$ ) pin disables any changes to the scratchpad register contents, except for the EEMEM setting, which can still be restored using Instruction 1, Instruction 8, and the  $\overline{PR}$  pulse. Therefore,  $\overline{WP}$  can be used to provide a hardware EEMEM protection feature.

**DIGITAL INPUT AND OUTPUT CONFIGURATION**

All digital inputs are ESD protected, high input impedance that can be driven directly from most digital sources. Active at logic low,  $\overline{PR}$  and  $\overline{WP}$  must be tied to  $V_{DD}$ , if they are not used. No internal pull-up resistors are present on any digital input pins. To avoid floating digital pins that might cause false triggering in a noisy environment, add pull-up resistors. This is applicable when the device is detached from the driving source when it is programmed.

The SDO and RDY pins are open-drain digital outputs that only need pull-up resistors if these functions are used. To optimize the speed and power trade-off, use 2.2 k $\Omega$  pull-up resistors.

The equivalent serial data input and output logic is shown in Figure 38. The open-drain output SDO is disabled whenever chip-select ( $\overline{CS}$ ) is in logic high. ESD protection of the digital inputs is shown in Figure 39 and Figure 40.



Figure 38. Equivalent Digital Input and Output Logic



Figure 39. Equivalent ESD Digital Input Protection



Figure 40. Equivalent  $\overline{WP}$  Input Protection

**SERIAL DATA INTERFACE**

The AD5235 contains a 4-wire SPI-compatible digital interface (SDI, SDO,  $\overline{CS}$ , and CLK). The 24-bit serial data-word must be loaded with MSB first. The format of the word is shown in Table 6. The command bits (C0 to C3) control the operation of the digital potentiometer according to the command shown in Table 7. A0 to A3 are the address bits. A0 is used to address RDAC1 or RDAC2. Address 2 to Address 14 are accessible by users for extra EEMEM. Address 15 is reserved for factory usage. Table 9 provides an address map of the EEMEM locations. D0 to D9 are the values for the RDAC registers. D0 to D15 are the values for the EEMEM registers.

The AD5235 has an internal counter that counts a multiple of 24 bits (a frame) for proper operation. For example, AD5235 works with a 24-bit or 48-bit word, but it cannot work properly with a 23-bit or 25-bit word. To prevent data from mislocking (due to noise, for example), the counter resets, if the count is not a multiple of four when  $\overline{CS}$  goes high but remains in the register if it is multiple of four. In addition, the AD5235 has a subtle feature that, if  $\overline{CS}$  is pulsed without CLK and SDI, the part repeats the previous command (except during power-up). As a result, care must be taken to ensure that no excessive noise exists in the CLK or  $\overline{CS}$  line that might alter the effective number-of-bits pattern.

The SPI interface can be used in two slave modes: CPHA = 1, CPOL = 1 and CPHA = 0, CPOL = 0. CPHA and CPOL refer to the control bits that dictate SPI timing in the following MicroConverters® and microprocessors: ADuC812, ADuC824, M68HC11, MC68HC16R1, and MC68HC916R1.

## DAISY-CHAIN OPERATION

The serial data output pin (SDO) serves two purposes. It can be used to read the contents of the wiper setting and EEMEM values using Instruction 10 and Instruction 9, respectively. The remaining instructions (Instruction 0 to Instruction 8, Instruction 11 to Instruction 15) are valid for daisy-chaining multiple devices in simultaneous operations. Daisy-chaining minimizes the number of port pins required from the controlling IC (see Figure 41). The SDO pin contains an open-drain N-Ch FET that requires a pull-up resistor, if this function is used. As shown in Figure 41, users need to tie the SDO pin of one package to the SDI pin of the next package. Users may need to increase the clock period because the pull-up resistor and the capacitive loading at the SDO-to-SDI interface may require additional time delay between subsequent devices.

When two AD5235s are daisy-chained, 48 bits of data are required. The first 24 bits (formatted 4-bit command, 4-bit address, and 16-bit data) go to U2, and the second 24 bits with the same format go to U1. Keep  $\overline{CS}$  low until all 48 bits are clocked into their respective serial registers.  $\overline{CS}$  is then pulled high to complete the operation.



Figure 41. Daisy-Chain Configuration Using SDO

## TERMINAL VOLTAGE OPERATING RANGE

The positive  $V_{DD}$  and negative  $V_{SS}$  power supplies of the AD5235 define the boundary conditions for proper 3-terminal digital potentiometer operation. Supply signals present on Terminal A, Terminal B, and Terminal W that exceed  $V_{DD}$  or  $V_{SS}$  are clamped by the internal forward-biased diodes (see Figure 42).



Figure 42. Maximum Terminal Voltages Set by  $V_{DD}$  and  $V_{SS}$

The GND pin of the AD5235 is primarily used as a digital ground reference. To minimize the digital ground bounce, the AD5235 ground terminal should be joined remotely to the common ground (see Figure 43). The digital input control signals to the AD5235 must be referenced to the device ground pin (GND) and must satisfy the logic level defined in the Specifications section. An internal level-shift circuit ensures that the common-mode voltage range of the three terminals extends from  $V_{SS}$  to  $V_{DD}$ , regardless of the digital input level.

## Power-Up Sequence

Because there are diodes to limit the voltage compliance at Terminal A, Terminal B, and Terminal W (see Figure 42), it is important to power  $V_{DD}$  and  $V_{SS}$  first before applying any voltage to Terminal A, Terminal B, and Terminal W. Otherwise, the diode is forward-biased such that  $V_{DD}$  and  $V_{SS}$  are powered unintentionally. For example, applying 5 V across Terminal A and Terminal B prior to  $V_{DD}$  causes the  $V_{DD}$  terminal to exhibit 4.3 V. It is not destructive to the device, but it might affect the rest of the user's system. The ideal power-up sequence is GND,  $V_{DD}$  and  $V_{SS}$ , digital inputs, and  $V_A$ ,  $V_B$ , and  $V_W$ . The order of powering  $V_A$ ,  $V_B$ ,  $V_W$ , and the digital inputs is not important as long as they are powered after  $V_{DD}$  and  $V_{SS}$ .

Regardless of the power-up sequence and the ramp rates of the power supplies, when  $V_{DD}$  and  $V_{SS}$  are powered, the power-on preset activates, which restores the EEMEM values to the RDAC registers.

## Layout and Power Supply Bypassing

It is a good practice to employ compact, minimum lead-length layout design. The leads to the input should be as direct as possible with a minimum conductor length. Ground paths should have low resistance and low inductance.

Similarly, it is good practice to bypass the power supplies with quality capacitors for optimum stability. Bypass supply leads to the device with 0.01  $\mu\text{F}$  to 0.1  $\mu\text{F}$  disk or chip ceramic capacitors. Also, apply low ESR, 1  $\mu\text{F}$  to 10  $\mu\text{F}$  tantalum or electrolytic capacitors at the supplies to minimize any transient disturbance (see Figure 43).

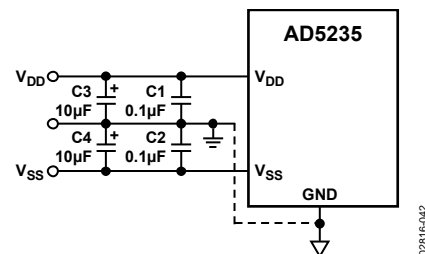

Figure 43. Power Supply Bypassing

In Table 6, command bits are C0 to C3, address bits are A0 to A3, Data Bit D0 to Data Bit D9 are applicable to RDAC, and D0 to D15 are applicable to EEMEM.

Table 6. 24-Bit Serial Data-Word

	MSB								Command Byte 0								Data Byte 1								Data Byte 0								LSB
RDAC	C3	C2	C1	C0	0	0	0	A0	X	X	X	X	X	X	D9	D8	D7	D6	D5	D4	D3	D2	D1	D0									
EEMEM	C3	C2	C1	C0	A3	A2	A1	A0	D15	D14	D13	D12	D11	D10	D9	D8	D7	D6	D5	D4	D3	D2	D1	D0									

Command instruction codes are defined in Table 7.

Table 7. Command Operation Truth Table<sup>1, 2, 3</sup>

Command Number	Command Byte 0								Data Byte 1				Data Byte 0			Operation
	B23				B16				B15	B8			B7	B0		
	C3	C2	C1	C0	A3	A2	A1	A0	X	...	D9	D8	D7	...	D0	
0	0	0	0	0	X	X	X	X	X	...	X	X	X	...	X	NOP. Do nothing. See Table 19
1	0	0	0	1	0	0	0	A0	X	...	X	X	X	...	X	Restore EEMEM (A0) contents to RDAC (A0) register. See Table 16.
2	0	0	1	0	0	0	0	A0	X	...	X	X	X	...	X	Store wiper setting. Store RDAC (A0) setting to EEMEM (A0). See Table 15.
3 <sup>4</sup>	0	0	1	1	A3	A2	A1	A0	D15	...		D8	D7	...	D0	Store contents of Serial Register Data Byte 0 and Serial Register Data Bytes 1 (total 16 bits) to EEMEM (ADDR). See Table 18.
4 <sup>5</sup>	0	1	0	0	0	0	0	A0	X	...	X	X	X	...	X	Decrement by 6 dB. Right-shift contents of RDAC (A0) register, stop at all 0s.
5 <sup>5</sup>	0	1	0	1	X	X	X	X	X	...	X	X	X	...	X	Decrement all by 6 dB. Right-shift contents of all RDAC registers, stop at all 0s.
6 <sup>5</sup>	0	1	1	0	0	0	0	A0	X	...	X	X	X	...	X	Decrement contents of RDAC (A0) by 1, stop at all 0s.
7 <sup>5</sup>	0	1	1	1	X	X	X	X	X	...	X	X	X	...	X	Decrement contents of all RDAC registers by 1, stop at all 0s.
8	1	0	0	0	0	0	0	0	X	...	X	X	X	...	X	Reset. Refresh all RDACs with their corresponding EEMEM previously stored values.
9	1	0	0	1	A3	A2	A1	A0	X	...	X	X	X	...	X	Read contents of EEMEM (ADDR) from SDO output in the next frame. See Table 19.
10	1	0	1	0	0	0	0	A0	X	...	X	X	X	...	X	Read RDAC wiper setting from SDO output in the next frame. See Table 20.
11	1	0	1	1	0	0	0	A0	X	...	D9	D8	D7	...	D0	Write contents of Serial Register Data Byte 0 and Serial Register Data Byte 1 (total 10 bits) to RDAC (A0). See Table 14.
12 <sup>5</sup>	1	1	0	0	0	0	0	A0	X	...	X	X	X	...	X	Increment by 6 dB: Left-shift contents of RDAC (A0), stop at all 1s. See Table 17.
13 <sup>5</sup>	1	1	0	1	X	X	X	X	X	...	X	X	X	...	X	Increment all by 6 dB. Left-shift contents of all RDAC registers, stop at all 1s.
14 <sup>5</sup>	1	1	1	0	0	0	0	A0	X	...	X	X	X	...	X	Increment contents of RDAC (A0) by 1, stop at all 1s. See Table 15.
15 <sup>5</sup>	1	1	1	1	X	X	X	X	X	...	X	X	X	...	X	Increment contents of all RDAC registers by 1, stop at all 1s.

<sup>1</sup> The SDO output shifts out the last 24 bits of data clocked into the serial register for daisy-chain operation. Exception: for any instruction following Instruction 9 or Instruction 10, the selected internal register data is present in Data Byte 0 and Data Byte 1. The instructions following Instruction 9 and Instruction 10 must also be a full 24-bit data-word to completely clock out the contents of the serial register.

<sup>2</sup> The RDAC register is a volatile scratchpad register that is refreshed at power-on from the corresponding nonvolatile EEMEM register.

<sup>3</sup> Execution of these operations takes place when the  $\overline{CS}$  strobe returns to logic high.

<sup>4</sup> Instruction 3 writes two data bytes (16 bits of data) to EEMEM. In the case of Address 0 and Address 1, only the last 10 bits are valid for wiper position setting.

<sup>5</sup> The increment, decrement, and shift instructions ignore the contents of the shift register, Data Byte 0 and Data Byte 1.

**ADVANCED CONTROL MODES**

The AD5235 digital potentiometer includes a set of user programming features to address the wide number of applications for these universal adjustment devices.

Key programming features include the following:

- Scratchpad programming to any desirable values
- Nonvolatile memory storage of the scratchpad RDAC register value in the EEMEM register
- Increment and decrement instructions for the RDAC wiper register
- Left and right bit shift of the RDAC wiper register to achieve ±6 dB level changes
- 26 extra bytes of user-addressable nonvolatile memory

**Linear Increment and Decrement Instructions**

The increment and decrement instructions (Instruction 14, Instruction 15, Instruction 6, and Instruction 7) are useful for linear step adjustment applications. These commands simplify microcontroller software coding by allowing the controller to send just an increment or decrement command to the device. The adjustment can be individual or in a ganged potentiometer arrangement where both wiper positions are changed at the same time.

For an increment command, executing Instruction 14 automatically moves the wiper to the next resistance segment position. The master increment command, Instruction 15, moves all resistor wipers up by one position.

**Logarithmic Taper Mode Adjustment**

Four programming instructions produce logarithmic taper increment and decrement of the wiper position control by an individual potentiometer or by a ganged potentiometer arrangement where both wiper positions are changed at the same time. The 6 dB increment is activated by Instruction 12 and Instruction 13, and the 6 dB decrement is activated by Instruction 4 and Instruction 5. For example, starting with the wiper connected to Terminal B, executing 11 increment instructions (Command Instruction 12) moves the wiper in 6 dB steps from 0% of the  $R_{AB}$  (Terminal B) position to 100% of the  $R_{AB}$  position of the AD5235 10-bit potentiometer. When the wiper position is near the maximum setting, the last 6 dB increment instruction causes the wiper to go to the full-scale 1023 code position. Further 6 dB per increment instructions do not change the wiper position beyond its full scale (see Table 8).

The 6 dB step increments and 6 dB step decrements are achieved by shifting the bit internally to the left or right, respectively. The following information explains the nonideal ±6 dB step adjustment under certain conditions. Table 8 illustrates the operation of the shifting function on the RDAC register data bits. Each table row represents a successive shift operation. Note that the left-shift 12 and 13 instructions were modified such that, if the data in the RDAC register is equal to zero and the data is shifted left,

the RDAC register is then set to Code 1. Similarly, if the data in the RDAC register is greater than or equal to midscale and the data is shifted left, then the data in the RDAC register is automatically set to full scale. This makes the left-shift function as ideal a logarithmic adjustment as possible.

The Right-Shift 4 instruction and Right-Shift 5 instruction are ideal only if the LSB is 0 (ideal logarithmic = no error). If the LSB is 1, the right-shift function generates a linear half-LSB error, which translates to a number-of-bits dependent logarithmic error, as shown in Figure 44. Figure 44 shows the error of the odd numbers of bits for the AD5235.

**Table 8. Detail Left-Shift and Right-Shift Functions for 6 dB Step Increment and Decrement**

Left-Shift (+6 dB/Step)	Right-Shift(-6 dB/Step)
00 0000 0000	11 1111 1111
00 0000 0001	01 1111 1111
00 0000 0010	00 1111 1111
00 0000 0100	00 0111 1111
00 0000 1000	00 0011 1111
00 0001 0000	00 0001 1111
00 0010 0000	00 0000 1111
00 0100 0000	00 0000 0111
00 1000 0000	00 0000 0011
01 0000 0000	00 0000 0001
10 0000 0000	00 0000 0000
11 1111 1111	00 0000 0000
11 1111 1111	00 0000 0000

Actual conformance to a logarithmic curve between the data contents in the RDAC register and the wiper position for each Right-Shift 4 command and Right-Shift 5 command execution contains an error only for odd numbers of bits. Even numbers of bits are ideal. Figure 44 shows plots of log error [ $20 \times \log_{10}(\text{error/code})$ ] for the AD5235. For example, Code 3 log error =  $20 \times \log_{10}(0.5/3) = -15.56$  dB, which is the worst case. The log error plot is more significant at the lower codes (see Figure 44).



Figure 44. Log Error Conformance for Odd Numbers of Bits Only (Even Numbers of Bits Are Ideal)

**Using  $\overline{CS}$  to Re-Execute a Previous Command**

Another subtle feature of the AD5235 is that a subsequent  $\overline{CS}$  strobe, without clock and data, repeats a previous command.

**Using Additional Internal Nonvolatile EEMEM**

The AD5235 contains additional user EEMEM registers for storing any 16-bit data such as memory data for other components, look-up tables, or system identification information. Table 9 provides an address map of the internal storage registers shown in the functional block diagram (see Figure 1) as EEMEM1, EEMEM2, and 26 bytes (13 addresses  $\times$  2 bytes each) of User EEMEM.

**Table 9. EEMEM Address Map**

EEMEM No.	Address	EEMEM Content for ...
1	0000	RDAC1 <sup>1</sup>
2	0001	RDAC2
3	0010	USER1 <sup>2</sup>
4	0011	USER2
...	...	...
15	1110	USER13
16	1111	R <sub>AB1</sub> tolerance <sup>3</sup>

<sup>1</sup> RDAC data stored in EEMEM locations is transferred to the corresponding RDAC register at power-on, or when Instruction 1, Instruction 8, and PR are executed.

<sup>2</sup> USERx are internal nonvolatile EEMEM registers available to store and retrieve constants and other 16-bit information using Instruction 3 and Instruction 9, respectively.

<sup>3</sup> Read only.

**Calculating Actual End-to-End Terminal Resistance**

The resistance tolerance is stored in the EEMEM register during factory testing. The actual end-to-end resistance can, therefore, be calculated, which is valuable for calibration, tolerance matching, and precision applications. Note that this value is read only and the R<sub>AB2</sub> matches with R<sub>AB1</sub>, typically 0.1%.

The resistance tolerance in percentage is contained in the last 16 bits of data in EEMEM Register 15. The format is the sign magnitude binary format with the MSB designate for sign (0 = negative and 1 = positive), the next 7 MSB designate the integer number, and the 8 LSB designate the decimal number (see Table 11).

**Table 11. Calculating End-to-End Terminal Resistance**

Bit	D15	D14	D13	D12	D11	D10	D9	D8
Sign								
Mag	Sign	2 <sup>6</sup>	2 <sup>5</sup>	2 <sup>4</sup>	2 <sup>3</sup>	2 <sup>2</sup>	2 <sup>1</sup>	2 <sup>0</sup>

7 Bits for Integer Number

For example, if R<sub>AB\_RATED</sub> = 250 k $\Omega$  and the data in the SDO shows XXXX XXXX 1001 1100 0000 1111, R<sub>AB\_ACTUAL</sub> can be calculated as follows:

- MSB: 1 = positive
- Next 7 LSB: 001 1100 = 28
- 8 LSB: 0000 1111 =  $15 \times 2^{-8} = 0.06$
- % tolerance = 28.06%
- Therefore, R<sub>AB\_ACTUAL</sub> = 320.15 k $\Omega$

**RDAC STRUCTURE**

The patent-pending RDAC contains multiple strings of equal resistor segments with an array of analog switches that acts as the wiper connection. The number of positions is the resolution of the device. The AD5235 has 1024 connection points, allowing it to provide better than 0.1% setability resolution. Figure 45 shows an equivalent structure of the connections among the three terminals of the RDAC. The SW<sub>A</sub> and SW<sub>B</sub> are always on, while the switches, SW(0) to SW(2<sup>N</sup> - 1), are on one at a time, depending on the resistance position decoded from the data bits. Because the switch is not ideal, there is a 50  $\Omega$  wiper resistance, R<sub>W</sub>. Wiper resistance is a function of supply voltage and temperature. The lower the supply voltage or the higher the temperature, the higher the resulting wiper resistance. Users should be aware of the wiper resistance dynamics, if accurate prediction of the output resistance is needed.



Figure 45. Equivalent RDAC Structure

**Table 10. Nominal Individual Segment Resistor Values**

Device Resolution	25 k $\Omega$	250 k $\Omega$
1024-Step	24.4	244

D7	D6	D5	D4	D3	D2	D1	D0
2 <sup>-1</sup>	2 <sup>-2</sup>	2 <sup>-3</sup>	2 <sup>-4</sup>	2 <sup>-5</sup>	2 <sup>-6</sup>	2 <sup>-7</sup>	2 <sup>-8</sup>

8 Bits for Decimal Number

Decimal Point

## PROGRAMMING THE VARIABLE RESISTOR

### Rheostat Operation

The nominal resistance of the RDAC between Terminal A and Terminal B,  $R_{AB}$ , is available with 25 k $\Omega$  and 250 k $\Omega$  with 1024 positions (10-bit resolution). The final digits of the part number determine the nominal resistance value, for example, 25 k $\Omega$  = 24.4  $\Omega$ ; 250 k $\Omega$  = 244  $\Omega$ .

The 10-bit data-word in the RDAC latch is decoded to select one of the 1024 possible settings. The following description provides the calculation of resistance,  $R_{WB}$ , at different codes of a 25 k $\Omega$  part. The first connection of the wiper starts at Terminal B for Data 0x000.  $R_{WB}(0)$  is 30  $\Omega$  because of the wiper resistance, and it is independent of the nominal resistance. The second connection is the first tap point where  $R_{WB}(1)$  becomes 24.4  $\Omega$  + 30  $\Omega$  = 54.4  $\Omega$  for Data 0x001. The third connection is the next tap point representing  $R_{WB}(2)$  = 48.8  $\Omega$  + 30  $\Omega$  = 78.8  $\Omega$  for Data 0x002, and so on. Each LSB data value increase moves the wiper up the resistor ladder until the last tap point is reached at  $R_{WB}(1023)$  = 25006  $\Omega$ . See Figure 45 for a simplified diagram of the equivalent RDAC circuit. When  $R_{WB}$  is used, Terminal A can be left floating or tied to the wiper.

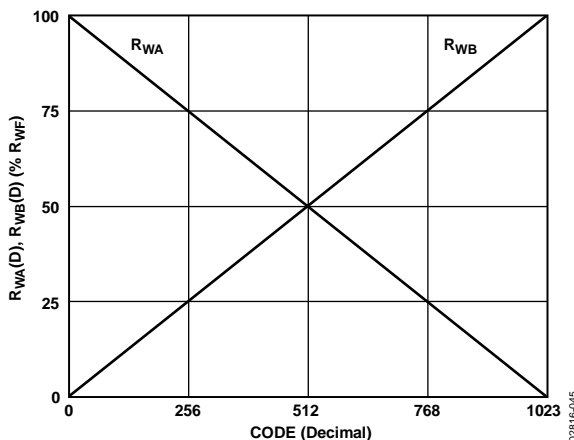

Figure 46.  $R_{WA}(D)$  and  $R_{WB}(D)$  vs. Decimal Code

The general equation that determines the programmed output resistance between Terminal Bx and Terminal Wx is

$$R_{WB}(D) = \frac{D}{1024} \times R_{AB} + R_W \quad (1)$$

where:

$D$  is the decimal equivalent of the data contained in the RDAC register.

$R_{AB}$  is the nominal resistance between Terminal A and Terminal B.

$R_W$  is the wiper resistance.

For example, the output resistance values in Table 12 are set for the given RDAC latch codes (applies to  $R_{AB}$  = 25 k $\Omega$  digital potentiometers).

Table 12.  $R_{WB}(D)$  at Selected Codes for  $R_{AB}$  = 25 k $\Omega$

D (Dec)	$R_{WB}(D)$ ( $\Omega$ )	Output State
1023	25,006	Full scale
512	12,530	Midscale
1	54.4	1 LSB
0	30	Zero scale (wiper contact resistor)

Note that, in the zero-scale condition, a finite wiper resistance of 50  $\Omega$  is present. Care should be taken to limit the current flow between W and B in this state to no more than 20 mA to avoid degradation or possible destruction of the internal switches.

Like the mechanical potentiometer that the RDAC replaces, the AD5235 part is symmetrical. The resistance between Wiper W and Terminal A also produces a digitally controlled complementary resistance,  $R_{WA}$ . Figure 46 shows the symmetrical programmability of the various terminal connections. When  $R_{WA}$  is used, Terminal B can be left floating or tied to the wiper. Setting the resistance value for  $R_{WA}$  starts at a maximum value of resistance and decreases as the data loaded in the latch is increased in value.

The general transfer equation for this operation is

$$R_{WA}(D) = \frac{1024 - D}{1024} \times R_{AB} + R_W \quad (2)$$

For example, the output resistance values in Table 13 are set for the given RDAC latch codes (applies to  $R_{AB}$  = 25 k $\Omega$  digital potentiometers).

Table 13.  $R_{WA}(D)$  at Selected Codes for  $R_{AB}$  = 25 k $\Omega$

D (Dec)	$R_{WA}(D)$ ( $\Omega$ )	Output State
1023	54.4	Full scale
512	12,530	Midscale
1	25,006	1 LSB
0	25,030	Zero scale (wiper contact resistance)

The typical distribution of  $R_{AB}$  from channel to channel is  $\pm 0.2\%$  within the same package. Device-to-device matching is process lot dependent upon the worst case of  $\pm 30\%$  variation. However, the change in  $R_{AB}$  with temperature has a 35 ppm/ $^{\circ}\text{C}$  temperature coefficient.

## PROGRAMMING THE POTENTIOMETER DIVIDER

### Voltage Output Operation

The digital potentiometer can be configured to generate an output voltage at the wiper terminal that is proportional to the input voltages applied to Terminal A and Terminal B. For example, connecting Terminal A to 5 V and Terminal B to ground produces an output voltage at the wiper that can be any value from 0 V to 5 V. Each LSB of voltage is equal to the voltage applied across Terminal A to Terminal B divided by the  $2^N$  position resolution of the potentiometer divider.

Because the AD5235 can also be supplied by dual supplies, the general equation defining the output voltage at  $V_W$  with respect to ground for any given input voltages applied to Terminal A and Terminal B is

$$V_W(D) = \frac{D}{1024} \times V_{AB} + V_B \quad (3)$$

Equation 3 assumes that  $V_W$  is buffered so that the effect of wiper resistance is minimized. Operation of the digital potentiometer in divider mode results in more accurate operation over temperature. Here, the output voltage is dependent on the ratio of the internal resistors and not the absolute value; therefore, the drift improves to 15 ppm/°C. There is no voltage polarity restriction between Terminal A, Terminal B, and Terminal W as long as the terminal voltage ( $V_{TERM}$ ) stays within  $V_{SS} < V_{TERM} < V_{DD}$ .

### PROGRAMMING EXAMPLES

The following programming examples illustrate a typical sequence of events for various features of the AD5235. See Table 7 for the instructions and data-word format. The instruction numbers, addresses, and data appearing at the SDI and SDO pins are in hexadecimal format.

**Table 14. Scratchpad Programming**

SDI	SDO	Action
0xB00100	0XXXXXX	Writes Data 0x100 into RDAC1 register, Wiper W1 moves to 1/4 full-scale position.
0xB10200	0xB00100	Loads Data 0x200 into RDAC2 register, Wiper W2 moves to 1/2 full-scale position.

**Table 15. Incrementing RDAC Followed by Storing the Wiper Setting to EEMEM**

SDI	SDO	Action
0xB00100	0XXXXXX	Writes Data 0x100 into RDAC1 register, Wiper W1 moves to 1/4 full-scale position.
0xE0XXXX	0xB00100	Increments RDAC1 register by one to 0x101.
0xE0XXXX	0xE0XXXX	Increments RDAC1 register by one to 0x102. Continue until desired wiper position is reached.
0x20XXXX	0XXXXXX	Stores RDAC2 register data into EEMEM1. Optionally, tie WP to GND to protect EEMEM values.

The EEMEM values for the RDACs can be restored by power-on, by strobing the PR pin, or by the two commands shown in Table 16.

**Table 16. Restoring the EEMEM Values to RDAC Registers**

SDI	SDO	Action
0x10XXXX	0XXXXXX	Restores the EEMEM1 value to the RDAC1 register.

**Table 17. Using Left-Shift by One to Increment 6 dB Steps**

SDI	SDO	Action
0xC0XXXX	0XXXXXX	Moves Wiper 1 to double the present data contained in the RDAC1 register.
0xC1XXXX	0xC0XXXX	Moves Wiper 2 to double the present data contained in the RDAC2 register.

**Table 18. Storing Additional User Data in EEMEM**

SDI	SDO	Action
0x32AAAA	0XXXXXX	Stores Data 0xAAAA in the extra EEMEM location USER1. (Allowable to address in 13 locations with a maximum of 16 bits of data.)
0x335555	0x32AAAA	Stores Data 0x5555 in the extra EEMEM location USER2. (Allowable to address in 13 locations with a maximum of 16 bits of data.)

**Table 19. Reading Back Data from Memory Locations**

SDI	SDO	Action
0x92XXXX	0XXXXXX	Prepares data read from USER1 EEMEM location.
0x00XXXX	0x92AAAA	NOP Instruction 0 sends a 24-bit word out of SDO, where the last 16 bits contain the contents in USER1 EEMEM location.

**Table 20. Reading Back Wiper Settings**

SDI	SDO	Action
0xB00200	0XXXXXX	Writes RDAC1 to midscale.
0xC0XXXX	0xB00200	Doubles RDAC1 from midscale to full scale.
0xA0XXXX	0xC0XXXX	Prepares reading wiper setting from RDAC1 register.
0XXXXXX	0xA003FF	Reads back full-scale value from SDO.

### EVAL-AD5235SDZ EVALUATION KIT

Analog Devices, Inc., offers a user-friendly EVAL-AD5235SDZ evaluation kit that can be controlled by a PC in conjunction with the SDP platform. The driving program is self-contained; no programming languages or skills are needed.

## APPLICATIONS INFORMATION

### BIPOLAR OPERATION FROM DUAL SUPPLIES

The AD5235 can be operated from  $\pm 2.5$  V dual supplies, which enable control of ground referenced ac signals or bipolar operation. AC signals as high as  $V_{DD}$  and  $V_{SS}$  can be applied directly across Terminal A to Terminal B with the output taken from Terminal W. See Figure 47 for a typical circuit connection.



Figure 47. Bipolar Operation from Dual Supplies

### GAIN CONTROL COMPENSATION

A digital potentiometer is commonly used in gain control such as the noninverting gain amplifier shown in Figure 48.

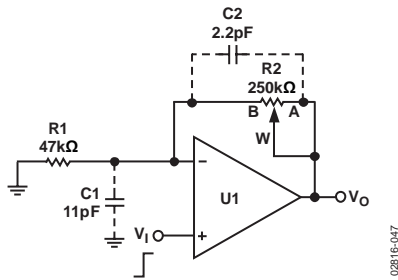

Figure 48. Typical Noninverting Gain Amplifier

When the RDAC B terminal parasitic capacitance is connected to the op amp noninverting node, it introduces a zero for the  $1/\beta_o$  term with 20 dB/dec, whereas a typical op amp gain bandwidth product (GBP) has  $-20$  dB/dec characteristics. A large  $R_2$  and finite  $C_1$  can cause the frequency of this zero to fall well below the crossover frequency. Therefore, the rate of closure becomes 40 dB/dec, and the system has a  $0^\circ$  phase margin at the crossover frequency. If an input is a rectangular pulse or step function, the output can ring or oscillate. Similarly, it is also likely to ring when switching between two gain values; this is equivalent to a stop change at the input.

Depending on the op amp GBP, reducing the feedback resistor might extend the frequency of the zero far enough to overcome the problem. A better approach is to include a compensation capacitor,  $C_2$ , to cancel the effect caused by  $C_1$ . Optimum compensation occurs when  $R_1 \times C_1 = R_2 \times C_2$ . This is not an option because of the variation of  $R_2$ . As a result, one can use the previous relationship and scale  $C_2$  as if  $R_2$  were at its maximum value. Doing this might overcompensate and compromise the performance when  $R_2$  is set at low values.

Alternatively, it avoids the ringing or oscillation at the worst case. For critical applications, find  $C_2$  empirically to suit the oscillation. In general,  $C_2$  in the range of a few picofarads to no more than a few tenths of picofarads is usually adequate for the compensation.

Similarly,  $W$  and  $A$  terminal capacitances are connected to the output (not shown); their effect at this node is less significant and the compensation can be avoided in most cases.

### HIGH VOLTAGE OPERATION

The digital potentiometer can be placed directly in the feedback or input path of an op amp for gain control, provided that the voltage across Terminal A to Terminal B, Terminal W to Terminal A or Terminal W to Terminal B does not exceed  $|5$  V|. When high voltage gain is needed, set a fixed gain in the op amp and let the digital potentiometer control the adjustable input. Figure 49 shows a simple implementation.

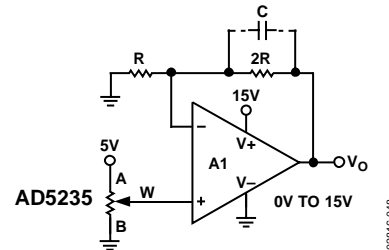

Figure 49. 15 V Voltage Span Control

Similarly, a compensation capacitor,  $C$ , may be needed to dampen the potential ringing when the digital potentiometer changes steps. This effect is prominent when stray capacitance at the inverted node is augmented by a large feedback resistor. Typically, a picofarad Capacitor  $C$  is adequate to combat the problem.

### DAC

For DAC operation (see Figure 50), it is common to buffer the output of the digital potentiometer unless the load is much larger than  $R_{WB}$ . The buffer serves the purpose of impedance conversion and can drive heavier loads.

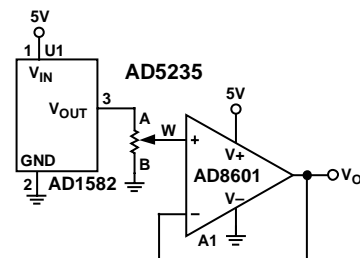

Figure 50. Unipolar 10-Bit DAC



**BIPOLAR PROGRAMMABLE GAIN AMPLIFIER**

For applications requiring bipolar gain, Figure 51 shows one implementation. Digital Potentiometer U1 sets the adjustment range; the wiper voltage ( $V_{W2}$ ) can, therefore, be programmed between  $V_I$  and  $-KV_I$  at a given U2 setting. Configure OP2177 (A2) as a noninverting amplifier that yields a transfer function of

$$\frac{V_O}{V_I} = \left(1 + \frac{R2}{R1}\right) \times \left(\frac{D2}{1024} \times (1 + K) - K\right) \tag{4}$$

where  $K$  is the ratio of  $R_{WB1}/R_{WA1}$  set by U1.



Figure 51. Bipolar Programmable Gain Amplifier

In the simpler (and much more usual) case where  $K = 1$ ,  $V_O$  is simplified to

$$V_O = \left(1 + \frac{R2}{R1}\right) \left(\frac{2D2}{1024} - 1\right) \times V_I \tag{5}$$

Table 21 shows the result of adjusting  $D2$ , with OP2177 (A2) configured as a unity gain, a gain of 2, and a gain of 10. The result is a bipolar amplifier with linearly programmable gain and 1024-step resolution.

**Table 21. Result of Bipolar Gain Amplifier**

D2	R1 = ∞, R2 = 0	R1 = R2	R2 = 9 × R1
0	-1	-2	-10
256	-0.5	-1	-5
512	0	0	0
768	0.5	1	5
1023	0.992	1.984	9.92

**10-BIT BIPOLAR DAC**

If the circuit in Figure 51 is changed with the input taken from a precision reference, U1 is set to midscale, and AD8552 (A2) is configured as a buffer, a 10-bit bipolar DAC can be realized (as shown in Figure 52). Compared to the conventional DAC, this circuit offers comparable resolution but not the precision because of the wiper resistance effects. Degradation of the nonlinearity and temperature coefficient is prominent near the low values of the adjustment range. Alternatively, this circuit offers a unique nonvolatile memory feature that, in some cases, outweighs any shortfalls in precision.

Without consideration of the wiper resistance, the output of this circuit is approximately

$$V_O = \left(\frac{2D2}{1024} - 1\right) \times V_{REF} \tag{6}$$



Figure 52. 10-Bit Bipolar DAC

**PROGRAMMABLE VOLTAGE SOURCE WITH BOOSTED OUTPUT**

For applications that require high current adjustment, such as a laser diode driver or tunable laser, a boosted voltage source can be considered (see Figure 53).

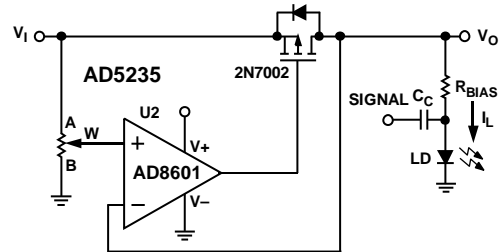

Figure 53. Programmable Booster Voltage Source

In this circuit, the inverting input of the op amp forces  $V_O$  to be equal to the wiper voltage set by the digital potentiometer. The load current is then delivered by the supply via the N-Ch FET  $N_1$  (see Figure 53).  $N_1$  power handling must be adequate to dissipate  $(V_I - V_O) \times I_L$  power. This circuit can source a 100 mA maximum with a 5 V supply.

For precision applications, a voltage reference, such as ADR421, ADR03, or ADR370, can be applied at Terminal A of the digital potentiometer.

**PROGRAMMABLE CURRENT SOURCE**

A programmable current source can be implemented with the circuit shown in Figure 54.



Figure 54. Programmable Current Source

The REF191 is a unique low supply headroom and high current handling precision reference that can deliver 20 mA at 2.048 V. The load current is simply the voltage across Terminal W to Terminal B of the digital potentiometer divided by  $R_S$ .

$$I_L = \frac{V_{REF} \times D}{R_S \times 1024} \tag{7}$$

The circuit is simple but be aware that there are two issues. First, dual-supply op amps are ideal because the ground potential of REF191 can swing from  $-2.048$  V at zero scale to  $V_L$  at full scale of the potentiometer setting. Although the circuit works under single supply, the programmable resolution of the system is reduced by half. Second, the voltage compliance at  $V_L$  is limited to 2.5 V, or equivalently, a 125  $\Omega$  load. When higher voltage compliance is needed, consider digital potentiometers, such as, AD5260, AD5280, and AD7376. Figure 55 shows an alternate circuit for high voltage compliance.

To achieve higher current, such as when driving a high power LED, replace U1 with an LDO, reduce  $R_S$ , and add a resistor in series with the A terminal of the digital potentiometer. This limits the current of the potentiometer and increases the current adjustment resolution.

**PROGRAMMABLE BIDIRECTIONAL CURRENT SOURCE**

For applications that require bidirectional current control or higher voltage compliance, a Howland current pump can be a solution (see Figure 55). If the resistors are matched, the load current is

$$I_L = \frac{R2A + R2B}{R2B} \times V_W \tag{8}$$



Figure 55. Programmable Bidirectional Current Source

$R2B$ , in theory, can be made as small as necessary to achieve the current needed within the A2 output current driving capability. In this circuit, OP2177 delivers  $\pm 5$  mA in either direction, and the voltage compliance approaches 15 V. Without the additions of C1 and C2, the output impedance (looking into  $V_L$ ) can be

$$Z_o = \frac{R1' R2B (R1 + R2A)}{R1 R2' - R1' (R2A + R2B)} \tag{9}$$

$Z_o$  can be infinite, if Resistors  $R1'$  and  $R2'$  match precisely with  $R1$  and  $R2A + R2B$ , respectively, which is desirable. On the other hand, if the resistors do not match,  $Z_o$  can be negative and cause oscillation. As a result, C1, in the range of a few picofarad, is needed to prevent oscillation from the negative impedance.

**PROGRAMMABLE LOW-PASS FILTER**

In analog-to-digital conversions (ADCs), it is common to include an antialiasing filter to band limit the sampling signal. Therefore, the dual-channel AD5235 can be used to construct a second-order Sallen-Key low-pass filter, as shown in Figure 56.



Figure 56. Sallen-Key Low-Pass Filter

The design equations are

$$\frac{V_O}{V_I} = \frac{\omega_f^2}{S^2 + \frac{\omega_f}{Q}S + \omega_f^2} \tag{10}$$

$$\omega_o = \sqrt{\frac{1}{R1 R2 C1 C2}} \tag{11}$$

$$Q = \frac{1}{R1 C1} + \frac{1}{R2 C2} \tag{12}$$

First, users should select convenient values for the capacitors. To achieve maximally flat bandwidth, where  $Q = 0.707$ , let  $C1$  be twice the size of  $C2$  and let  $R1$  equal  $R2$ . As a result, the user can adjust  $R1$  and  $R2$  concurrently to the same setting to achieve the desirable bandwidth.

**PROGRAMMABLE OSCILLATOR**

In a classic Wien bridge oscillator, the Wien network ( $R||C, R'C'$ ) provides positive feedback, whereas  $R1$  and  $R2$  provide negative feedback (see Figure 57).



Figure 57. Programmable Oscillator with Amplitude Control

At the resonant frequency,  $f_o$ , the overall phase shift is zero, and the positive feedback causes the circuit to oscillate. With  $R = R'$ ,  $C = C'$ , and  $R2 = R2A / (R2B + R_{DIODE})$ , the oscillation frequency is

$$\omega_o = \frac{1}{RC} \text{ or } f_o = \frac{1}{2\pi RC} \tag{13}$$

where  $R$  is equal to  $R_{WA}$  such that :

$$R_{WA}(D) = \frac{1024 - D}{1024} \times R_{AB} + R_W \tag{14}$$

At resonance, setting  $R2/R1 = 2$  balances the bridge. In practice,  $R2/R1$  should be set slightly larger than 2 to ensure that the oscillation can start. On the other hand, the alternate turn-on of the diodes,  $D1$  and  $D2$ , ensures that  $R2/R1$  is smaller than 2, momentarily stabilizing the oscillation.

When the frequency is set, the oscillation amplitude can be turned by  $R2B$  because

$$\frac{2}{3}V_O = I_D R2B + V_D \tag{15}$$

$V_O$ ,  $I_D$ , and  $V_D$  are interdependent variables. With proper selection of  $R2B$ , an equilibrium is reached such that  $V_O$  converges.  $R2B$  can be in series with a discrete resistor to increase the amplitude, but the total resistance cannot be too large to saturate the output.

In Figure 56 and Figure 57, the frequency tuning requires that both RDACs be adjusted concurrently to the same settings. Because the two channels might be adjusted one at a time, an intermediate state occurs that might not be acceptable for some applications. Of course, the increment/decrement instructions (Instruction 5, Instruction 7, Instruction 13, and Instruction 15) can all be used. Different devices can also be used in daisy-chain mode so that parts can be programmed to the same settings simultaneously.

**OPTICAL TRANSMITTER CALIBRATION WITH ADN2841**

The AD5235, together with the multirate 2.7 Gbps laser diode driver, ADN2841, forms an optical supervisory system in which the dual digital potentiometers can be used to set the laser average optical power and extinction ratio (see Figure 58). The AD5235 is particularly suited for the optical parameter settings because of its high resolution and superior temperature coefficient characteristics.

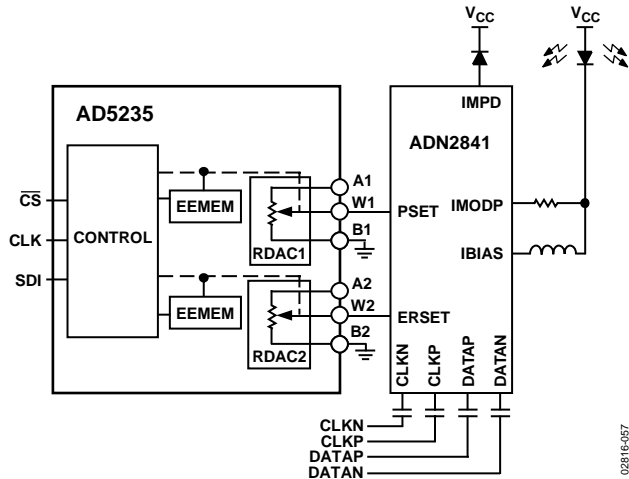

Figure 58. Optical Supervisory System

The ADN2841 is a 2.7 Gbps laser diode driver that uses a unique control algorithm to manage the average power and extinction ratio of the laser after its initial factory calibration. The ADN2841 stabilizes the data transmission of the laser by continuously monitoring its optical power and correcting the variations caused by temperature and the degradation of the laser over time. In the ADN2841, the IMPD monitors the laser diode current. Through its dual-loop power and extinction ratio control calibrated by the dual RDACs of the AD5235, the internal driver controls the bias current, IBIAS, and consequently the average power. It also regulates the modulation current, IMODP, by changing the modulation current linearly with slope efficiency. Therefore, any changes in the laser threshold current or slope efficiency are compensated for. As a result, the optical supervisory system minimizes the laser characterization efforts and, therefore, enables designers to apply comparable lasers from multiple sources.

**RESISTANCE SCALING**

The AD5235 offers 25 kΩ or 250 kΩ nominal resistance. When users need lower resistance but must maintain the number of adjustment steps, they can parallel multiple devices. For example, Figure 59 shows a simple scheme of paralleling two channels of RDACs. To adjust half the resistance linearly per step, program both RDACs concurrently with the same settings.



Figure 59. Reduce Resistance by Half with Linear Adjustment Characteristics

In voltage divider mode, by paralleling a discrete resistor, as shown in Figure 60, a proportionately lower voltage appears at Terminal A to Terminal B. This translates into a finer degree of precision because the step size at Terminal W is smaller. The voltage can be found as

$$V_W(D) = \frac{(R_{AB} // R2)}{R3 + R_{AB} // R2} \times \frac{D}{1024} \times V_{DD} \tag{16}$$



Figure 60. Lowering the Nominal Resistance

Figure 59 and Figure 60 show that the digital potentiometers change steps linearly. Alternatively, pseudo log taper adjustment is usually preferred in applications such as audio control. Figure 61 shows another type of resistance scaling. In this configuration, the smaller the R2 with respect to R<sub>AB</sub>, the more the pseudo log taper characteristic of the circuit behaves.



Figure 61. Resistor Scaling with Pseudo Log Adjustment Characteristics

The equation is approximated as

$$R_{EQUIVALENT} = \frac{D \times R_{AB} + 51,200}{D \times R_{AB} + 51,200 + 1024 \times R} \tag{17}$$

Users should also be aware of the need for tolerance matching as well as for temperature coefficient matching of the components.

**RESISTANCE TOLERANCE, DRIFT, AND TEMPERATURE COEFFICIENT MISMATCH CONSIDERATIONS**

In rheostat mode operation, such as gain control, the tolerance mismatch between the digital potentiometer and the discrete resistor can cause repeatability issues among various systems (see Figure 62). Because of the inherent matching of the silicon process, it is practical to apply the dual-channel device in this type of application. As such, R1 can be replaced by one of the channels of the digital potentiometer and programmed to a specific value. R2 can be used for the adjustable gain. Although it adds cost, this approach minimizes the tolerance and temperature coefficient mismatch between R1 and R2. This approach also tracks the resistance drift over time. As a result, these less than ideal parameters become less sensitive to system variations.

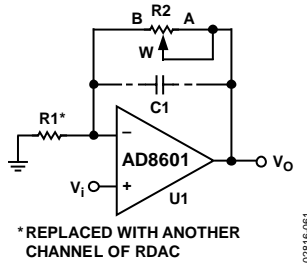

Figure 62. Linear Gain Control with Tracking Resistance Tolerance, Drift, and Temperature Coefficient

Note that the circuit in Figure 63 can track tolerance, temperature coefficient, and drift in this particular application. The characteristic of the transfer function is, however, a pseudo log rather than a linear gain function.



Figure 63. Nonlinear Gain Control with Tracking Resistance Tolerance and Drift

**RDAC CIRCUIT SIMULATION MODEL**

The internal parasitic capacitances and the external capacitive loads dominate the ac characteristics of the RDACs. Configured as a potentiometer divider, the -3 dB bandwidth of the AD5235 (25 kΩ resistor) measures 125 kHz at half scale. Figure 17 provides the large signal bode plot characteristics of the two available resistor versions, 25 kΩ and 250 kΩ. A parasitic simulation model is shown in Figure 64.



Figure 64. RDAC Circuit Simulation Model (RDAC = 25 kΩ)

The following code provides a macro model net list for the 25 kΩ RDAC:

```
.PARAM D = 1024, RDAC = 25E3
*
.SUBCKT DPOT (A, W, B)
*
CA A 0 11E-12
RWA A W {(1-D/1024)* RDAC + 30}
CW W 0 80E-12
RWB W B {D/1024 * RDAC + 30}
CB B 0 11E-12
*
.ENDS DPOT
```

OUTLINE DIMENSIONS



COMPLIANT TO JEDEC STANDARDS MO-153-AB

Figure 65. 16-Lead Thin Shrink Small Outline Package [TSSOP] (RU-16)  
Dimensions shown in millimeters

ORDERING GUIDE

Model <sup>1, 2</sup>	R <sub>AB</sub> (kΩ)	Temperature Range	Package Description	Package Option	Ordering Quantity	Branding <sup>3</sup>
AD5235BRUZ25	25	-40°C to +85°C	16-Lead TSSOP	RU-16	96	5235B25
AD5235BRUZ25-RL7	25	-40°C to +85°C	16-Lead TSSOP	RU-16	1,000	5235B25
AD5235BRUZ250	250	-40°C to +85°C	16-Lead TSSOP	RU-16	96	5235B250
AD5235BRUZ250-R7	250	-40°C to +85°C	16-Lead TSSOP	RU-16	1,000	5235B250
EVAL-AD5235SDZ			Evaluation Board		1	

<sup>1</sup> Z = RoHS Compliant Part.

<sup>2</sup> The evaluation board is shipped with the 25 kΩ R<sub>AB</sub> resistor option; however, the board is compatible with all available resistor value options.

<sup>3</sup> Line 1 contains the ADI logo followed by the date code, YYWW. Line 2 contains the model number followed by the end-to-end resistance value (note: D = 250 kΩ).  
—OR—

Line 1 contains the model number. Line 2 contains the ADI logo followed by the end-to-end resistance value. Line 3 contains the date code, YYWW.

**NOTES**

**NOTES**



## Данный компонент на территории Российской Федерации

### Вы можете приобрести в компании MosChip.

Для оперативного оформления запроса Вам необходимо перейти по данной ссылке:

<http://moschip.ru/get-element>

Вы можете разместить у нас заказ для любого Вашего проекта, будь то серийное производство или разработка единичного прибора.

В нашем ассортименте представлены ведущие мировые производители активных и пассивных электронных компонентов.

Нашей специализацией является поставка электронной компонентной базы двойного назначения, продукции таких производителей как XILINX, Intel (ex.ALTERA), Vicor, Microchip, Texas Instruments, Analog Devices, Mini-Circuits, Amphenol, Glenair.

Сотрудничество с глобальными дистрибьюторами электронных компонентов, предоставляет возможность заказывать и получать с международных складов практически любой перечень компонентов в оптимальные для Вас сроки.

На всех этапах разработки и производства наши партнеры могут получить квалифицированную поддержку опытных инженеров.

Система менеджмента качества компании отвечает требованиям в соответствии с ГОСТ Р ИСО 9001, ГОСТ РВ 0015-002 и ЭС РД 009

### Офис по работе с юридическими лицами:

105318, г.Москва, ул.Щербаковская д.3, офис 1107, 1118, ДЦ «Щербаковский»

Телефон: +7 495 668-12-70 (многоканальный)

Факс: +7 495 668-12-70 (доб.304)

E-mail: [info@moschip.ru](mailto:info@moschip.ru)

Skype отдела продаж:

moschip.ru

moschip.ru\_4

moschip.ru\_6

moschip.ru\_9