



## Surround Audio Processor for Mobile Applications

### ■ GENERAL DESCRIPTION

The **NJM2705** is the surround audio processor for mobile applications.

It regenerates the 3D surround sound with extremely narrow space two speakers (2SP mode), headphone surround with normal headphone (HP mode) and reverberation sound with only one speaker (1SP mode).

It includes mode control switches for surround function and standby function and realizes low consumption power design by standby function.

It is suitable for PDA and portable game.

### ■ PACKAGE OUTLINE

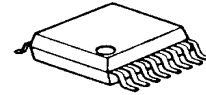

**NJM2705V**

### ■ FEATURES

- Operating Voltage 1.8 to 6V
- Operating Current 0.7mA typ. at Active mode  
1μA max. at Standby mode
- Low Output Noise 10μVrms typ  
(2SP/HP/1SP mode, VR : max.)
- Variable Surround Effect by external resistor  
(Adjustable for speaker and headphone independently.)
- Standby Function
- Internal Mode Control Switch
- Bipolar Technology
- Package Outline SSOP16

### ■ BLOCK DIAGRAM

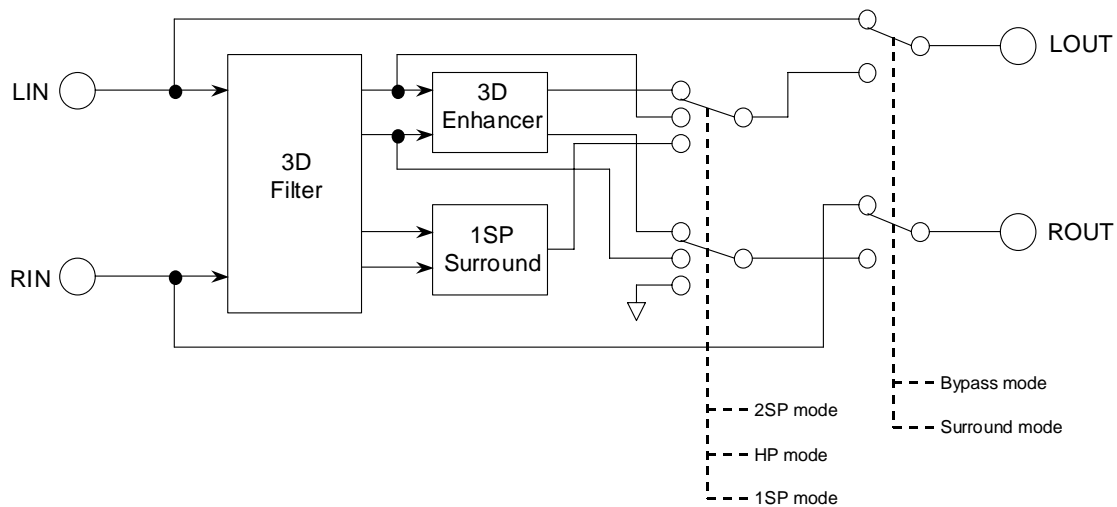

# NJM2705

## ■ PIN CONFIGURATION

SSOP16 (Top View)

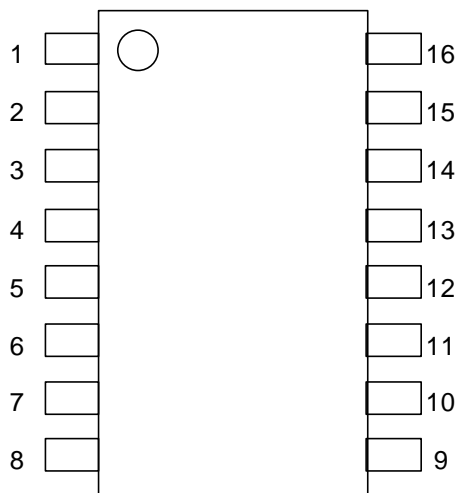

- |          |           |
|----------|-----------|
| 1. NFHPR | 9. V+     |
| 2. NFSPR | 10. STBY  |
| 3. ROUT  | 11. SW1   |
| 4. LOUT  | 12. SW2   |
| 5. RIN   | 13. PS    |
| 6. LIN   | 14. LMON  |
| 7. VREF  | 15. NFHPL |
| 8. GND   | 16. NFSPL |

## ■ABSOLUTE MAXIMUM RATING (Ta=25°C)

PARAMETER	SYMBOL	RATINGS	UNIT
Supply Voltage	V <sup>+</sup>	7	V
Power Dissipation	P <sub>D</sub>	300	mW
Operating Temperature Range	T <sub>opr</sub>	-20 to +75	°C
Storage Temperature Range	T <sub>stg</sub>	-40 to +125	°C

## ■OPERATING VOLTAGE

PARAMETER	SYMBOL	TEST CONDITION	MIN	TYP	MAX	UNIT
Operating Voltage	V <sup>+</sup>	-	1.8	3.0	6.0	V

## ■ELECTRICAL CHARACTERISTICS (V<sup>+</sup>=3V, Ta=25°C unless otherwise specified)

PARAMETER	SYMBOL	TEST CONDITION	TEST CONDITION						MIN	TYP	MAX	UNIT
			INPUT		OUT PUT	MODE	SP VR	HP VR				
			L	R								
Operating Current	I <sub>cc</sub>	No Signal	0	0	-	Active			-	450	700	μA
			0	0	-	Standby			-	0.1	1.0	
Reference Voltage	V <sub>ref</sub>	No Signal	0	0	-	-			1.0	1.15	1.3	V

## ●AC CHARACTERISTICS

(V<sup>+</sup>=3V, Ta=25°C, V<sub>IN</sub>=-20dBV(100mVrms), f=1kHz, R<sub>L</sub>=10kΩ, unless otherwise specified)

PARAMETER	SYMBOL	TEST CONDITION	TEST CONDITION						MIN	TYP	MAX	UNIT
			INPUT		OUT PUT	MODE	SP VR	HP VR				
			L	R								
Maximum Input Voltage	V <sub>IM1</sub>	f=1kHz THD=1%	V <sub>IN</sub> 0	0 V <sub>IN</sub>	L R	Bypass	- -	- -	-2.0 (790)	-	dBV (mVrms)	
	V <sub>IM2</sub>	f=100Hz THD=1%	V <sub>IN</sub> 0	0 V <sub>IN</sub>	L R	2SP	MAX -	- -	-16.0 (160)	-		
	V <sub>IM3</sub>	f=100Hz THD=1%	V <sub>IN</sub> 0	0 V <sub>IN</sub>	L R	HP	- MAX	- -	-16.0 (160)	-		
	V <sub>IM4</sub>	f=100Hz THD=1%	V <sub>IN</sub>	0	L	1SP	MAX -	- -	-16.0 (160)	-		
	V <sub>IM5</sub>	f=100Hz THD=1%	0	V <sub>IN</sub>	L	1SP	MAX -	- -	-14.5 (190)	-		
	V <sub>IM6</sub>	V <sup>+</sup> =1.8V, f=1kHz THD=1%	V <sub>IN</sub> 0	0 V <sub>IN</sub>	L R	Bypass	- -	-10.5 (300)	-8.5 (380)	-		
	V <sub>IM7</sub>	V <sup>+</sup> =1.8V, f=100Hz THD=1%	V <sub>IN</sub> 0	0 V <sub>IN</sub>	L R	2SP	MAX -	-24.5 (60)	-22.5 (75)	-		
	V <sub>IM8</sub>	V <sup>+</sup> =1.8V, f=100Hz THD=1%	V <sub>IN</sub> 0	0 V <sub>IN</sub>	L R	HP	- MAX	-24.5 (60)	-22.5 (75)	-		
	V <sub>IM9</sub>	V <sup>+</sup> =1.8V, f=100Hz THD=1%	V <sub>IN</sub>	0	L	1SP	MAX -	-24.5 (60)	-22.5 (75)	-		
	V <sub>IM10</sub>	V <sup>+</sup> =1.8V, f=100Hz THD=1%	0	V <sub>IN</sub>	L	1SP	MAX -	-23.0 (70)	-21.0 (90)	-		
Output Noise	V <sub>NO1</sub>	R <sub>g</sub> =∞ A-Weighted	0	0	L R	Bypass	- -	- -	-112 (25)	-106 (50)	dBV (μVrms)	
	V <sub>NO2</sub>	R <sub>g</sub> =∞ A-Weighted	0	0	L R	1SP	MAX -	- -	-100 (10)	-94 (20)		
	V <sub>NO3</sub>	R <sub>g</sub> =∞ A-Weighted	0	0	L R	HP	- MAX	- -	-100 (10)	-94 (20)		
	V <sub>NO4</sub>	R <sub>g</sub> =∞ A-Weighted	0	0	L	1SP	MAX -	- -	-100 (10)	-94 (20)		

# NJM2705

## ● AC CHARACTERISTICS

( $V^+=3V$ ,  $T_a=25^\circ C$ ,  $V_{IN}=-20dBV(100mVrms)$ ,  $f=1kHz$ ,  $R_L=10k\Omega$ , unless otherwise specified)

PARAMETER	SYMBOL	TEST CONDITION							MIN	TYP	MAX	UNIT
		INPUT		OUT PUT	MODE	SP VR	HP VR					
		L	R									
Total Harmonic Distortion	THD1	f=1kHz	$V_{IN}$ 0	0 $V_{IN}$	L R	Bypass	-	-	-	0.02	0.05	%
	THD2	f=1kHz	$V_{IN}$ 0	0 $V_{IN}$	L R	2SP	MAX	-	-	0.1	0.5	
	THD3	f=1kHz	$V_{IN}$ 0	0 $V_{IN}$	L R	HP	-	MAX	-	0.1	0.5	
	THD4	f=1kHz	$V_{IN}$ 0	0 $V_{IN}$	L R	1SP	MAX	-	-	0.1	0.5	
BYPASS Gain	$G_{VBYP}$	f=1kHz	$V_{IN}$ 0	0 $V_{IN}$	L R	Bypass	-	-	-1.0	0.0	1.0	dB
Surround Gain	$G_{VSUR1}$	f=100Hz	$V_{IN}$ 0	0 $V_{IN}$	L R	2SP	MAX	-	12.5	14.5	16.5	dB
	$G_{VSUR2}$	f=100Hz	$V_{IN}$ 0	0 $V_{IN}$	L R	2SP	MIN	-	0.5	2.5	4.5	
	$G_{VSUR3}$	f=100Hz	$V_{IN}$ 0	0 $V_{IN}$	L R	HP	-	MAX	12.5	14.5	16.5	
	$G_{VSUR4}$	f=100Hz	$V_{IN}$ 0	0 $V_{IN}$	L R	HP	-	MIN	0.5	2.5	4.5	
	$G_{VSUR5}$	f=100Hz	$V_{IN}$	0	L	1SP	MAX	-	6.5	8.5	10.5	
	$G_{VSUR6}$	f=100Hz	0	$V_{IN}$	L	1SP	MAX	-	2.0	4.0	6.0	
	$G_{VSUR7}$	f=100Hz	$V_{IN}$	0	L	1SP	MIN	-	-5.5	-3.5	-1.5	
	$G_{VSUR8}$	f=100Hz	0	$V_{IN}$	L	1SP	MIN	-	-12.0	-10.0	-8.0	

## ● CONTROL CHARACTERISTICS ( $V^+=3V$ , $T_a=25^\circ C$ unless otherwise specified)

PARAMETER	SYMBOL	TEST CONDITION	MIN	TYP	MAX	UNIT
MODE Select Control Voltage	$V_{MODE}$	$V_{IN}$ =High Level	1.2	-	$V^+$	V
		$V_{IN}$ =Low Level	0.0	-	0.3	

## ■ SWITCH FUNCTION

### SURROUND FUNCTION SW

MODE	SW1	SW2	NOTES
Bypass	L, OPEN	L, OPEN	Input Through
2SP mode	L, OPEN	H	Surround mode for narrow space two speakers
HP mode	H	L, OPEN	Surround mode for Headphone
1SP mode	H	H	Surround mode for monaural speaker (Surround signal from LOUT)

### STANDBY SW

MODE	STBY	NOTES
Standby	L, open	IC is non-active
Active	H	IC is active

## TERMINAL DESCRIPTION

PIN No.	SYMBOL	FUNCTION	EQUIVALENT CIRCUIT	Voltage
5 6	LIN RIN	Lch Input Rch Input		1.15V
4 3 14	LOUT ROUT LMON	Lch Output Rch Output Filter terminal		1.15V
2 1 16 15	NFSPR NFHPR NFSPL NFHPL	Filter terminal Filter terminal Filter terminal Filter terminal		1.15V
13	PS	Filter terminal		1.15V

# NJM2705

## ■ TERMINAL DESCRIPTION

PIN No.	SYMBOL	FUNCTION	EQUIVALENT CIRCUIT	Voltage
12 11	SW2 SW1	Mode control switch Mode control switch		0V
10	STBY	Standby switch		0V
9	V+	Power Supply	—	V+
8	GND	GND	—	0V
7	VREF	Reference voltage		1.15V

## APPLICATION CIRCUIT

### 1) 2SP mode, HP mode

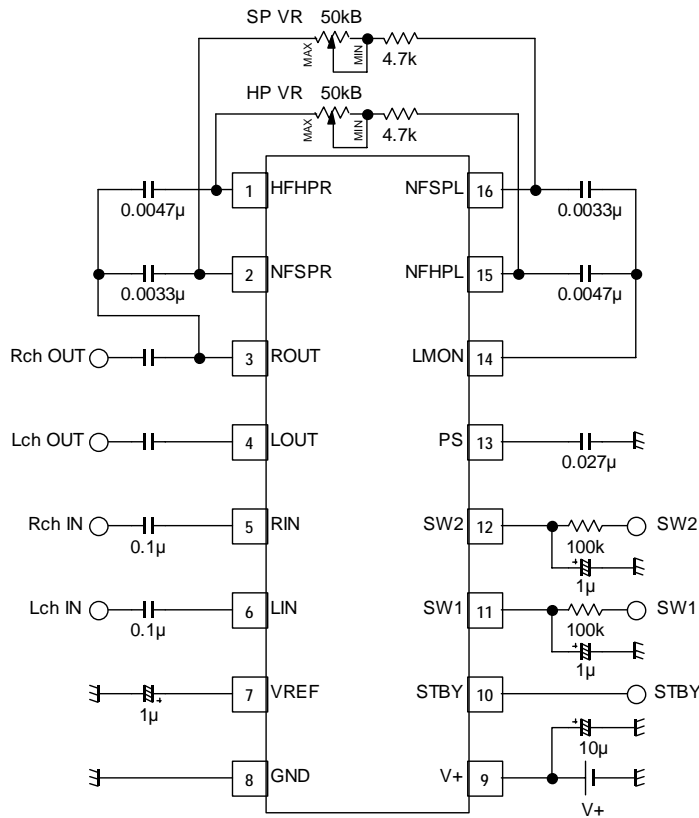

### 2) 1SP mode, HP mode

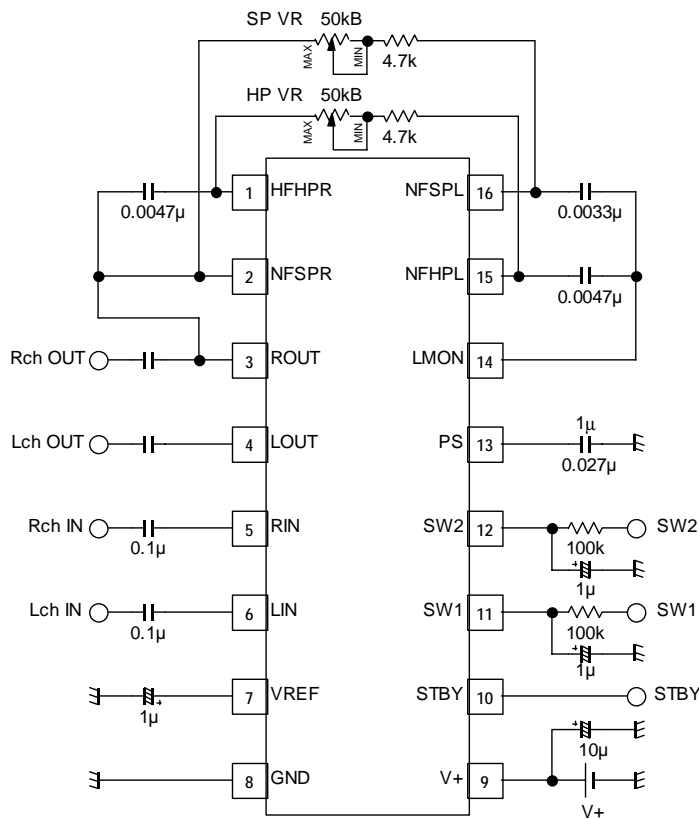

Surround signal is outputted from LOUT terminal at 1SP mode.

## TYPICAL CHARACTERISTICS

Operating Current vs. Operating Voltage (STANDBY)

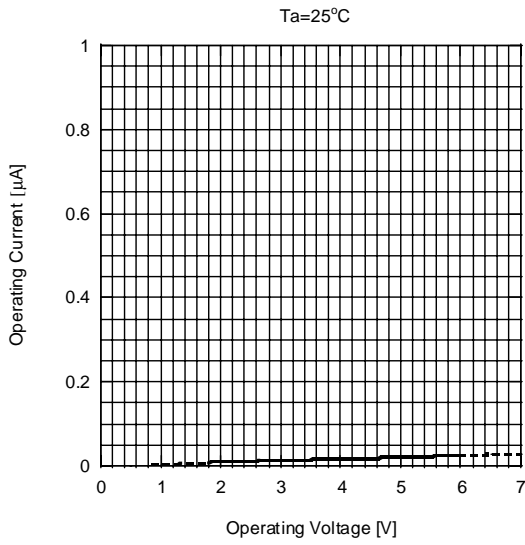

Operating Current vs. Temperature (STANDBY)

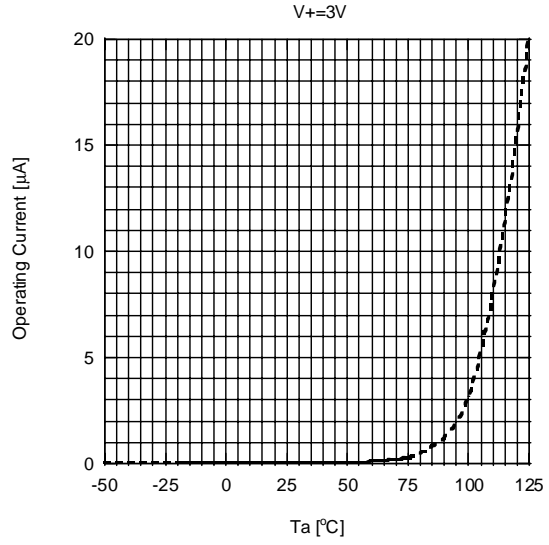

Operating Current vs. Operating Voltage (ACTIVE)

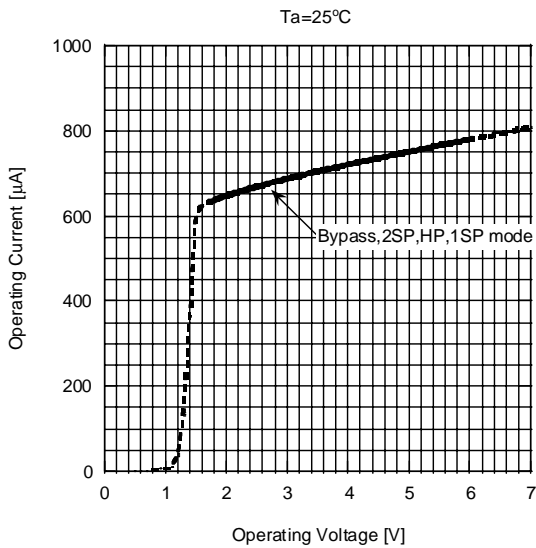

Operating Current vs. Temperature (ACTIVE)

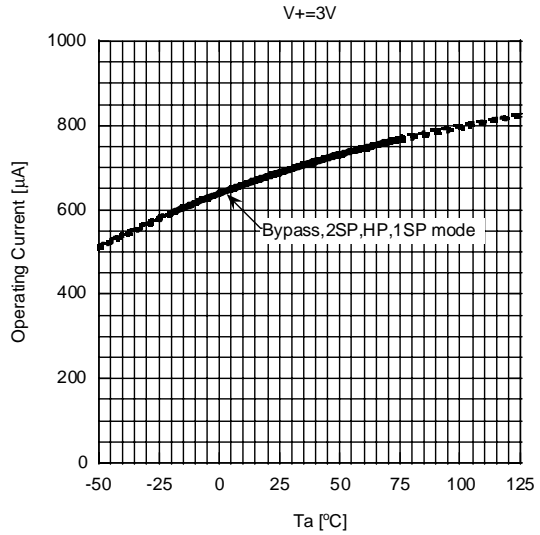

Reference Voltage vs. Operating Voltage

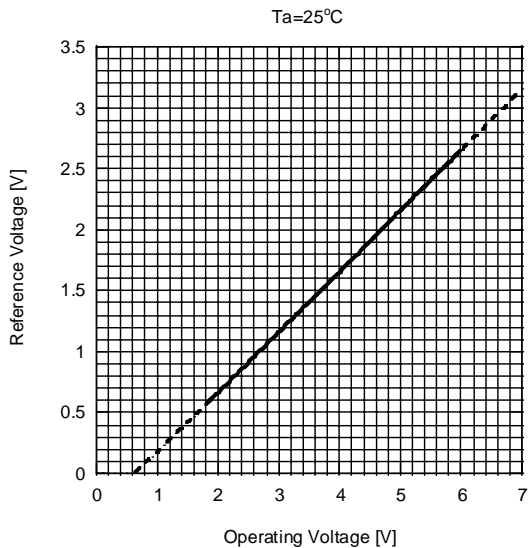

Reference Voltage vs. Temperature

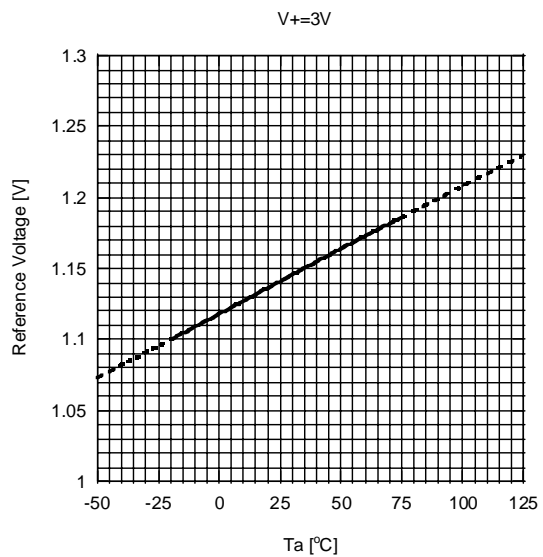



## TYPICAL CHARACTERISTICS

**Maximum Input Voltage vs. Operating Voltage (BYPASS)**

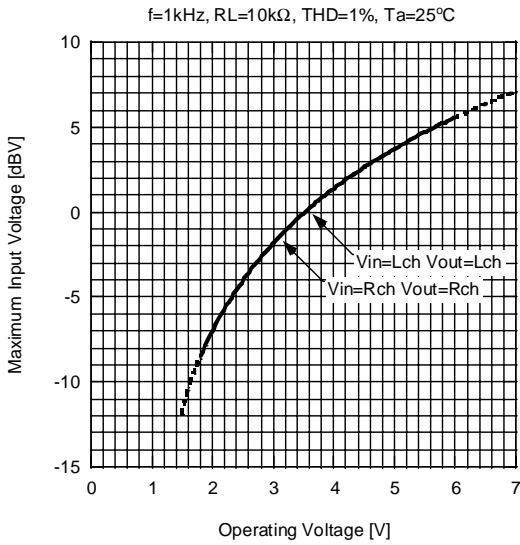

**Maximum Input Voltage vs. Operating Voltage (2SP)**

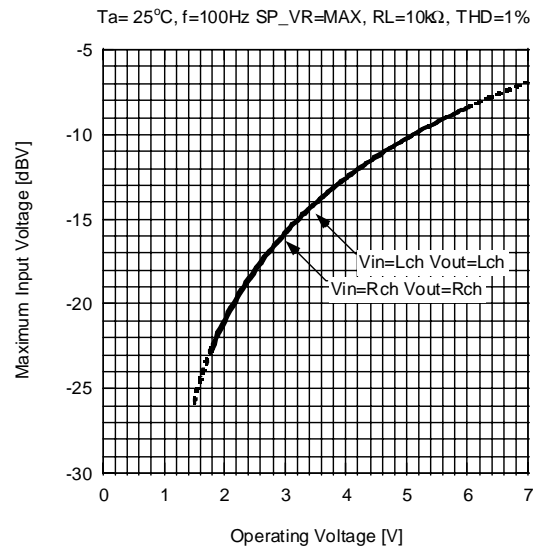

**Maximum Input Voltage vs. Operating Voltage (HP)**

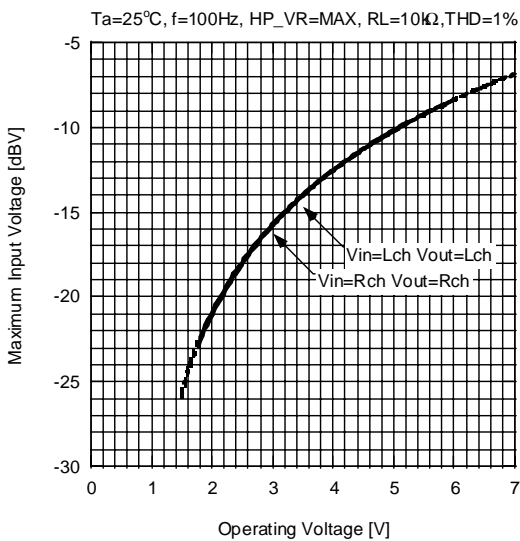

**Maximum Input Voltage vs. Temperature (1SP)**

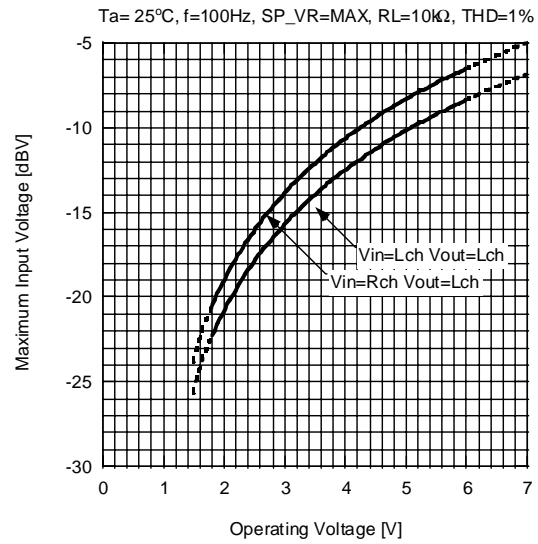

**Maximum Input Voltage vs. Temperature (BYPASS)**

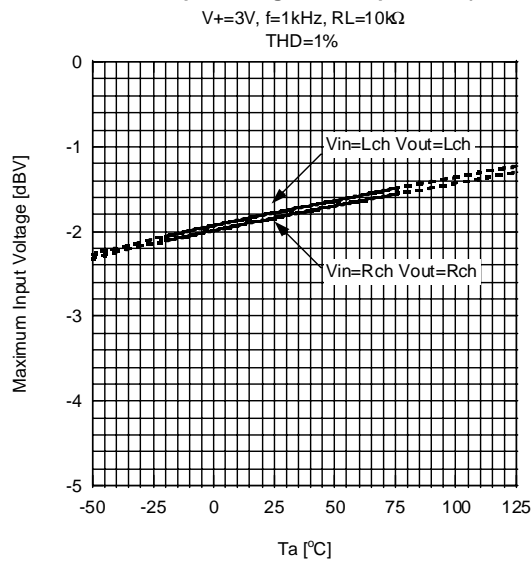

**Maximum Input Voltage vs. Temperature (2SP)**

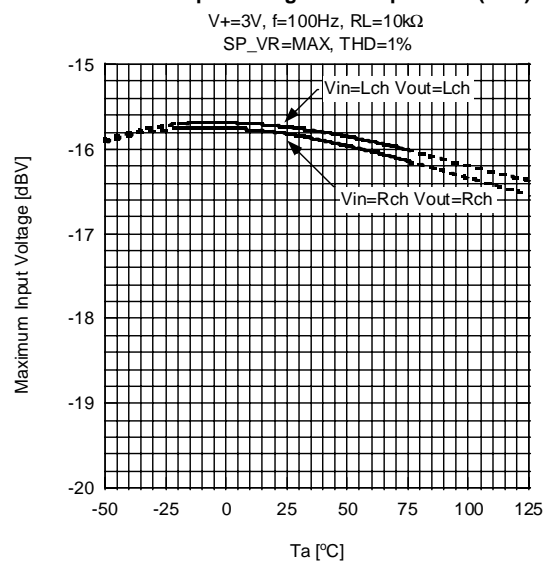

## TYPICAL CHARACTERISTICS

**Maximum Input Voltage vs. Temperature (HP)**

V+=3V, f=100Hz, RL=10kΩ  
HP\_VR=MAX, THD=1%

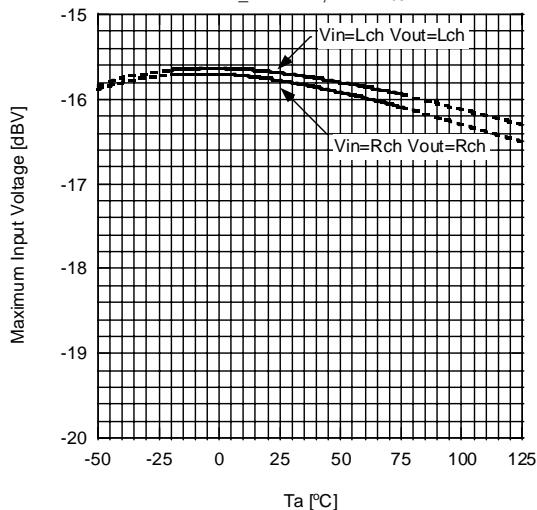

**Maximum Input Voltage vs. Temperature (1SP)**

V+=3V, f=100Hz, RL=10kΩ  
SP\_VR=MAX, THD=1%

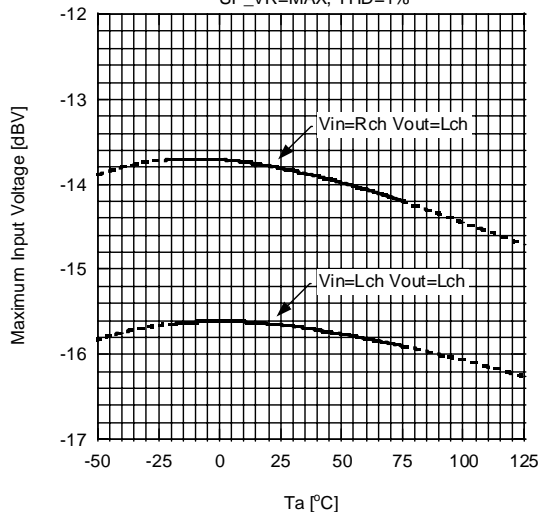

**Output Noise Voltage vs. Temperature**

V+=3V, Rg=0Ω, Vout=Lch  
SP\_VR=MAX, HP\_VR=MAX, FILTER=A-Weighted

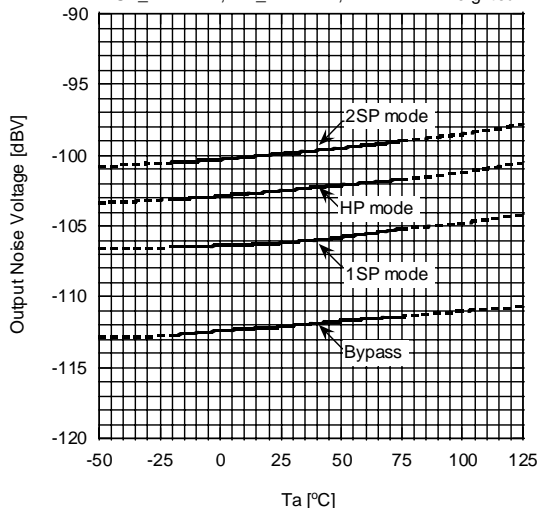

**Output Noise Voltage vs. Temperature**

V+=3V, Rg=0Ω, Vout=Rch  
SP\_VR=MAX, HP\_VR=MAX, FILTER=A-Weighted

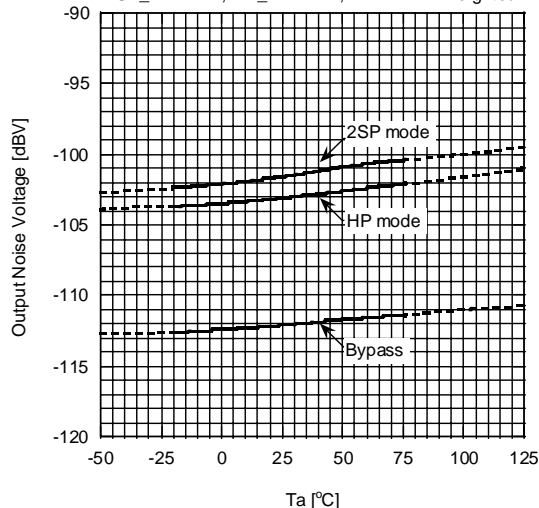

**Total Harmonic Distortion vs. Input Voltage (BYPASS)**

V+=3V, Vin=Lch, f=1kHz, Vout=Lch  
RL=10kΩ, BW=10Hz-80kHz

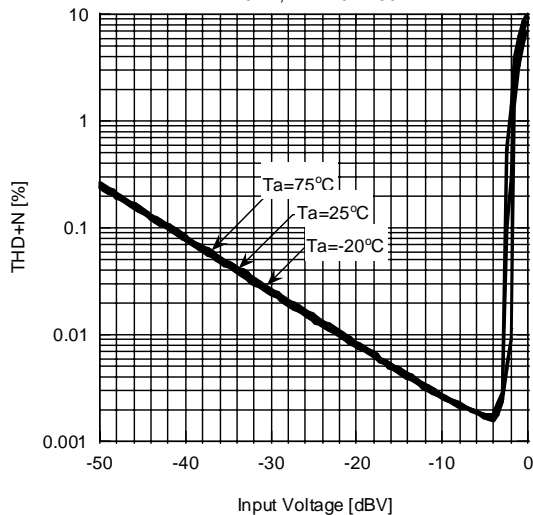

**Total Harmonic Distortion vs. Input Voltage (2SP)**

V+=3V, Vin=Lch, f=100Hz, Vout=Lch  
RL=10kΩ, BW=10Hz-80kHz, SP\_VR=MAX

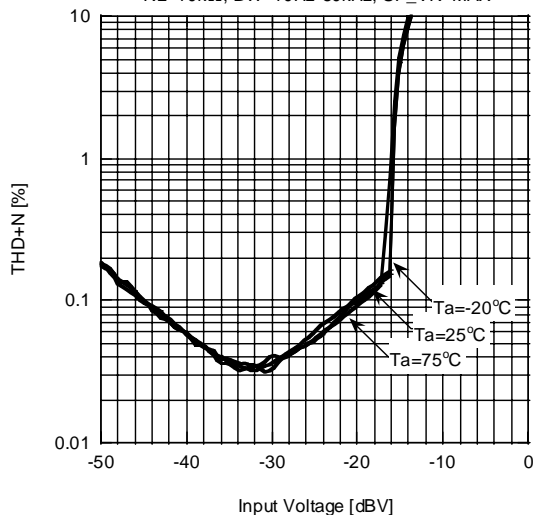

## TYPICAL CHARACTERISTICS

**Total Harmonic Distortion vs. Input Voltage (HP)**

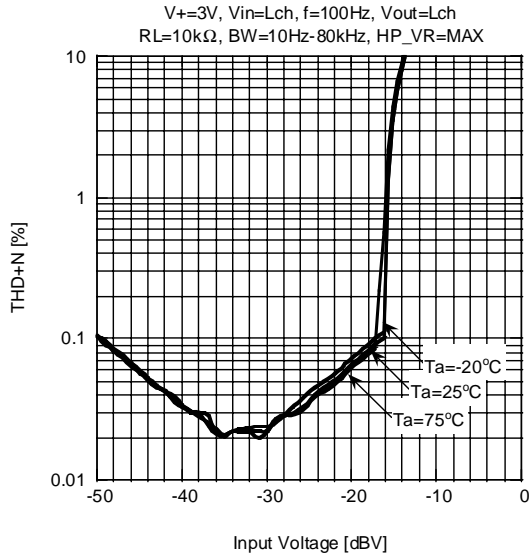

**Total Harmonic Distortion vs. Input Voltage (1SP)**

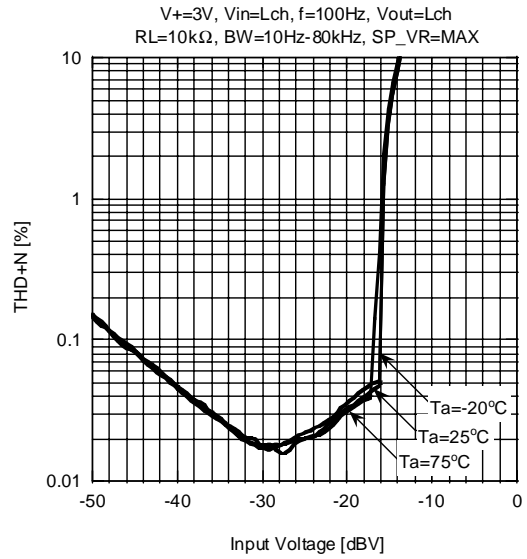

**Frequency Response (BYPASS)**

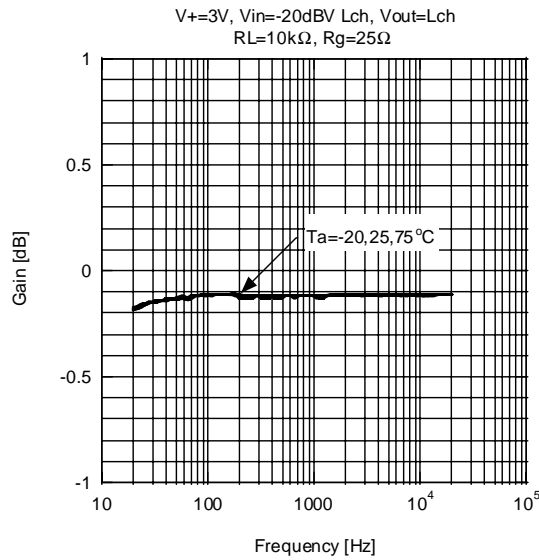

**Frequency Response (2SP)**

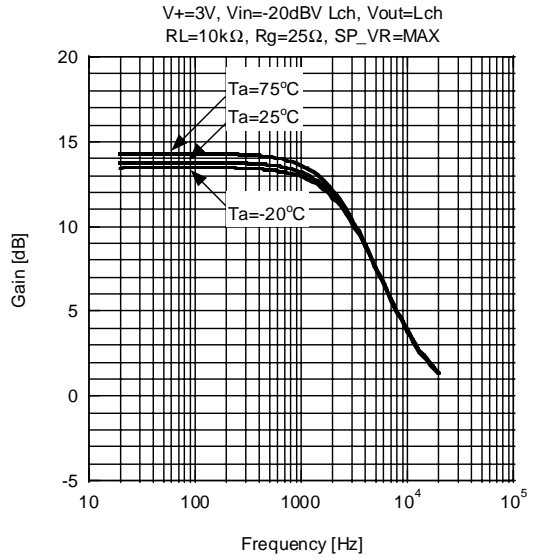

**Frequency Response (2SP)**

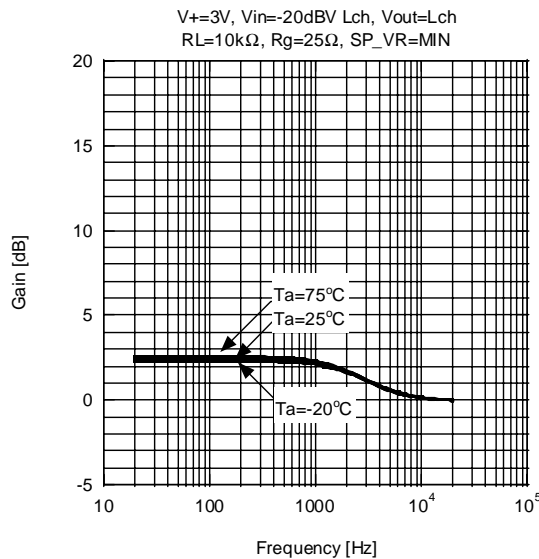

**Phase vs. Frequency (2SP)**

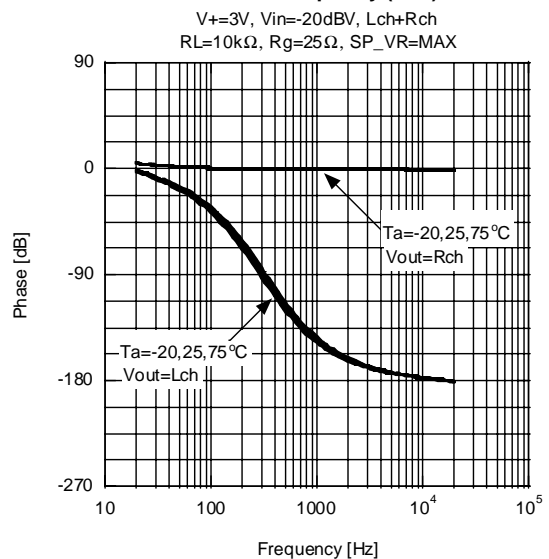

## TYPICAL CHARACTERISTICS

**Frequency Response (HP)**

V+=3V, Vin=-20dBV Lch, Vout=Lch  
RL=10kΩ, Rg=25Ω, HP\_VR=MAX

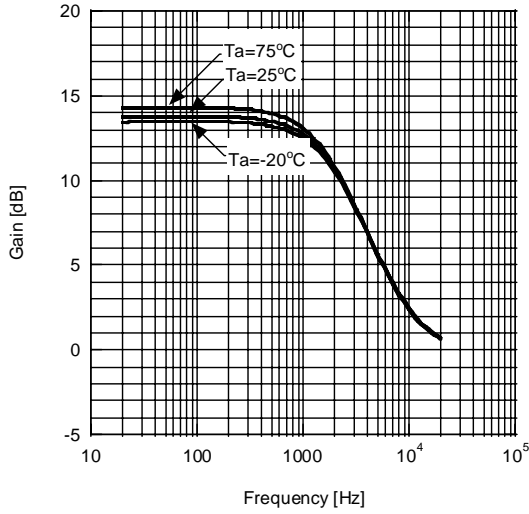

**Frequency Response (HP)**

V+=3V, Vin=-20dBV Lch, Vout=Lch  
RL=10kΩ, Rg=25Ω, HP\_VR=MIN

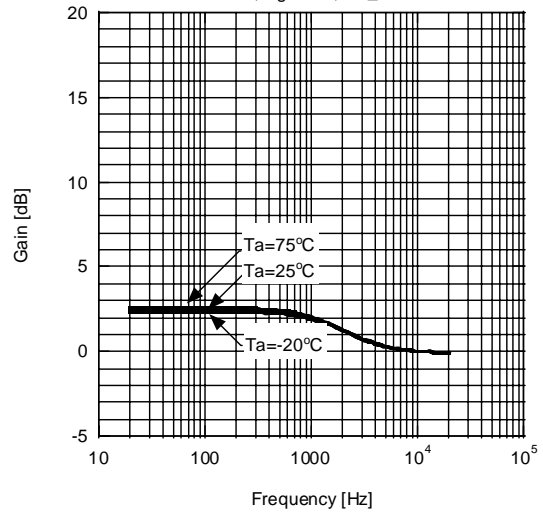

**Frequency Response (1SP)**

V+=3V, Vin=-20dBV, Vout=Lch  
RL=10kΩ, Rg=25Ω, SP\_VR=MAX

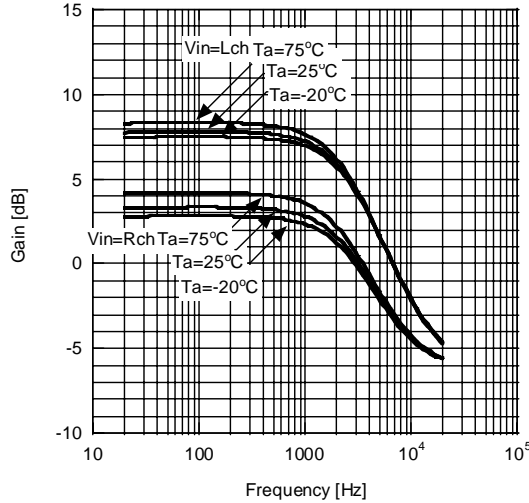

**Frequency Response (1SP)**

V+=3V, Vin=-20dBV, Vout=Lch  
RL=10kΩ, Rg=25Ω, VR=MIN

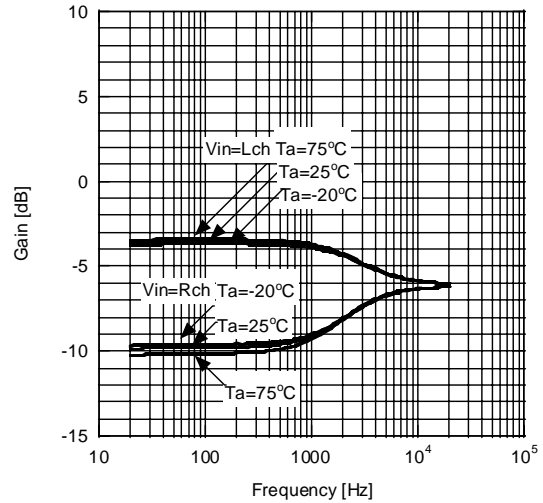

**[CAUTION]**

The specifications on this databook are only given for information, without any guarantee as regards either mistakes or omissions. The application circuits in this databook are described only to show representative usages of the product and not intended for the guarantee or permission of any right including the industrial rights.

# Mouser Electronics

Authorized Distributor

Click to View Pricing, Inventory, Delivery & Lifecycle Information:

[NJR:](#)

[NJM2705SD3-TE1](#) [NJM2705V-TE2](#)

## Данный компонент на территории Российской Федерации

### Вы можете приобрести в компании MosChip.

Для оперативного оформления запроса Вам необходимо перейти по данной ссылке:

<http://moschip.ru/get-element>

Вы можете разместить у нас заказ для любого Вашего проекта, будь то серийное производство или разработка единичного прибора.

В нашем ассортименте представлены ведущие мировые производители активных и пассивных электронных компонентов.

Нашей специализацией является поставка электронной компонентной базы двойного назначения, продукции таких производителей как XILINX, Intel (ex.ALTERA), Vicor, Microchip, Texas Instruments, Analog Devices, Mini-Circuits, Amphenol, Glenair.

Сотрудничество с глобальными дистрибьюторами электронных компонентов, предоставляет возможность заказывать и получать с международных складов практически любой перечень компонентов в оптимальные для Вас сроки.

На всех этапах разработки и производства наши партнеры могут получить квалифицированную поддержку опытных инженеров.

Система менеджмента качества компании отвечает требованиям в соответствии с ГОСТ Р ИСО 9001, ГОСТ РВ 0015-002 и ЭС РД 009

### Офис по работе с юридическими лицами:

105318, г.Москва, ул.Щербаковская д.3, офис 1107, 1118, ДЦ «Щербаковский»

Телефон: +7 495 668-12-70 (многоканальный)

Факс: +7 495 668-12-70 (доб.304)

E-mail: [info@moschip.ru](mailto:info@moschip.ru)

Skype отдела продаж:

moschip.ru

moschip.ru\_4

moschip.ru\_6

moschip.ru\_9