

SIOV metal oxide varistors

Strap varistors, HighE, AdvanceD, LS41 series

Series/Type: B722*

Date: January 2018

© EPCOS AG 2018. Reproduction, publication and dissemination of this publication, enclosures hereto and the information contained therein without EPCOS' prior express consent is prohibited.

EPCOS AG is a TDK Group Company.

Construction

- Rectangular varistor element
- Coating: epoxy resin, flame-retardant to UL 94 V-0
- Bolt-holed strap terminals for screw fixing or soldering
- Bent or straight strap terminals

Features

- Dimensions equivalent to SIOV-LS40
- High surge current up to 50 kA
- Wide operating voltage range 130 ... 460 V_{RMS}
- Designed in accordance with the requirements of IEC 61643-1, class II, for low-voltage surge protection devices

Approvals

- UL
- CSA

Delivery mode

- Vacuum-packed styrofoam box

General technical data

| | | | |
|-----------------------|----------------|--------------|-------------------|
| Climatic category | to IEC 60068-1 | 40/85/56 | |
| Operating temperature | to CECC 42000 | -25 ... + 85 | °C |
| Storage temperature | | -25 ... +110 | °C |
| Electric strength | to CECC 42 000 | ≥ 2.5 | kV _{RMS} |
| Insulation resistance | to CECC 42 000 | ≥ 10 | MΩ |

Electrical specifications and ordering codes
Maximum ratings ($T_A = 85\text{ °C}$)

| Ordering code | Type | V_{RMS} | V_{DC} | $I_{max}^{(1)}$ (8/20 μ s) 1 time | $I_n^{(2)}$ (8/20 μ s) 15 times | W_{max} (2 ms) | P_{max} |
|---------------------------------|--------------|-----------|----------|---|---|---------------------|-----------|
| | SIOV- | V | V | A | A | J | W |
| Bent strap terminals | | | | | | | |
| B72241L0131K100 | LS41K130QP | 130 | 170 | 50000 | 20000 | 310 | 1.4 |
| B72241L0141K100 | LS41K140QP | 140 | 180 | 50000 | 20000 | 340 | 1.4 |
| B72241L0151K100 | LS41K150QP | 150 | 200 | 50000 | 20000 | 360 | 1.4 |
| B72241L0231K100 | LS41K230QP | 230 | 300 | 50000 | 20000 | 460 | 1.4 |
| B72241L0251K100 | LS41K250QP | 250 | 320 | 50000 | 20000 | 490 | 1.4 |
| B72241L0271K100 | LS41K275QP | 275 | 350 | 50000 | 20000 | 550 | 1.4 |
| B72241L0321K100 | LS41K320QP | 320 | 420 | 50000 | 20000 | 640 | 1.4 |
| B72241L0381K100 | LS41K385QP | 385 | 505 | 50000 | 20000 | 800 | 1.4 |
| B72241L0421K100 | LS41K420QP | 420 | 560 | 50000 | 20000 | 910 | 1.4 |
| B72241L0441K100 | LS41K440QP | 440 | 585 | 50000 | 20000 | 950 | 1.4 |
| B72241L0461K100 | LS41K460QP | 460 | 615 | 50000 | 20000 | 960 | 1.4 |
| Straight strap terminals | | | | | | | |
| B72241L0131K102 | LS41K130QPK2 | 130 | 170 | 50000 | 20000 | 310 | 1.4 |
| B72241L0141K102 | LS41K140QPK2 | 140 | 180 | 50000 | 20000 | 340 | 1.4 |
| B72241L0151K102 | LS41K150QPK2 | 150 | 200 | 50000 | 20000 | 360 | 1.4 |
| B72241L0231K102 | LS41K230QPK2 | 230 | 300 | 50000 | 20000 | 460 | 1.4 |
| B72241L0251K102 | LS41K250QPK2 | 250 | 320 | 50000 | 20000 | 490 | 1.4 |
| B72241L0271K102 | LS41K275QPK2 | 275 | 350 | 50000 | 20000 | 550 | 1.4 |
| B72241L0321K102 | LS41K320QPK2 | 320 | 420 | 50000 | 20000 | 640 | 1.4 |
| B72241L0381K102 | LS41K385QPK2 | 385 | 505 | 50000 | 20000 | 800 | 1.4 |
| B72241L0421K102 | LS41K420QPK2 | 420 | 560 | 50000 | 20000 | 910 | 1.4 |
| B72241L0441K102 | LS41K440QPK2 | 440 | 585 | 50000 | 20000 | 950 | 1.4 |
| B72241L0461K102 | LS41K460QPK2 | 460 | 615 | 50000 | 20000 | 960 | 1.4 |

 1) I_{max} = Maximum discharge current to IEC 61643-11, class II

 2) I_n = Nominal discharge current to IEC 61643-11, class II

Strap varistors
B722*
HighE, AdvanceD, LS41 series
Characteristics (T_A = 25 °C)

| Ordering code | Type | V _v (1 mA) | ΔV _v (1 mA) | V _{c,max} (I _c) | i _c | C _{typ} (1 kHz) |
|---------------------------------|--------------|--------------------------|---------------------------|---|----------------|-----------------------------|
| | SIOV- | V | % | V | A | pF |
| Bent strap terminals | | | | | | |
| B72241L0131K100 | LS41K130QP | 205 | ±10 | 340 | 300 | 5600 |
| B72241L0141K100 | LS41K140QP | 220 | ±10 | 365 | 300 | 5200 |
| B72241L0151K100 | LS41K150QP | 240 | ±10 | 395 | 300 | 4800 |
| B72241L0231K100 | LS41K230QP | 360 | ±10 | 595 | 300 | 3200 |
| B72241L0251K100 | LS41K250QP | 390 | ±10 | 650 | 300 | 2900 |
| B72241L0271K100 | LS41K275QP | 430 | ±10 | 710 | 300 | 2700 |
| B72241L0321K100 | LS41K320QP | 510 | ±10 | 840 | 300 | 2300 |
| B72241L0381K100 | LS41K385QP | 620 | ±10 | 1025 | 300 | 1900 |
| B72241L0421K100 | LS41K420QP | 680 | ±10 | 1120 | 300 | 1800 |
| B72241L0441K100 | LS41K440QP | 715 | ±10 | 1180 | 300 | 1700 |
| B72241L0461K100 | LS41K460QP | 750 | ±10 | 1240 | 300 | 1600 |
| Straight strap terminals | | | | | | |
| B72241L0131K102 | LS41K130QPK2 | 205 | ±10 | 340 | 300 | 5600 |
| B72241L0141K102 | LS41K140QPK2 | 220 | ±10 | 365 | 300 | 5200 |
| B72241L0151K102 | LS41K150QPK2 | 240 | ±10 | 395 | 300 | 4800 |
| B72241L0231K102 | LS41K230QPK2 | 360 | ±10 | 595 | 300 | 3200 |
| B72241L0251K102 | LS41K250QPK2 | 390 | ±10 | 650 | 300 | 2900 |
| B72241L0271K102 | LS41K275QPK2 | 430 | ±10 | 710 | 300 | 2700 |
| B72241L0321K102 | LS41K320QPK2 | 510 | ±10 | 840 | 300 | 2300 |
| B72241L0381K102 | LS41K385QPK2 | 620 | ±10 | 1025 | 300 | 1900 |
| B72241L0421K102 | LS41K420QPK2 | 680 | ±10 | 1120 | 300 | 1800 |
| B72241L0441K102 | LS41K440QPK2 | 715 | ±10 | 1180 | 300 | 1700 |
| B72241L0461K102 | LS41K460QPK2 | 750 | ±10 | 1240 | 300 | 1600 |

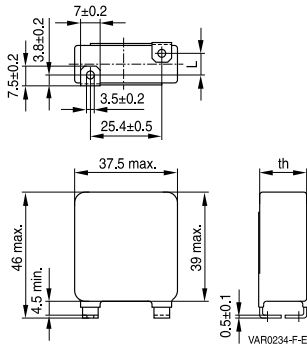
Dimensional drawings
Bent strap terminals

SIOV-LS41K ... QP

Weight: 20 ... 40 g

Straight strap terminals

SIOV-LS41K ... QPK2

Weight: 20 ... 40 g

| Ordering code | th _{max} mm | L ±1.0 mm |
|---------------------------------|-------------------------|--------------|
| Bent strap terminals | | |
| B72241L0131K100 | 8.1 | -3.5 |
| B72241L0141K100 | 8.2 | -3.3 |
| B72241L0151K100 | 8.3 | -3.2 |
| B72241L0231K100 | 9.0 | -2.0 |
| B72241L0251K100 | 9.2 | -1.8 |
| B72241L0271K100 | 9.4 | -1.6 |
| B72241L0321K100 | 9.9 | -1.1 |
| B72241L0381K100 | 10.6 | -0.4 |
| B72241L0421K100 | 10.9 | 0.0 |
| B72241L0441K100 | 11.1 | 0.2 |
| B72241L0461K100 | 11.4 | 0.4 |
| Straight strap terminals | | |
| B72241L0131K102 | 8.1 | 4.4 |
| B72241L0141K102 | 8.2 | 4.5 |
| B72241L0151K102 | 8.3 | 4.6 |
| B72241L0231K102 | 9.0 | 5.4 |
| B72241L0251K102 | 9.2 | 5.6 |
| B72241L0271K102 | 9.4 | 5.8 |
| B72241L0321K102 | 9.9 | 6.3 |
| B72241L0381K102 | 10.6 | 6.9 |
| B72241L0421K102 | 10.9 | 7.3 |
| B72241L0441K102 | 11.1 | 7.6 |
| B72241L0461K102 | 11.4 | 7.8 |

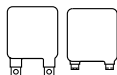

Strap varistors
B722*
HighE, AdvanceD, LS41 series
Reliability data

| Test | Test methods/conditions | Requirement |
|--------------------------------------|--|--|
| Varistor voltage | The voltage between two terminals with the specified measuring current applied is called V_V (1 mA _{DC} @ 0.2 ... 2 s). | To meet the specified value |
| Clamping voltage | The maximum voltage between two terminals with the specified standard impulse current (8/20 μ s) applied. | To meet the specified value |
| Max. DC operating voltage | The maximum allowable DC operating voltage V_{DC} at UCT +5/-0 °C is applied for 1000 \pm 48 h. The leakage current $I_{leak}(t)$ during test is recorded. Then the specimen shall be stored at room temperature and normal humidity for 1 to 2 h. Thereafter, the change of V_V shall be measured. | $I_{leak}(t = 1000 \text{ h}) \leq I_{leak}(t = 0 \text{ h})$ $ \Delta V/V (1 \text{ mA}) \leq 10\%$ |
| Surge current derating, 8/20 μ s | 10 surge currents (8/20 μ s), unipolar, interval \geq 60 s, amplitude corresponding to derating curve for 10 impulses at 20 μ s | $ \Delta V/V (1 \text{ mA}) \leq 10\%$ (measured in direction of surge current) No visible damage |
| Fast temperature cycling | IEC 60068-2-14, test Na, LCT/UCT, dwell time 30 min, 5 cycles | $ \Delta V/V (1 \text{ mA}) \leq 10\%$ No visible damage |
| Damp heat, steady state | IEC 60068-2-78 The specimen shall be subjected to 40 \pm 2 °C, 90 to 95% r. H. for 56 \pm 2 days with 10% of the maximum continuous DC operating voltage V_{DC} . Then stored at room temperature and normal humidity for 1 to 2 h. Thereafter, the change of V_V shall be measured. | $ \Delta V/V (1 \text{ mA}) \leq 10\%$ |

Note:

UCT = Upper category temperature

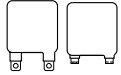
LCT = Lower category temperature



v/i characteristics

$v = f(i)$ for explanation of the characteristics refer to "General technical information", chapter 1.6.3
 A = Leakage current, B = Protection level } for worst-case varistor tolerances

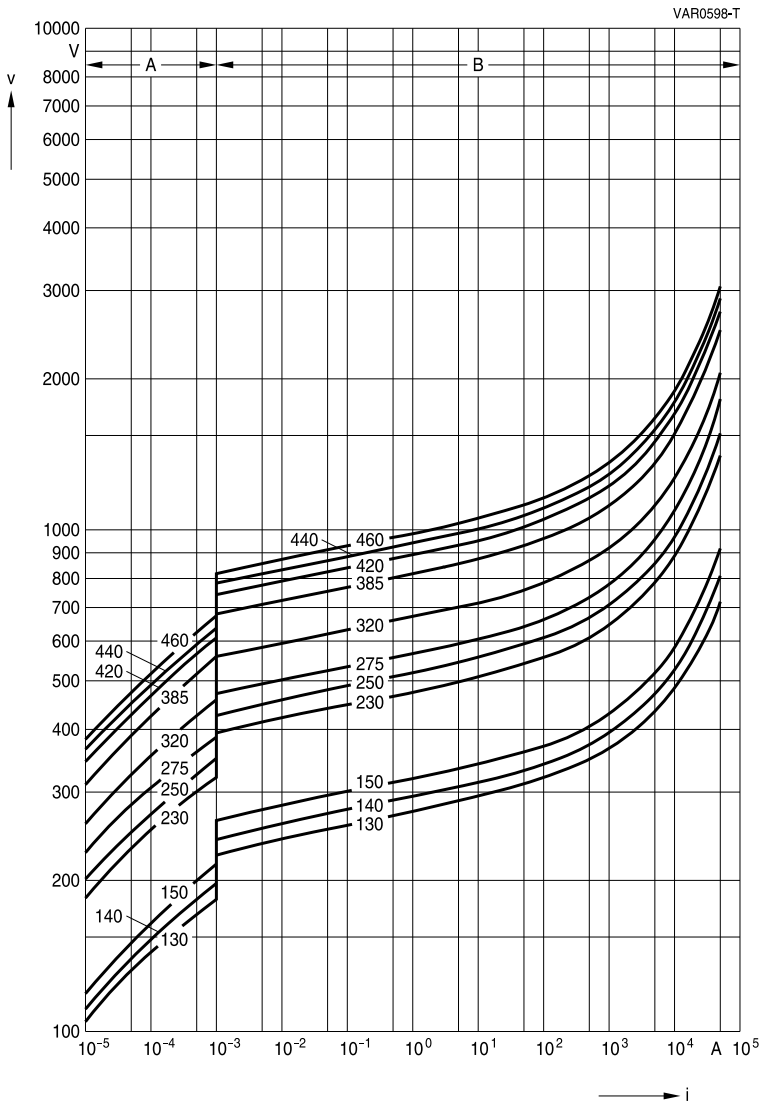

SIOV-LS41K130QP(K2) ... K460QP(K2)



Derating curves

Maximum surge current $i_{max} = f(t_r, \text{pulse train})$

For explanation of the derating curves refer to "General technical information", section 1.8.1

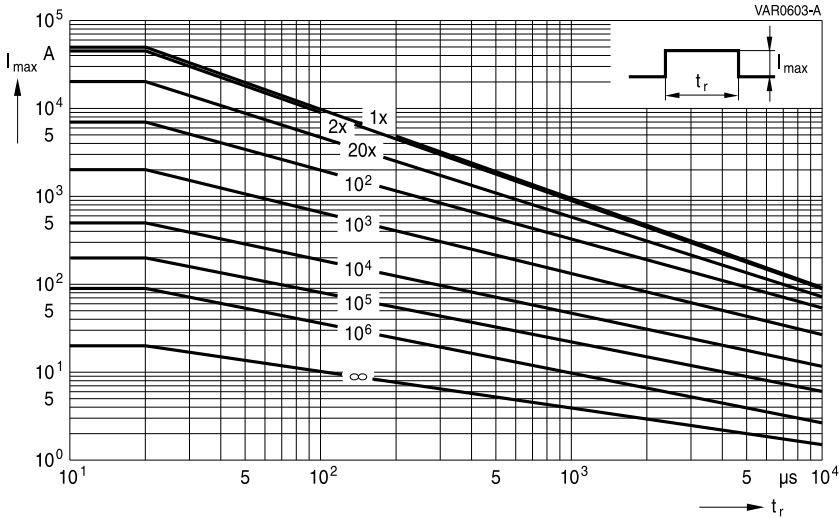

SIOV-LS41K130QP(K2) ... K150QP(K2)

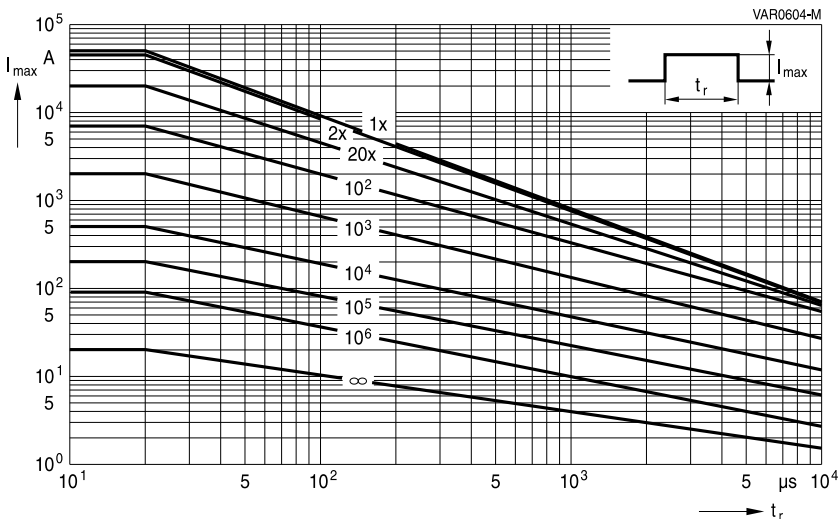

SIOV-LS41K230QP(K2) ... K460QP(K2)



Cautions and warnings

General

1. EPCOS metal oxide varistors are designed for specific applications and should not be used for purposes not identified in our specifications, application notes and data books unless otherwise agreed with EPCOS during the design-in-phase.
2. Ensure suitability of SIOVs through reliability testing during the design-in phase. SIOVs should be evaluated taking into consideration worst-case conditions.
3. For applications of SIOVs in line-to-ground circuits based on various international and local standards there are restrictions existing or additional safety measures required.

Storage

1. Store SIOVs only in original packaging. Do not open the package prior to processing.
2. Recommended storage conditions in original packaging:
 Storage temperature: $-25\text{ }^{\circ}\text{C} \dots +45\text{ }^{\circ}\text{C}$,
 Relative humidity: $<75\%$ annual average,
 $<95\%$ on maximum 30 days a year.
 Dew precipitation: is to be avoided.
3. Avoid contamination of an SIOV's during storage, handling and processing.
4. Avoid storage of SIOVs in harmful environments that can affect the function during long-term operation (examples given under operation precautions).
5. The SIOV type series should be soldered after shipment from EPCOS within the time specified:

| | |
|---------------------------|------------|
| SIOV-S, -Q, -LS, -B, -SNF | 24 months |
| ETFV/ T series, -CU | 12 months. |

Handling

1. SIOVs must not be dropped.
2. Components must not be touched with bare hands. Gloves are recommended.
3. Avoid contamination of the surface of SIOV electrodes during handling, be careful of the sharp edge of SIOV electrodes.

Soldering (where applicable)

1. Use rosin-type flux or non-activated flux.
2. Insufficient preheating may cause ceramic cracks.
3. Rapid cooling by dipping in solvent is not recommended.
4. Complete removal of flux is recommended.
5. Temperatures of all preheat stages and the solder bath must be strictly controlled especially for T series (T14 and T20).

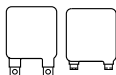

Mounting

1. Potting, sealing or adhesive compounds can produce chemical reactions in the SIOV ceramic that will degrade the component's electrical characteristics.
2. Overloading SIOVs may result in ruptured packages and expulsion of hot materials. For this reason SIOVs should be physically shielded from adjacent components.

Operation

1. Use SIOVs only within the specified temperature operating range.
2. Use SIOVs only within the specified voltage and current ranges.
3. Environmental conditions must not harm SIOVs. Use SIOVs only in normal atmospheric conditions. Avoid use in deoxidizing gases (chlorine gas, hydrogen sulfide gas, ammonia gas, sulfuric acid gas etc), corrosive agents, humid or salty conditions. Contact with any liquids and solvents should be prevented.

Display of ordering codes for EPCOS products

The ordering code for one and the same EPCOS product can be represented differently in data sheets, data books, other publications, on the EPCOS website, or in order-related documents such as shipping notes, order confirmations and product labels. **The varying representations of the ordering codes are due to different processes employed and do not affect the specifications of the respective products.** Detailed information can be found on the Internet under www.epcos.com/orderingcodes

Symbols and terms

| Symbol | Term |
|--------------------|--|
| C | Capacitance |
| C_{typ} | Typical capacitance |
| i | Current |
| i_c | Current at which $V_{c, max}$ is measured |
| I_{leak} | Leakage current |
| i_{max} | Maximum surge current (also termed peak current) |
| I_{max} | Maximum discharge current |
| I_n | Nominal discharge current to UL 1449 |
| LCT | Lower category temperature |
| L_{typ} | Typical inductance |
| P_{max} | Maximum average power dissipation |
| R_{ins} | Insulation resistance |
| R_{min} | Minimum resistance |
| T_A | Ambient temperature |
| t_r | Duration of equivalent rectangular wave |
| UCT | Upper category temperature |
| v | Voltage |
| V_{clamp} | Clamping voltage |
| $V_{c, max}$ | Maximum clamping voltage at specified current i_c |
| V_{DC} | DC operating voltage |
| V_{jump} | Maximum jump start voltage |
| V_{max} | Maximum voltage |
| V_{op} | Operating voltage |
| V_{RMS} | AC operating voltage, root-mean-square value |
| $V_{RMS, op, max}$ | Root-mean-square value of max. DC operating voltage incl. ripple current |
| V_{surge} | Super imposed surge voltage |
| V_V | Varistor voltage |
| ΔV_V | Tolerance of varistor voltage |
| W_{LD} | Maximum load dump |
| W_{max} | Maximum energy absorption |
| e | Lead spacing |

All dimensions are given in mm.

The commas used in numerical values denote decimal points.

Important notes

The following applies to all products named in this publication:

1. Some parts of this publication contain **statements about the suitability of our products for certain areas of application**. These statements are based on our knowledge of typical requirements that are often placed on our products in the areas of application concerned. We nevertheless expressly point out **that such statements cannot be regarded as binding statements about the suitability of our products for a particular customer application**. As a rule we are either unfamiliar with individual customer applications or less familiar with them than the customers themselves. For these reasons, it is always ultimately incumbent on the customer to check and decide whether a product with the properties described in the product specification is suitable for use in a particular customer application.
2. We also point out that **in individual cases, a malfunction of electronic components or failure before the end of their usual service life cannot be completely ruled out in the current state of the art, even if they are operated as specified**. In customer applications requiring a very high level of operational safety and especially in customer applications in which the malfunction or failure of an electronic component could endanger human life or health (e.g. in accident prevention or life-saving systems), it must therefore be ensured by means of suitable design of the customer application or other action taken by the customer (e.g. installation of protective circuitry or redundancy) that no injury or damage is sustained by third parties in the event of malfunction or failure of an electronic component.
3. **The warnings, cautions and product-specific notes must be observed.**
4. In order to satisfy certain technical requirements, **some of the products described in this publication may contain substances subject to restrictions in certain jurisdictions (e.g. because they are classified as hazardous)**. Useful information on this will be found in our Material Data Sheets on the Internet (www.tdk-electronics.tdk.com/material). Should you have any more detailed questions, please contact our sales offices.
5. We constantly strive to improve our products. Consequently, **the products described in this publication may change from time to time**. The same is true of the corresponding product specifications. Please check therefore to what extent product descriptions and specifications contained in this publication are still applicable before or when you place an order.

We also **reserve the right to discontinue production and delivery of products**. Consequently, we cannot guarantee that all products named in this publication will always be available. The aforementioned does not apply in the case of individual agreements deviating from the foregoing for customer-specific products.
6. Unless otherwise agreed in individual contracts, **all orders are subject to our General Terms and Conditions of Supply**.
7. **Our manufacturing sites serving the automotive business apply the IATF 16949 standard**. The IATF certifications confirm our compliance with requirements regarding the quality management system in the automotive industry. Referring to customer requirements and customer specific requirements ("CSR") TDK always has and will continue to have the policy of respecting individual agreements. Even if IATF 16949 may appear to support the acceptance of unilateral requirements, we hereby like to emphasize that **only requirements mutually agreed upon can and will be implemented in our Quality Management System**. For clarification purposes we like to point out that obligations from IATF 16949 shall only become legally binding if individually agreed upon.

Important notes

8. The trade names EPCOS, CeraCharge, CeraDiode, CeraLink, CeraPad, CeraPlas, CSMP, CTVS, DeltaCap, DigiSiMic, ExoCore, FilterCap, FormFit, LeaXield, MiniBlue, MiniCell, MKD, MKK, MotorCap, PCC, PhaseCap, PhaseCube, PhaseMod, PhiCap, PowerHap, PQSine, PQvar, SIFERRIT, SIFI, SIKOREL, SilverCap, SIMDAD, SiMic, SIMID, SineFormer, SIOV, ThermoFuse, WindCap are **trademarks registered or pending** in Europe and in other countries. Further information will be found on the Internet at www.tdk-electronics.tdk.com/trademarks.

Release 2018-10

Mouser Electronics

Authorized Distributor

Click to View Pricing, Inventory, Delivery & Lifecycle Information:

EPCOS / TDK:

[B72241L0131K100](#) [B72241L0151K100](#) [B72241L0231K100](#) [B72241L0251K100](#) [B72241L0271K100](#)
[B72241L0321K100](#) [B72241L0381K100](#) [B72241L0421K100](#) [B72241L0441K100](#) [B72241L0461K100](#)

Данный компонент на территории Российской Федерации

Вы можете приобрести в компании MosChip.

Для оперативного оформления запроса Вам необходимо перейти по данной ссылке:

<http://moschip.ru/get-element>

Вы можете разместить у нас заказ для любого Вашего проекта, будь то серийное производство или разработка единичного прибора.

В нашем ассортименте представлены ведущие мировые производители активных и пассивных электронных компонентов.

Нашей специализацией является поставка электронной компонентной базы двойного назначения, продукции таких производителей как XILINX, Intel (ex.ALTERA), Vicor, Microchip, Texas Instruments, Analog Devices, Mini-Circuits, Amphenol, Glenair.

Сотрудничество с глобальными дистрибьюторами электронных компонентов, предоставляет возможность заказывать и получать с международных складов практически любой перечень компонентов в оптимальные для Вас сроки.

На всех этапах разработки и производства наши партнеры могут получить квалифицированную поддержку опытных инженеров.

Система менеджмента качества компании отвечает требованиям в соответствии с ГОСТ Р ИСО 9001, ГОСТ РВ 0015-002 и ЭС РД 009

Офис по работе с юридическими лицами:

105318, г.Москва, ул.Щербаковская д.3, офис 1107, 1118, ДЦ «Щербаковский»

Телефон: +7 495 668-12-70 (многоканальный)

Факс: +7 495 668-12-70 (доб.304)

E-mail: info@moschip.ru

Skype отдела продаж:

moschip.ru

moschip.ru_4

moschip.ru_6

moschip.ru_9