

**FEATURES**

- Conversion gain: 10 dB typical**
- Image rejection: 30 dBc typical**
- Noise figure: 6 dB typical**
- Input power for 1 dB compression (P1dB): -10 dBm typical**
- Input third-order intercept (IP3): -2 dBm typical**
- Input second-order intercept (IP2): 25 dBm typical**
- 6× LO leakage at RFIN: -40 dBm typical**
- Radio frequency (RF) return loss: 10 dB typical**
- Local oscillator (LO) return loss: 20 dB typical**
- Die size: 3.599 mm × 2.199 mm × 0.05 mm**

**APPLICATIONS**

- E-band communication systems**
- High capacity wireless backhauls**
- Test and measurement**

**GENERAL DESCRIPTION**

The **HMC7587** is an integrated, E-band gallium arsenide (GaAs), monolithic microwave integrated circuit (MMIC), in-phase/quadrature (I/Q) downconverter chip that operates from 81 GHz to 86 GHz. The **HMC7587** provides a small signal conversion gain of 10 dB with 30 dBc of image rejection across the frequency band. The device uses a low noise amplifier followed by an image rejection mixer that is driven by a 6× multiplier.

The image rejection mixer eliminates the need for a filter following the low noise amplifier. Differential I and Q mixer outputs are provided for direct conversion applications. Alternatively, the outputs can be combined using an external 90° hybrid and two external 180° hybrids to allow for single-sideband applications. All data includes the effect of a 3 mil wide ribbon wedge bond on the RF port, and a 1 mil gold wire wedge bond on the intermediate frequency (IF) ports.

**FUNCTIONAL BLOCK DIAGRAM**

Figure 1.

## TABLE OF CONTENTS

Features .....	1	Spurious Performance with Upper Sideband Selected, IF = 500 MHz .....	44
Applications .....	1	Spurious Performance with Upper Sideband Selected, IF = 1000 MHz .....	45
General Description .....	1	Spurious Performance with Upper Sideband Selected, IF = 2000 MHz .....	46
Functional Block Diagram .....	1	Spurious Performance with Lower Sideband Selected, IF = 500 MHz .....	47
Revision History .....	2	Spurious Performance with Lower Sideband Selected, IF = 1000 MHz .....	48
Specifications .....	3	Spurious Performance with Lower Sideband Selected, IF = 2000 MHz .....	49
Absolute Maximum Ratings .....	4	Theory of Operation .....	50
Thermal Resistance .....	4	Applications Information .....	51
ESD Caution .....	4	Biasing Sequence .....	51
Pin Configuration and Function Descriptions .....	5	Image Rejection Downconversion .....	51
Interface Schematics .....	6	Zero IF Direct Conversion .....	52
Typical Performance Characteristics .....	7	Assembly Diagram .....	53
Upper Sideband Selected, IF = 500 MHz .....	7	Mounting and Bonding Techniques for Millimeterwave GaAs MMICs .....	54
Upper Sideband Selected, IF = 1000 MHz .....	13	Handling Precautions .....	54
Upper Sideband Selected, IF = 2000 MHz .....	18	Mounting .....	54
Noise Figure Performance with Upper Sideband Selected ...	23	Wire Bonding .....	54
Amplitude Balance Performance with Upper Sideband Selected .....	24	Outline Dimensions .....	55
Phase Balance Performance with Upper Sideband Selected	25	Ordering Guide .....	55
Lower Sideband Selected, IF = 500 MHz .....	26		
Lower Sideband Selected, IF = 1000 MHz .....	31		
Lower Sideband Selected, IF = 2000 MHz .....	36		
Noise Figure Performance with Lower Sideband Selected ...	41		
Amplitude Balance Performance with Lower Sideband Selected .....	42		
Phase Balance Performance with Lower Sideband Selected.	43		

## REVISION HISTORY

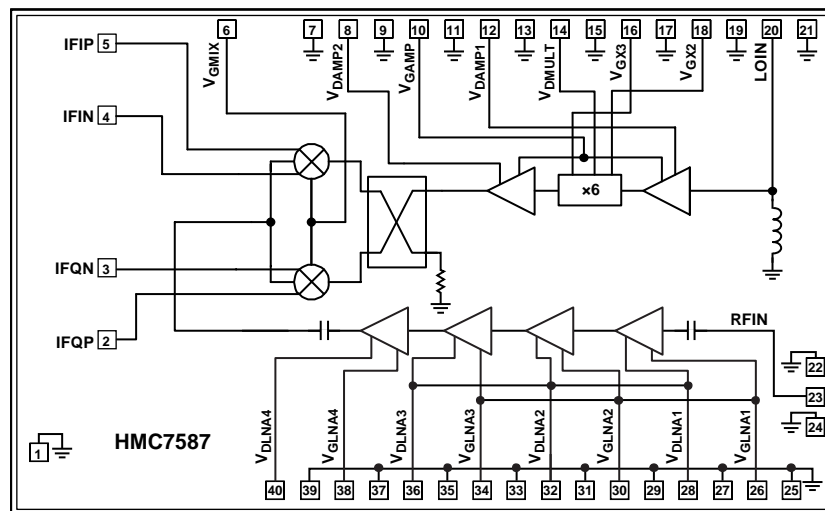
3/16—Revision A: Initial Version

## SPECIFICATIONS

$T_A = 25^\circ\text{C}$ ,  $IF = 500\text{ MHz}$ ,  $V_{GMIX} = -1\text{ V}$ ,  $V_{DAMPx} = 4\text{ V}$ ,  $V_{DMULT} = 1.5\text{ V}$ , voltage on the  $V_{DLNAX}$  pins ( $V_{DLNA}$ ) =  $3\text{ V}$ ,  $LO = 2\text{ dBm}$ , upper sideband selected. Measurements performed as a downconverter with external  $90^\circ$  and  $180^\circ$  hybrids at the IF ports, unless otherwise noted.

Table 1.

Parameter	Test Conditions/Comments	Min	Typ	Max	Unit
<b>OPERATING CONDITIONS</b>					
RF Frequency Range		81		86	GHz
LO Frequency Range		11.83		14.33	GHz
IF Frequency Range		0		10	GHz
LO Drive Range		2		8	dBm
<b>PERFORMANCE</b>					
Conversion Gain		8	10		dB
Image Rejection		20	30		dBc
Input Third-Order Intercept (IP3)			-2		dBm
Input Second-Order Intercept (IP2)			25		dBm
Input Power for 1 dB Compression (P1dB)			-10		dBm
6× LO Leakage at RF Input (RFIN)			-40		dBm
1× LO Leakage at IF Output (IFOUT)			-50		dBm
Amplitude Balance <sup>1</sup>			-0.5		dB
Phase Balance <sup>1</sup>			±4		Degrees
Noise Figure			6		dB
RF Return Loss	LO = 2 dBm at 12 GHz		10		dB
LO Return Loss			20		dB
IF Return Loss <sup>1</sup>			25		dB
<b>POWER SUPPLY</b>					
Supply Current					
$I_{DAMP}^2$	Under LO drive		175		mA
$I_{DMULT}^3$			80		mA
$I_{DLNA}^4$			50		mA

<sup>1</sup> These measurements were performed without external hybrids at the IF ports.

<sup>2</sup> Adjust  $V_{GAMP}$  between  $-2\text{ V}$  and  $0\text{ V}$  to achieve the total quiescent current,  $I_{DAMP} = I_{DAMP1} + I_{DAMP2} = 175\text{ mA}$ .

<sup>3</sup> Adjust  $V_{GX2}$  and  $V_{GX3}$  between  $-2\text{ V}$  and  $0\text{ V}$  to achieve the quiescent current,  $I_{DMULT} = 1\text{ mA}$  to  $2\text{ mA}$ . See the Applications Information section for more information.

<sup>4</sup> Adjust  $V_{GLNAX}$  between  $-2\text{ V}$  and  $0\text{ V}$  to achieve the quiescent current,  $I_{DLNA1} + I_{DLNA2} + I_{DLNA3} + I_{DLNA4} = 50\text{ mA}$ .

## ABSOLUTE MAXIMUM RATINGS

Table 2.

Parameter	Rating
Drain Bias Voltage	
$V_{DAMP1}, V_{DAMP2}$	4.5 V
$V_{DMULT}$	3 V
$V_{DLNA1}, V_{DLNA2}, V_{DLNA3}, V_{DLNA4}$	4.5 V
Gate Bias Voltage	
$V_{GAMP}$	-3 V to 0 V
$V_{GX2}, V_{GX3}$	-3 V to 0 V
$V_{GLNA1}, V_{GLNA2}, V_{GLNA3}, V_{GLNA4}$	-3 V to 0 V
$V_{GMIX}$	-3 V to 0 V
LO Input Power	10 dBm
Maximum Junction Temperature (to Maintain 1 Million Hours Mean Time to Failure (MTTF))	175°C
Storage Temperature Range	-65°C to +150°C
Operating Temperature Range	-55°C to +85°C

Stresses at or above those listed under Absolute Maximum Ratings may cause permanent damage to the product. This is a stress rating only; functional operation of the product at these or any other conditions above those indicated in the operational section of this specification is not implied. Operation beyond the maximum operating conditions for extended periods may affect product reliability.

## THERMAL RESISTANCE

Table 3. Thermal Resistance

Package Type	$\theta_{JC}^1$	Unit
40-Pad Bare Die [CHIP]	61.7	°C/W

<sup>1</sup> Based on ABLEBOND® 84-1LMIT as die attach epoxy with thermal conductivity of 3.6 W/mK.

## ESD CAUTION



**ESD (electrostatic discharge) sensitive device.** Charged devices and circuit boards can discharge without detection. Although this product features patented or proprietary protection circuitry, damage may occur on devices subjected to high energy ESD. Therefore, proper ESD precautions should be taken to avoid performance degradation or loss of functionality.

### PIN CONFIGURATION AND FUNCTION DESCRIPTIONS

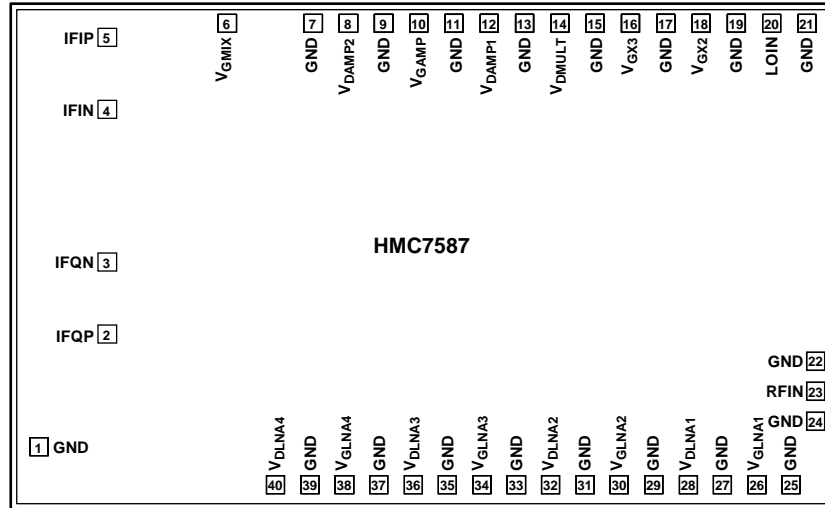

Figure 2. Pad Configuration

Table 4. Pad Function Descriptions

Pad No.	Mnemonic	Description
1, 7, 9, 11, 13, 15, 17, 19, 21, 22, 24, 25, 27, 29, 31, 33, 35, 37, 39	GND	Ground Connect (See Figure 3).
2, 3	IFQP, IFQN	Positive and Negative IF Q Inputs. These pads are dc-coupled. When operation to dc is not required, block these pads externally using a series capacitor with a value chosen to pass the necessary frequency range. For operation to dc, these pads must not source or sink more than 3 mA of current or die malfunction and possible die failure may result (see Figure 4).
4, 5	IFIN, IFIP	Negative and Positive IF I Inputs. These pads are dc-coupled. When operation to dc is not required, block these pads externally using a series capacitor with a value chosen to pass the necessary frequency range. For operation to dc, these pads must not source or sink more than 3 mA of current or die malfunction and possible die failure may result (see Figure 4).
6	VG MIX	Gate Voltage for the FET Mixer (See Figure 5). External bypass capacitors of 120 pF, 0.01 μF, and 4.7 μF are recommended (see Figure 211).
8, 12	VDAMP2, VDAMP1	Power Supply Voltage for the First and the Second Stage LO Amplifier (See Figure 5). External bypass capacitors of 120 pF, 0.01 μF, and 4.7 μF are recommended (see Figure 211).
10	VGAMP	Gate Voltage for the First and the Second Stage LO Amplifier (See Figure 5). External bypass capacitors of 120 pF, 0.01 μF, and 4.7 μF are recommended (see Figure 211).
14	VDMULT	Power Supply Voltage for the LO Multiplier (See Figure 5). External bypass capacitors of 120 pF, 0.01 μF, and 4.7 μF are recommended (see Figure 211).
16, 18	VGX3, VGX2	Gate Voltage for the LO Multiplier (See Figure 5). External bypass capacitors of 120 pF, 0.01 μF, and 4.7 μF are recommended (see Figure 211).
20	LOIN	Local Oscillator Input. This pad is dc-coupled and matched to 50 Ω (see Figure 6).
23	RFIN	RF Input. This pad is ac-coupled and matched to 50 Ω (see Figure 7).
26, 30, 34, 38	VGLNA1, VGLNA2, VGLNA3, VGLNA4	Gate Voltage for the Low Noise Amplifier (See Figure 8). External bypass capacitors of 120 pF, 0.01 μF, and 4.7 μF are recommended (see Figure 211).
28, 32, 36, 40	VDLNA1, VDLNA2, VDLNA3, VDLNA4	Power Supply Voltage for the Low Noise Amplifier (See Figure 8). External bypass capacitors of 120 pF, 0.01 μF, and 4.7 μF are recommended (see Figure 211).
Die Bottom	GND	Ground. The die bottom must be connected to RF/dc ground (see Figure 3).

INTERFACE SCHEMATICS



Figure 3. GND Interface

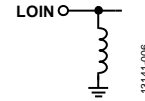

Figure 6. LOIN Interface

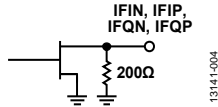

Figure 4. IFIN, IFIP, IFQN, and IFQP Interface

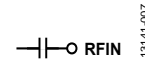

Figure 7. RFIN Interface

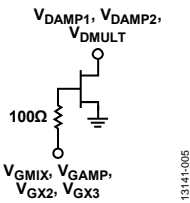

Figure 5.  $V_{GMIX}$ ,  $V_{DAMP1}$ ,  $V_{DAMP2}$ ,  $V_{DMULT}$ ,  $V_{GAMP}$ ,  $V_{GX2}$ , and  $V_{GX3}$  Interface

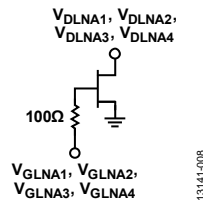

Figure 8.  $V_{DLNA1}$ ,  $V_{DLNA2}$ ,  $V_{DLNA3}$ ,  $V_{DLNA4}$ ,  $V_{GLNA1}$ ,  $V_{GLNA2}$ ,  $V_{GLNA3}$ , and  $V_{GLNA4}$  Interface

# TYPICAL PERFORMANCE CHARACTERISTICS

## UPPER SIDEBAND SELECTED, IF = 500 MHz

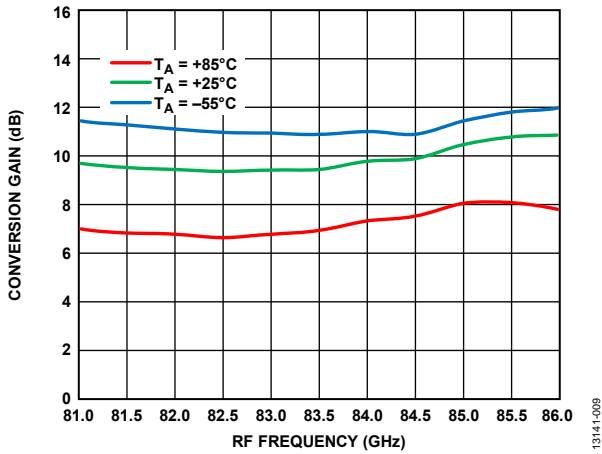

Figure 9. Conversion Gain vs. RF Frequency at Various Temperatures,  $R_{FIN} = -20$  dBm,  $LO = 2$  dBm,  $IF = 500$  MHz, Voltage on the  $V_{DLNAx}$  Pins ( $V_{DLNA} = 4$  V

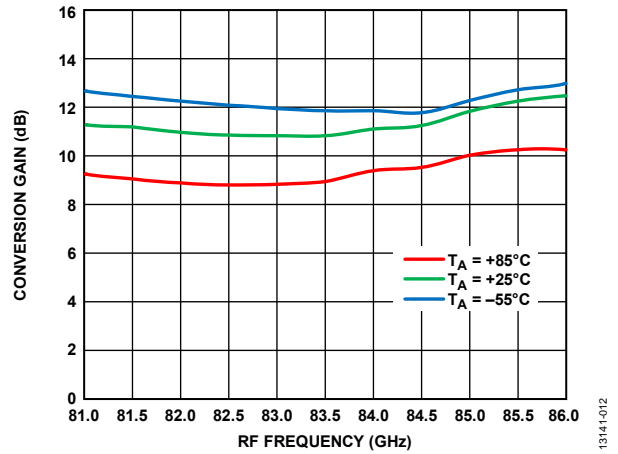

Figure 12. Conversion Gain vs. RF Frequency at Various Temperatures,  $R_{FIN} = -20$  dBm,  $LO = 2$  dBm,  $IF = 500$  MHz,  $V_{DLNA} = 3$  V

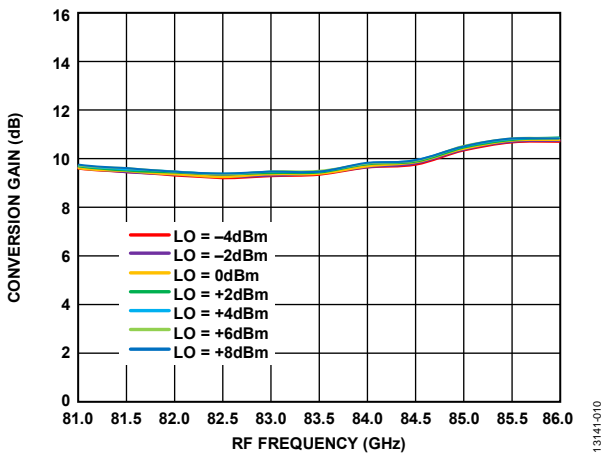

Figure 10. Conversion Gain vs. RF Frequency at Various LO Powers,  $R_{FIN} = -20$  dBm,  $IF = 500$  MHz,  $V_{DLNA} = 4$  V

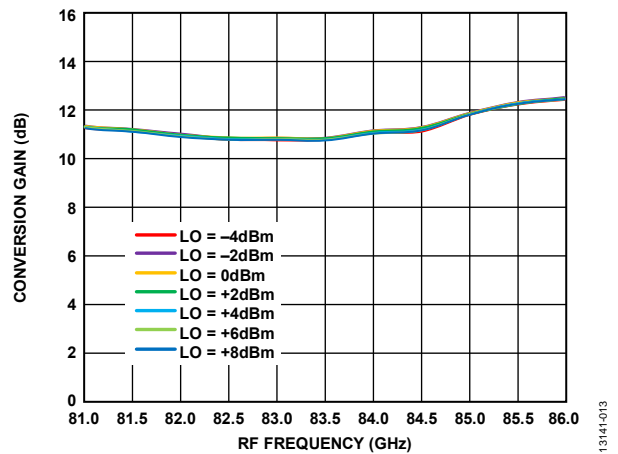

Figure 13. Conversion Gain vs. RF Frequency at Various LO Powers,  $R_{FIN} = -20$  dBm,  $IF = 500$  MHz,  $V_{DLNA} = 3$  V

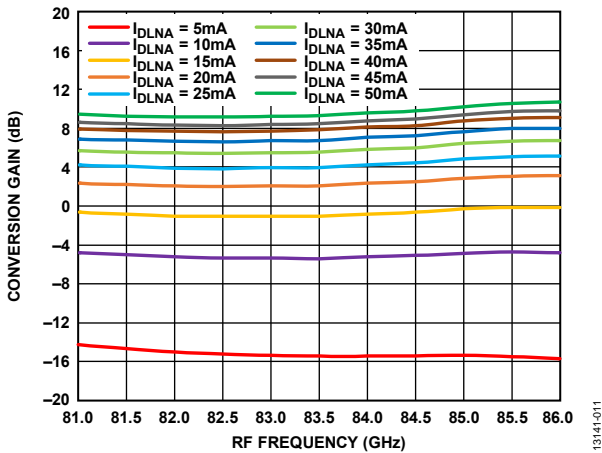

Figure 11. Conversion Gain vs. RF Frequency at Various  $I_{DLNA}$  Values,  $R_{FIN} = -20$  dBm,  $LO = 2$  dBm,  $IF = 500$  MHz,  $V_{DLNA} = 4$  V

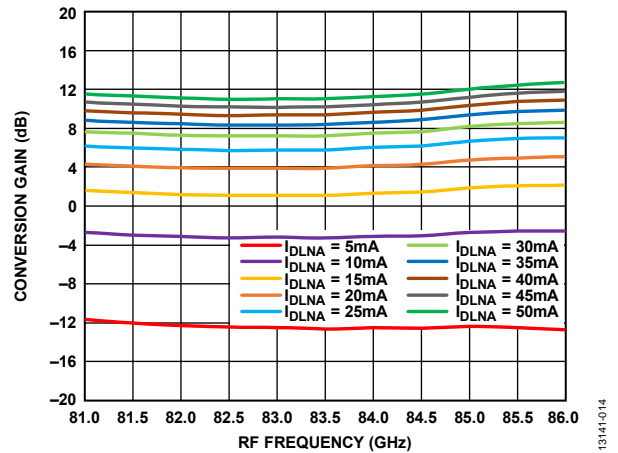

Figure 14. Conversion Gain vs. RF Frequency at Various  $I_{DLNA}$  Values,  $R_{FIN} = -20$  dBm,  $LO = 2$  dBm,  $IF = 500$  MHz,  $V_{DLNA} = 3$  V

13141-009

13141-012

13141-010

13141-013

13141-011

13141-014

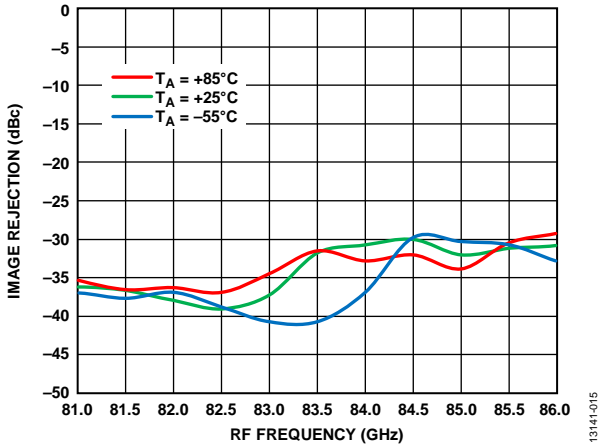

Figure 15. Image Rejection vs. RF Frequency at Various Temperatures,  $R_{FIN} = -20$  dBm,  $L_O = 2$  dBm,  $I_F = 500$  MHz,  $V_{DLNA} = 4$  V

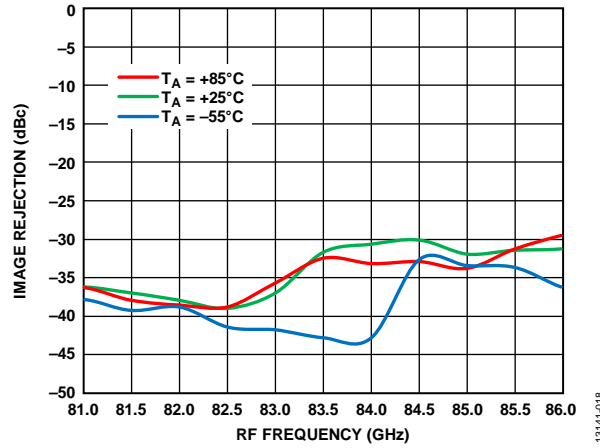

Figure 18. Image Rejection vs. RF Frequency at Various Temperatures,  $R_{FIN} = -20$  dBm,  $L_O = 2$  dBm,  $I_F = 500$  MHz,  $V_{DLNA} = 3$  V

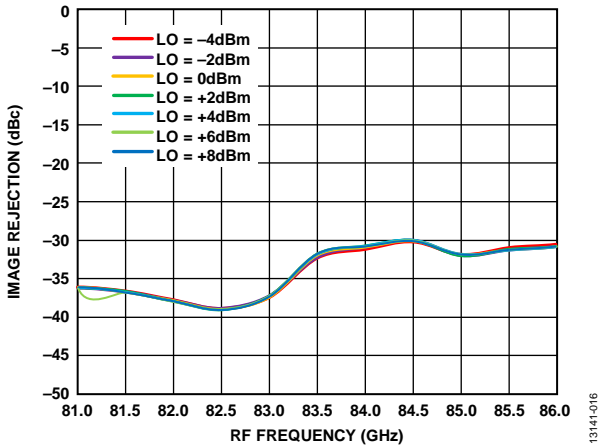

Figure 16. Image Rejection vs. RF Frequency at Various LO Powers,  $R_{FIN} = -20$  dBm,  $I_F = 500$  MHz,  $V_{DLNA} = 4$  V

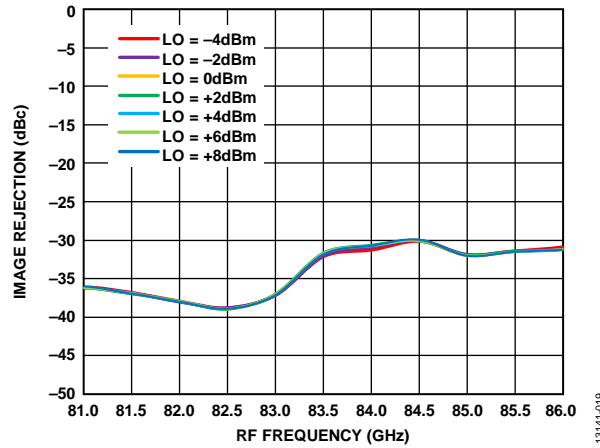

Figure 19. Image Rejection vs. RF Frequency at Various LO Powers,  $R_{FIN} = -20$  dBm,  $I_F = 500$  MHz,  $V_{DLNA} = 3$  V

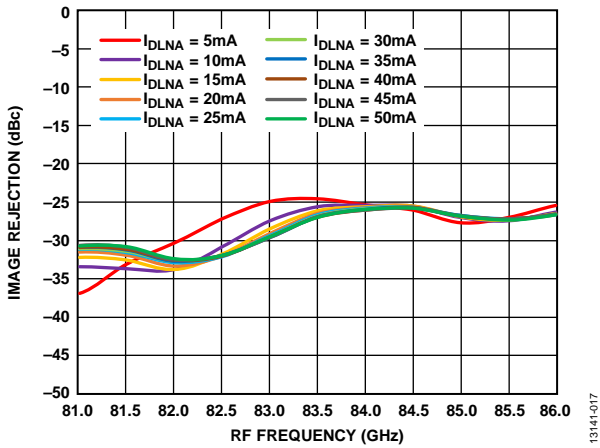

Figure 17. Image Rejection vs. RF Frequency at Various  $I_{DLNA}$  Values,  $R_{FIN} = -20$  dBm,  $L_O = 2$  dBm,  $I_F = 500$  MHz,  $V_{DLNA} = 4$  V

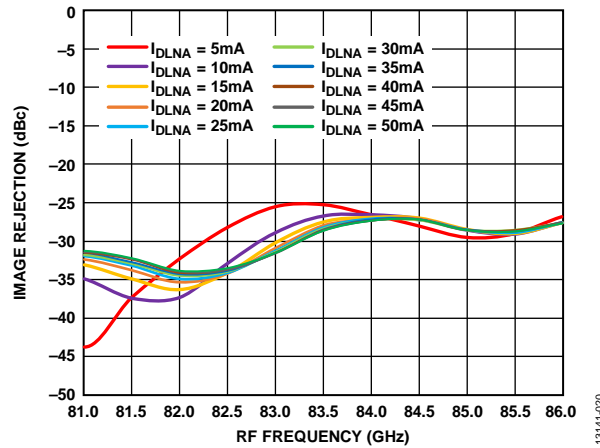

Figure 20. Image Rejection vs. RF Frequency at Various  $I_{DLNA}$  Values,  $R_{FIN} = -20$  dBm,  $L_O = 2$  dBm,  $I_F = 500$  MHz,  $V_{DLNA} = 3$  V



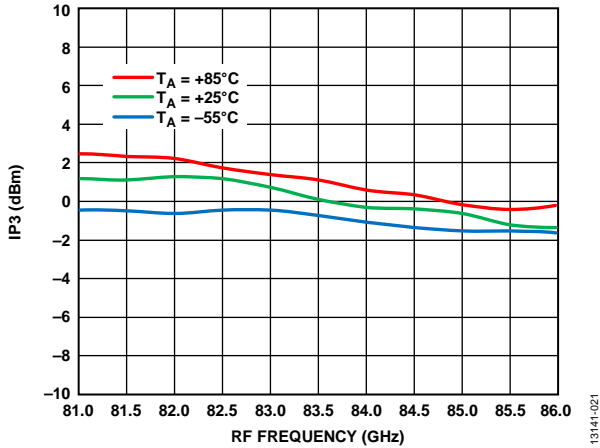

Figure 21. Input IP3 vs. RF Frequency at Various Temperatures,  $R_{FIN} = -20$  dBm, LO = 2 dBm, IF = 500 MHz,  $V_{DLNA} = 4$  V

13141-021

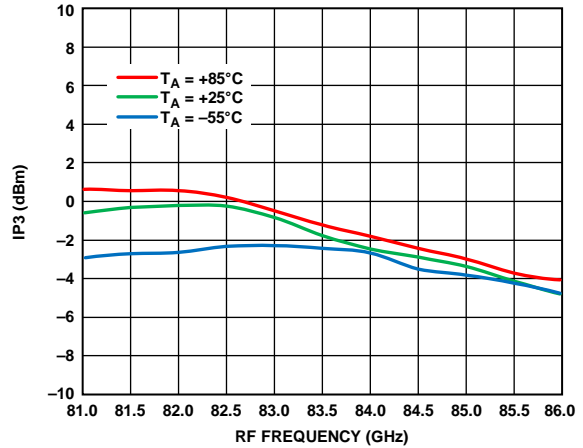

Figure 24. Input IP3 vs. RF Frequency at Various Temperatures,  $R_{FIN} = -20$  dBm, LO = 2 dBm, IF = 500 MHz,  $V_{DLNA} = 3$  V

13141-024

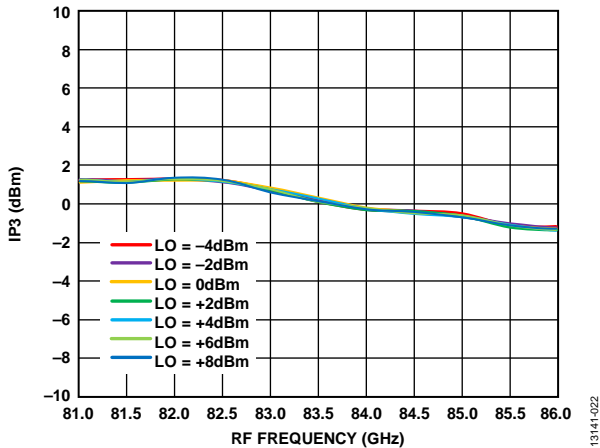

Figure 22. Input IP3 vs. RF Frequency at Various LO Powers,  $R_{FIN} = -20$  dBm, IF = 500 MHz,  $V_{DLNA} = 4$  V

13141-022

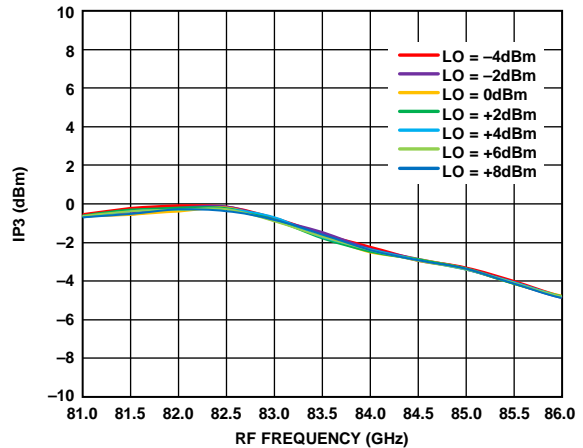

Figure 25. Input IP3 vs. RF Frequency at Various LO Powers,  $R_{FIN} = -20$  dBm, IF = 500 MHz,  $V_{DLNA} = 3$  V

13141-025

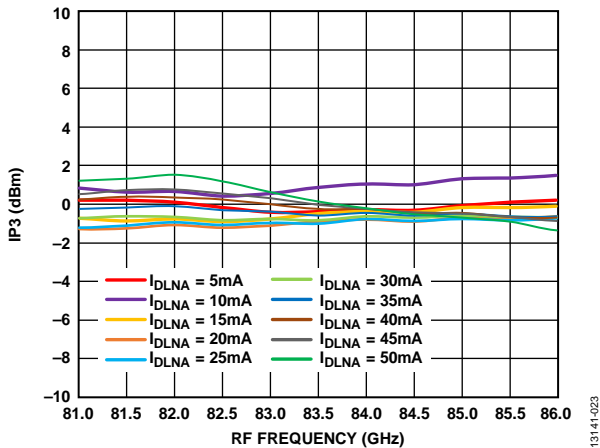

Figure 23. Input IP3 vs. RF Frequency at Various  $I_{DLNA}$  Values,  $R_{FIN} = -20$  dBm, LO = 2 dBm, IF = 500 MHz,  $V_{DLNA} = 4$  V

13141-023

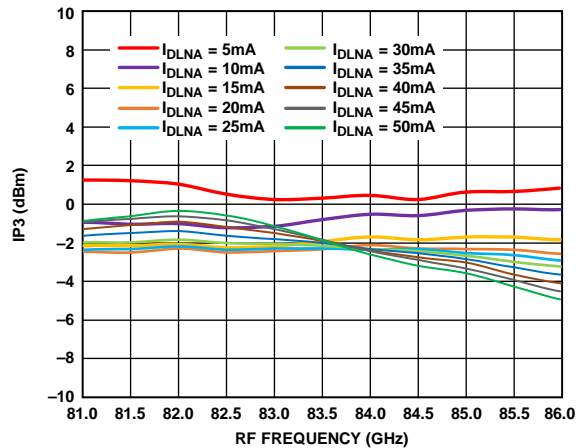
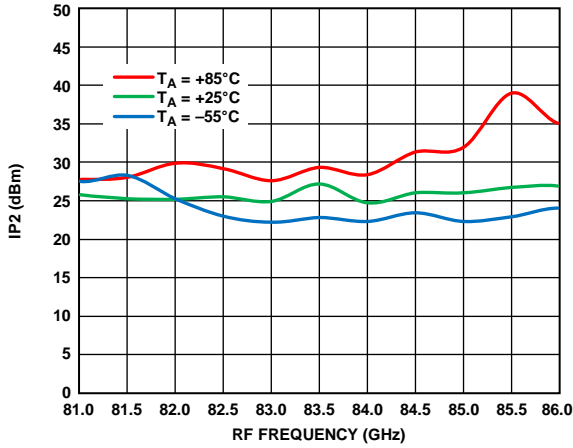

Figure 26. Input IP3 vs. RF Frequency at Various  $I_{DLNA}$  Values,  $R_{FIN} = -20$  dBm, LO = 2 dBm, IF = 500 MHz,  $V_{DLNA} = 3$  V

13141-026



13141-027

Figure 27. Input IP2 vs. RF Frequency at Various Temperatures,  $R_{FIN} = -20$  dBm, LO = 2 dBm, IF = 500 MHz,  $V_{DLNA} = 4$  V

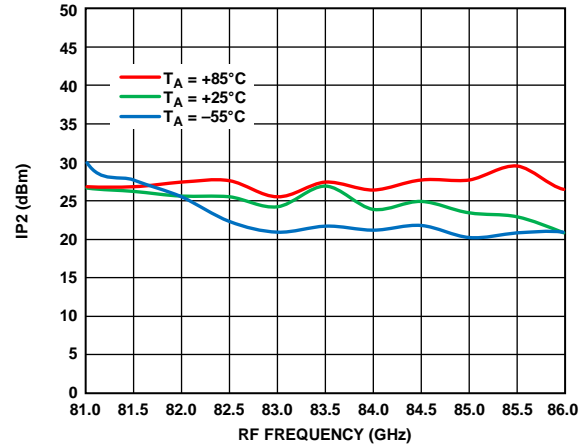

13141-030

Figure 30. Input IP2 vs. RF Frequency at Various Temperatures,  $R_{FIN} = -20$  dBm, LO = 2 dBm, IF = 500 MHz,  $V_{DLNA} = 3$  V

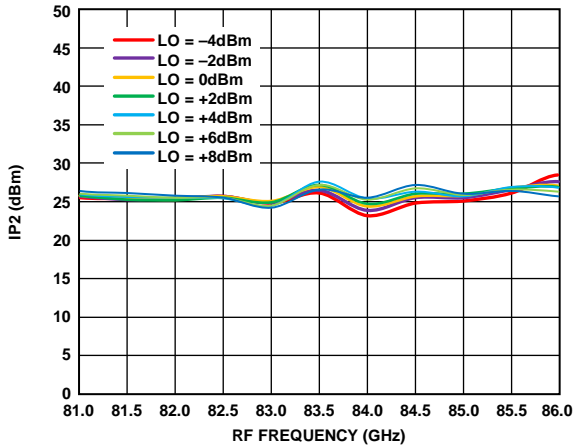

13141-028

Figure 28. Input IP2 vs. RF Frequency at Various LO Powers,  $R_{FIN} = -20$  dBm, IF = 500 MHz,  $V_{DLNA} = 4$  V

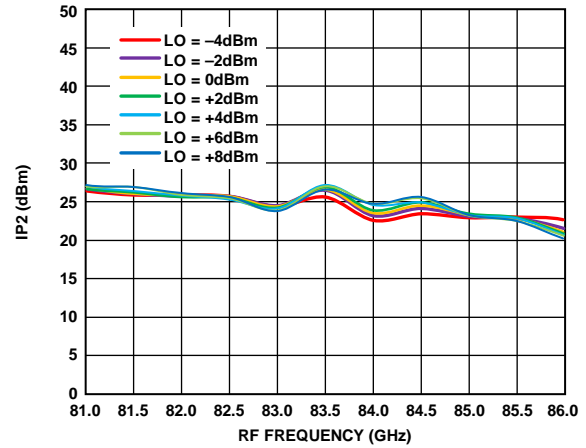

13141-031

Figure 31. Input IP2 vs. RF Frequency at Various LO Powers,  $R_{FIN} = -20$  dBm, IF = 500 MHz,  $V_{DLNA} = 3$  V

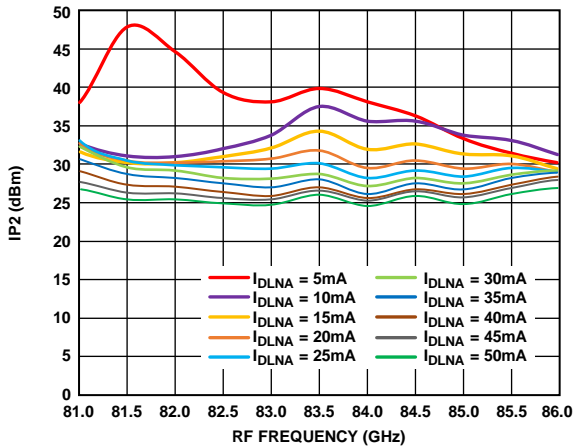

13141-029

Figure 29. Input IP2 vs. RF Frequency at Various  $I_{DLNA}$  Values,  $R_{FIN} = -20$  dBm, LO = 2 dBm, IF = 500 MHz,  $V_{DLNA} = 4$  V

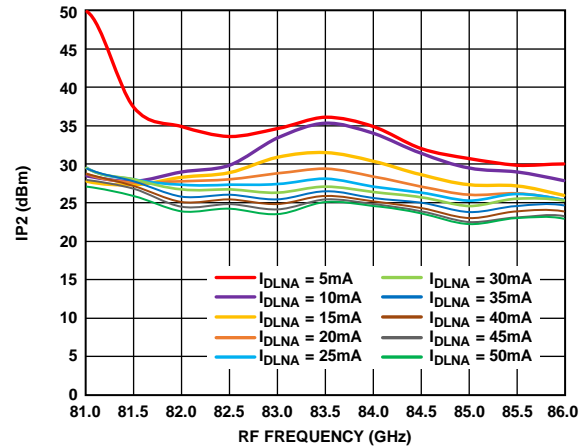

13141-032

Figure 32. Input IP2 vs. RF Frequency at Various  $I_{DLNA}$  Values,  $R_{FIN} = -20$  dBm, LO = 2 dBm, IF = 500 MHz,  $V_{DLNA} = 3$  V

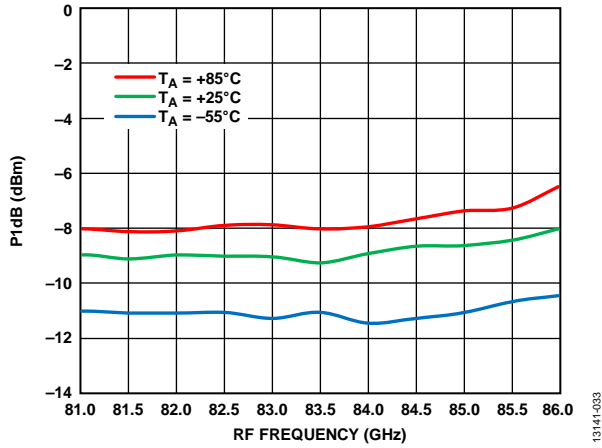

Figure 33. Input P1dB vs. RF Frequency at Various Temperatures, LO = 2 dBm, IF = 500 MHz, V<sub>DLNA</sub> = 4 V

13141-033

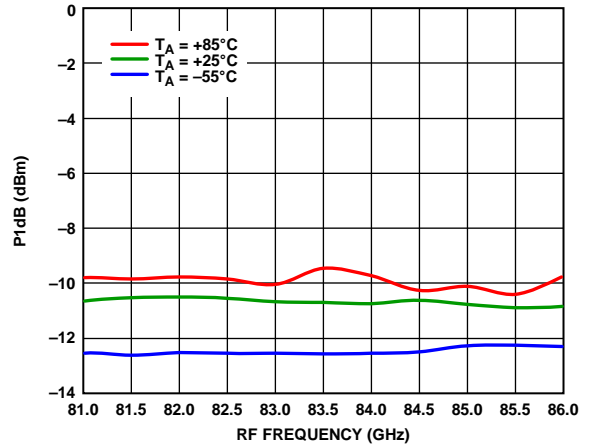

Figure 36. Input P1dB vs. RF Frequency at Various Temperatures, LO = 2 dBm, IF = 500 MHz, V<sub>DLNA</sub> = 3 V

13141-036

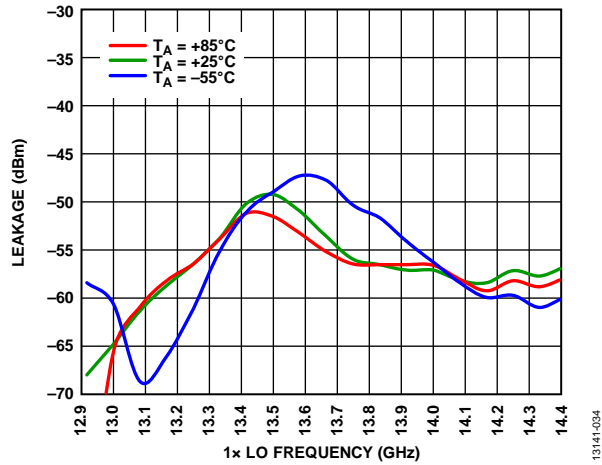

Figure 34. 1x LO Leakage at IFOUT vs. 1x LO Frequency at Various Temperatures, LO = 2 dBm, V<sub>DLNA</sub> = 3 V

13141-034

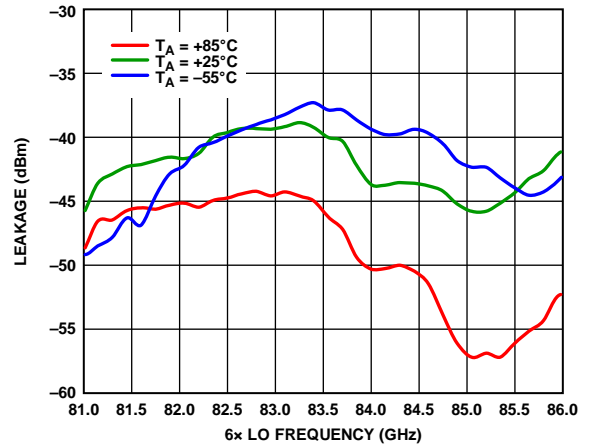

Figure 37. 6x LO Leakage at RFIN vs. 6x LO Frequency at Various Temperatures, LO = 2 dBm, V<sub>DLNA</sub> = 3 V

13141-037

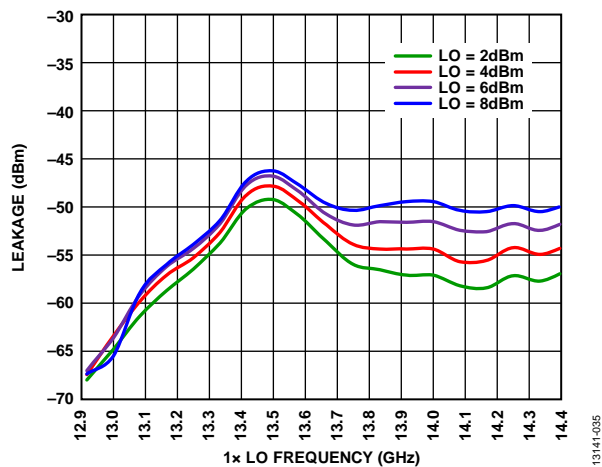

Figure 35. 1x LO Leakage at IFOUT vs. 1x LO Frequency at Various LO Powers, V<sub>DLNA</sub> = 3 V

13141-035

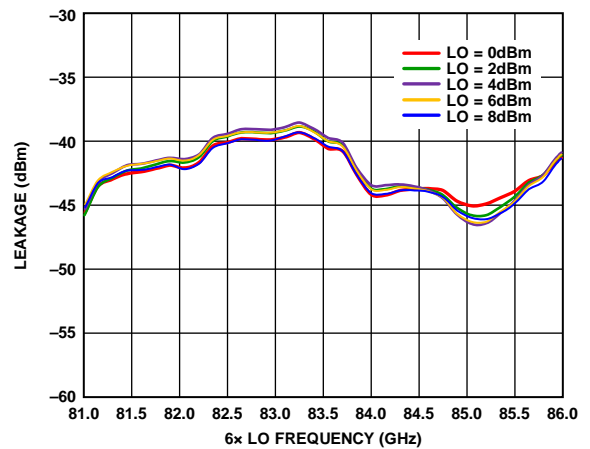
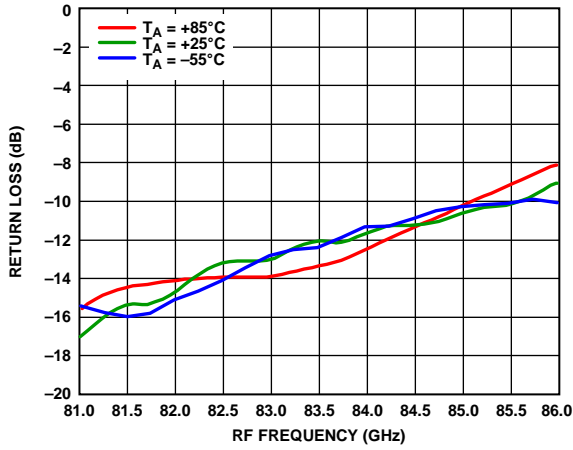

Figure 38. 6x LO Leakage at RFIN vs. 6x LO Frequency at Various LO Powers, V<sub>DLNA</sub> = 3 V

13141-038



13141-039

Figure 39. RF Return Loss vs. RF Frequency at Various Temperatures, LO = 2 dBm, LO = 12 GHz,  $V_{DLNA} = 4 V$

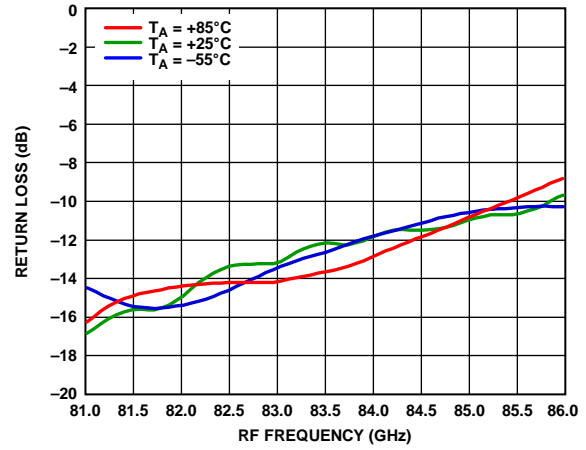

13141-042

Figure 42. RF Return Loss vs. RF Frequency at Various Temperatures, LO = 2 dBm, LO = 12 GHz,  $V_{DLNA} = 3 V$

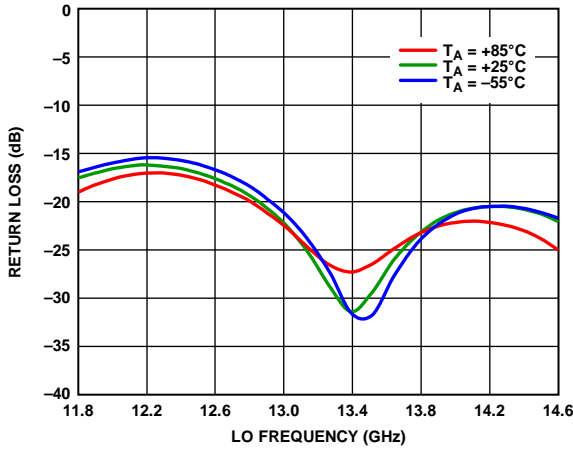

13141-040

Figure 40. LO Return Loss vs. LO Frequency at Various Temperatures, LO = 2 dBm,  $V_{DLNA} = 3 V$

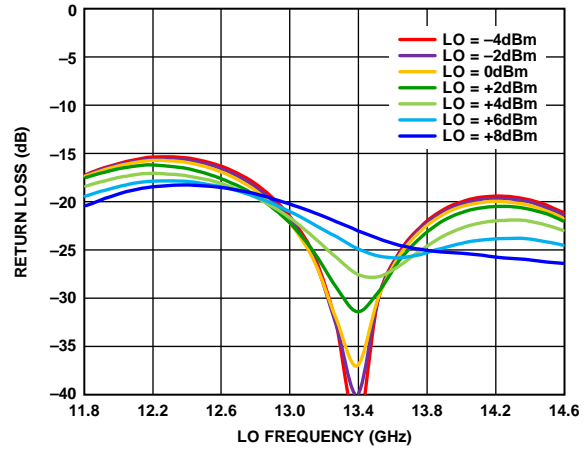

13141-043

Figure 43. LO Return Loss vs. LO Frequency at Various LO Powers,  $V_{DLNA} = 3 V$

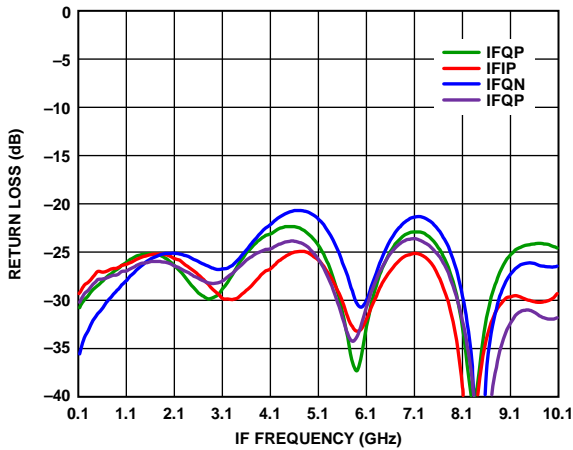

13141-041

Figure 41. IF Return Loss vs. IF Frequency, LO = 2 dBm at 12 GHz,  $V_{DLNA} = 3 V$

UPPER SIDEBAND SELECTED, IF = 1000 MHz

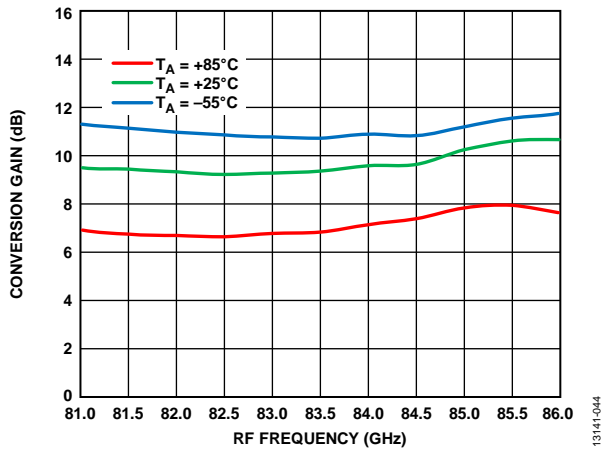

Figure 44. Conversion Gain vs. RF Frequency at Various Temperatures,  $R_{FIN} = -20$  dBm,  $LO = 2$  dBm,  $IF = 1000$  MHz,  $V_{DLNA} = 4$  V

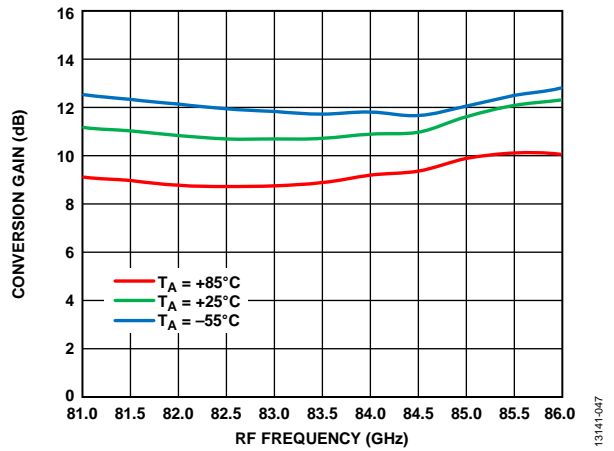

Figure 47. Conversion Gain vs. RF Frequency at Various Temperatures,  $R_{FIN} = -20$  dBm,  $LO = 2$  dBm,  $IF = 1000$  MHz,  $V_{DLNA} = 3$  V

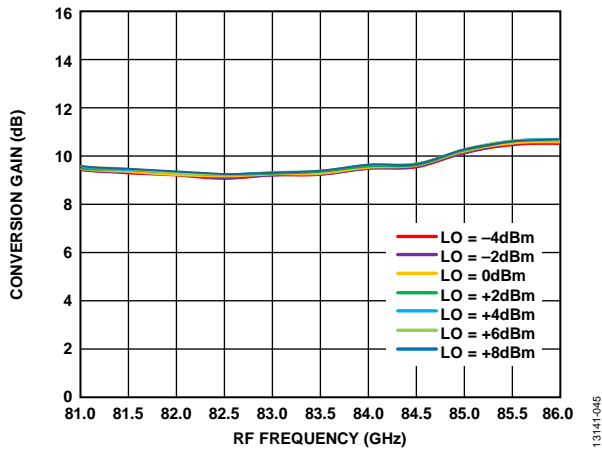

Figure 45. Conversion Gain vs. RF Frequency at Various LO Powers,  $R_{FIN} = -20$  dBm,  $IF = 1000$  MHz,  $V_{DLNA} = 4$  V

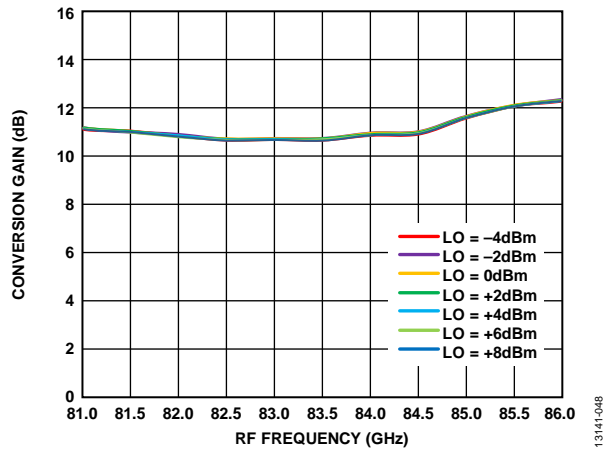

Figure 48. Conversion Gain vs. RF Frequency at Various LO Powers,  $R_{FIN} = -20$  dBm,  $IF = 1000$  MHz,  $V_{DLNA} = 3$  V

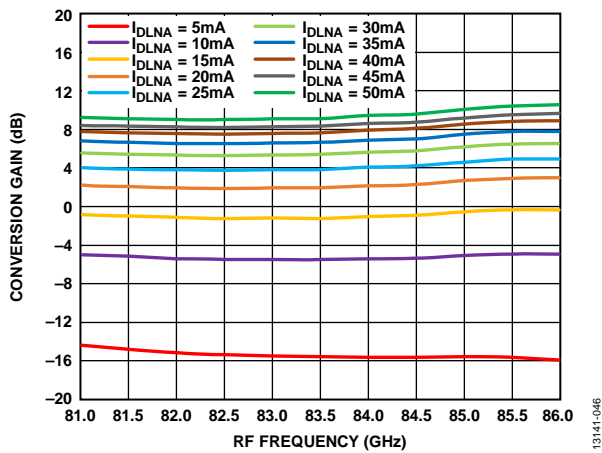

Figure 46. Conversion Gain vs. RF Frequency at Various  $I_{DLNA}$  Values,  $R_{FIN} = -20$  dBm,  $LO = 2$  dBm,  $IF = 1000$  MHz,  $V_{DLNA} = 4$  V

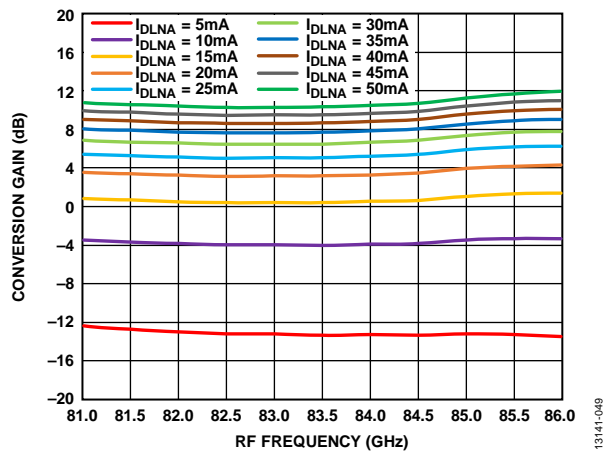

Figure 49. Conversion Gain vs. RF Frequency at Various  $I_{DLNA}$  Values,  $R_{FIN} = -20$  dBm,  $LO = 2$  dBm,  $IF = 1000$  MHz,  $V_{DLNA} = 3$  V

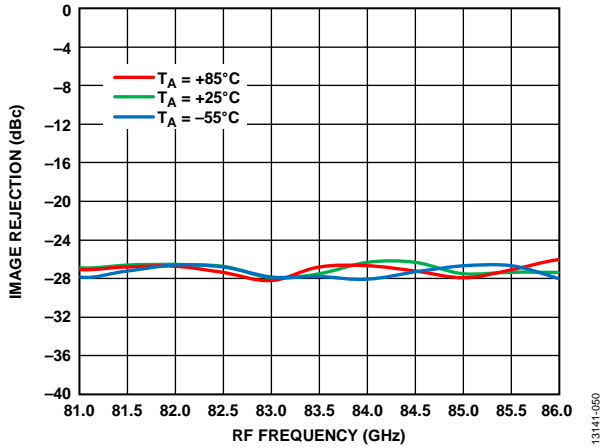

Figure 50. Image Rejection vs. RF Frequency at Various Temperatures,  $R_{FIN} = -20$  dBm,  $LO = 2$  dBm,  $IF = 1000$  MHz,  $V_{DLNA} = 4$  V

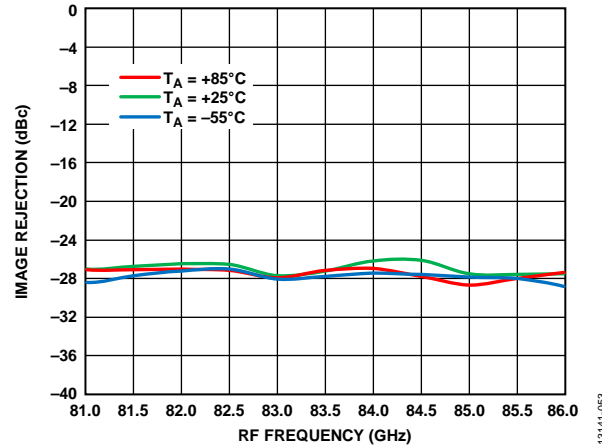

Figure 53. Image Rejection vs. RF Frequency at Various Temperatures,  $R_{FIN} = -20$  dBm,  $LO = 2$  dBm,  $IF = 1000$  MHz,  $V_{DLNA} = 3$  V

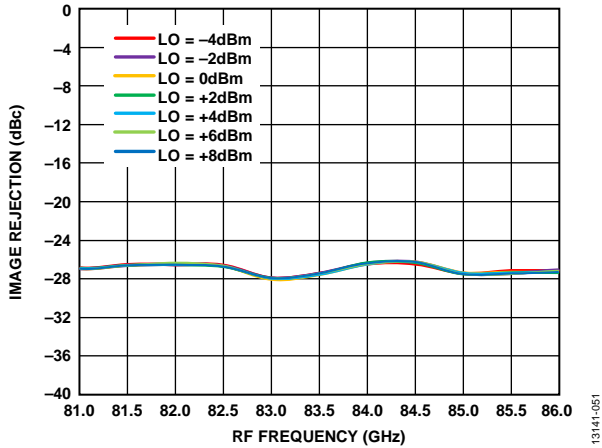

Figure 51. Image Rejection vs. RF Frequency at Various LO Powers,  $R_{FIN} = -20$  dBm,  $IF = 1000$  MHz,  $V_{DLNA} = 4$  V

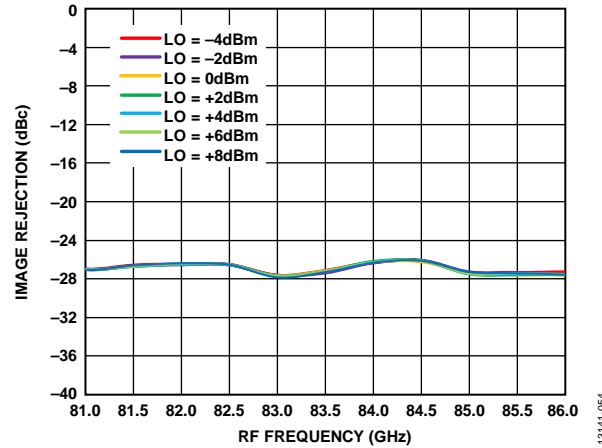

Figure 54. Image Rejection vs. RF Frequency at Various LO Powers,  $R_{FIN} = -20$  dBm,  $IF = 1000$  MHz,  $V_{DLNA} = 3$  V

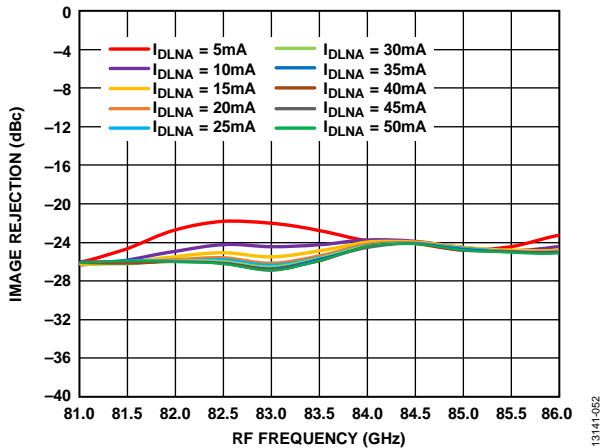

Figure 52. Image Rejection vs. RF Frequency at Various  $I_{DLNA}$  Values,  $R_{FIN} = -20$  dBm,  $LO = 2$  dBm,  $IF = 1000$  MHz,  $V_{DLNA} = 4$  V

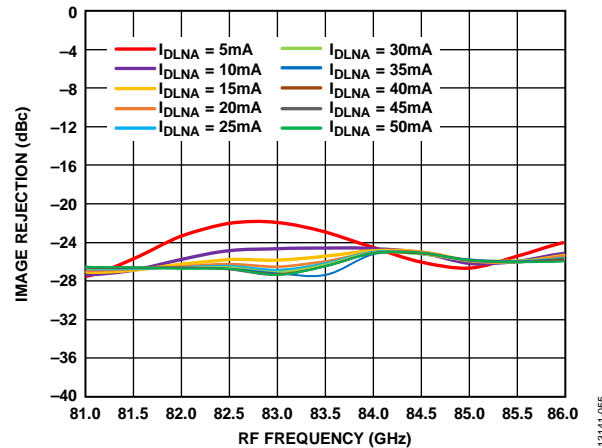

Figure 55. Image Rejection vs. RF Frequency at Various  $I_{DLNA}$  Values,  $R_{FIN} = -20$  dBm,  $LO = 2$  dBm,  $IF = 1000$  MHz,  $V_{DLNA} = 3$  V

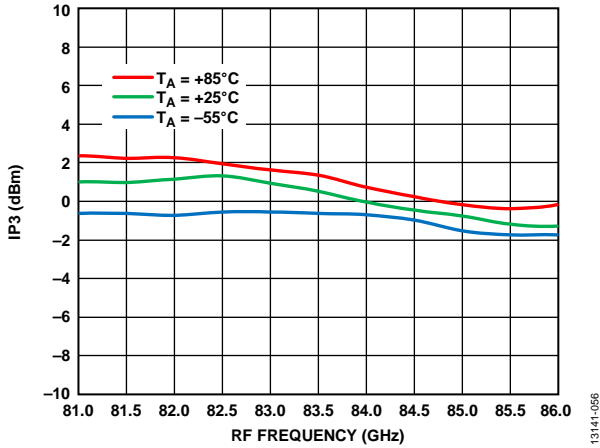

Figure 56. Input IP3 vs. RF Frequency at Various Temperatures,  $R_{FIN} = -20\text{ dBm}$ ,  $LO = 2\text{ dBm}$ ,  $IF = 1000\text{ MHz}$ ,  $V_{DLNA} = 4\text{ V}$

13141-0566

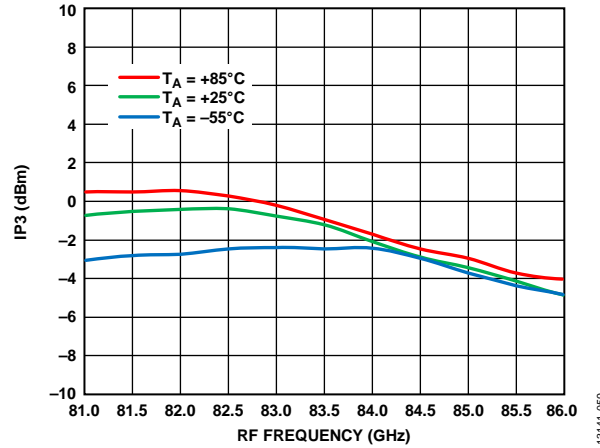

Figure 59. Input IP3 vs. RF Frequency at Various Temperatures,  $R_{FIN} = -20\text{ dBm}$ ,  $LO = 2\text{ dBm}$ ,  $IF = 1000\text{ MHz}$ ,  $V_{DLNA} = 3\text{ V}$

13141-0569

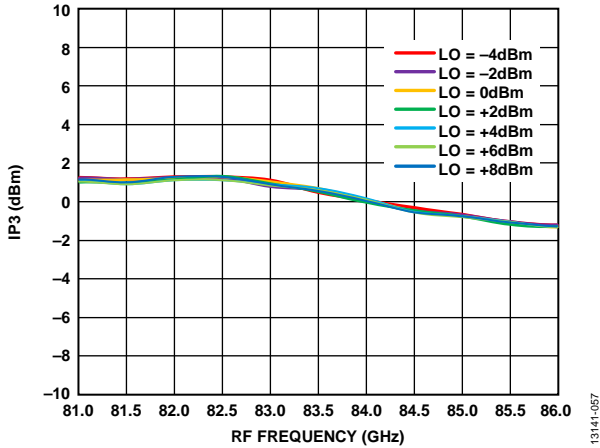

Figure 57. Input IP3 vs. RF Frequency at Various LO Powers,  $R_{FIN} = -20\text{ dBm}$ ,  $IF = 1000\text{ MHz}$ ,  $V_{DLNA} = 4\text{ V}$

13141-057

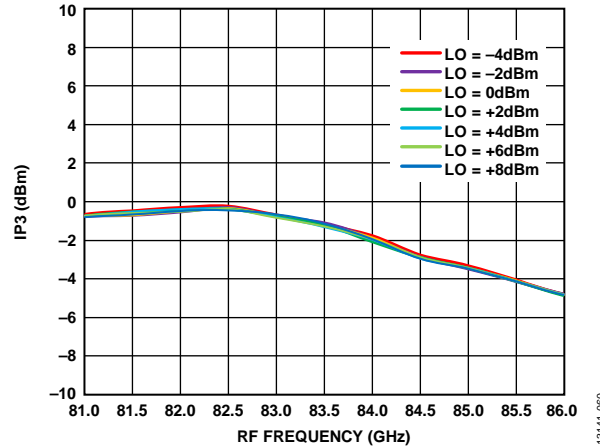

Figure 60. Input IP3 vs. RF Frequency at Various LO Powers,  $R_{FIN} = -20\text{ dBm}$ ,  $IF = 1000\text{ MHz}$ ,  $V_{DLNA} = 3\text{ V}$

13141-060

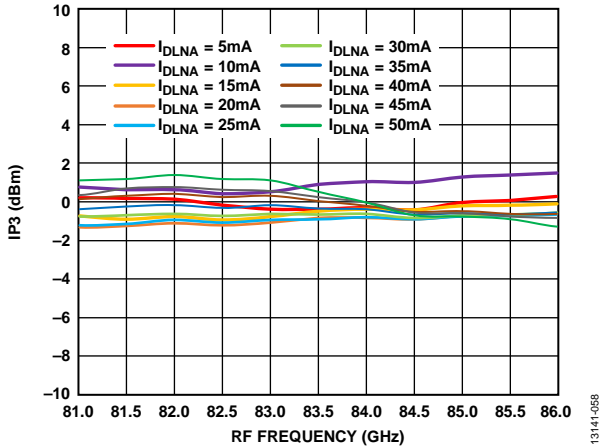

Figure 58. Input IP3 vs. RF Frequency at Various  $I_{DLNA}$  Values,  $R_{FIN} = -20\text{ dBm}$ ,  $LO = 2\text{ dBm}$ ,  $IF = 1000\text{ MHz}$ ,  $V_{DLNA} = 4\text{ V}$

13141-0588

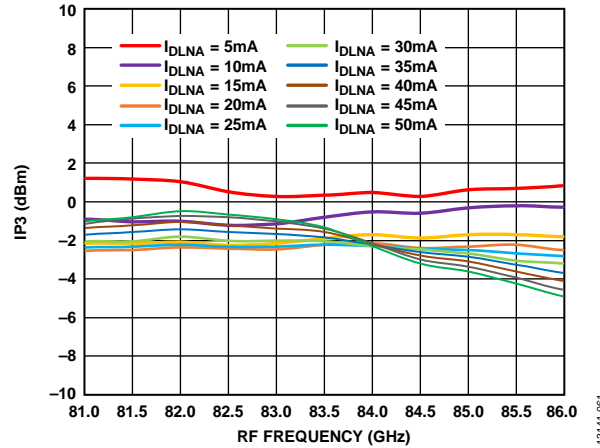

Figure 61. Input IP3 vs. RF Frequency at Various  $I_{DLNA}$  Values,  $R_{FIN} = -20\text{ dBm}$ ,  $LO = 2\text{ dBm}$ ,  $IF = 1000\text{ MHz}$ ,  $V_{DLNA} = 3\text{ V}$

13141-061

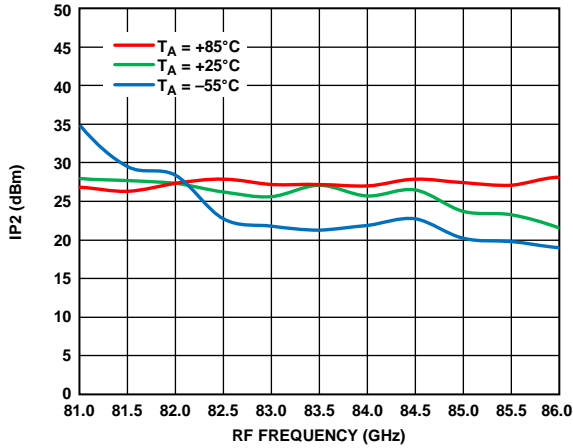

Figure 62. Input IP2 vs. RF Frequency at Various Temperatures,  $R_{FIN} = -20$  dBm, LO = 2 dBm, IF = 1000 MHz,  $V_{DLNA} = 4$  V

13141-062

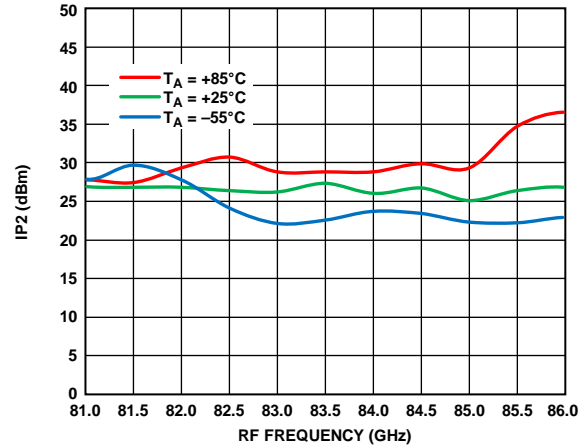

Figure 65. Input IP2 vs. RF Frequency at Various Temperatures,  $R_{FIN} = -20$  dBm, LO = 2 dBm, IF = 1000 MHz,  $V_{DLNA} = 3$  V

13141-065

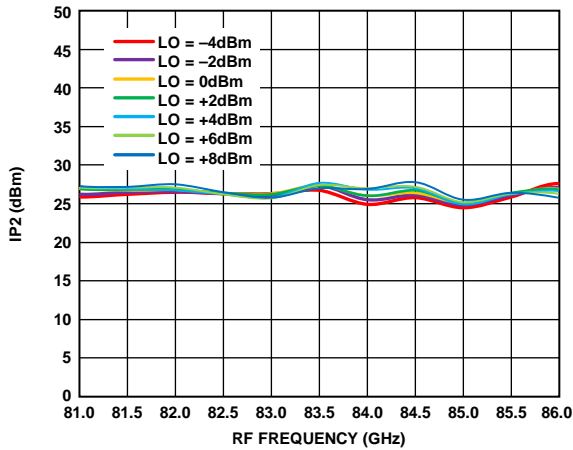

Figure 63. Input IP2 vs. RF Frequency at Various LO Powers,  $R_{FIN} = -20$  dBm, IF = 1000 MHz,  $V_{DLNA} = 4$  V

13141-063

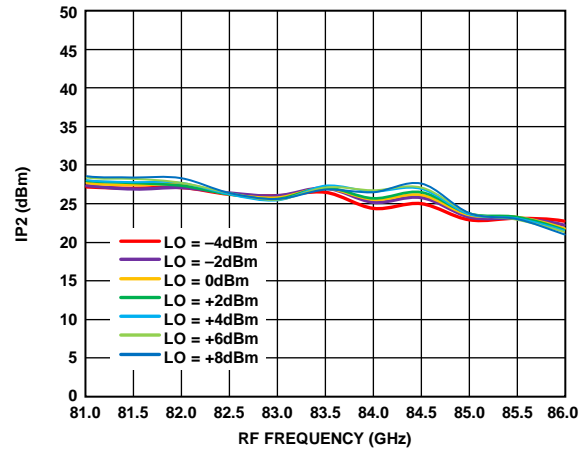

Figure 66. Input IP2 vs. RF Frequency at Various LO Powers,  $R_{FIN} = -20$  dBm, IF = 1000 MHz,  $V_{DLNA} = 3$  V

13141-066

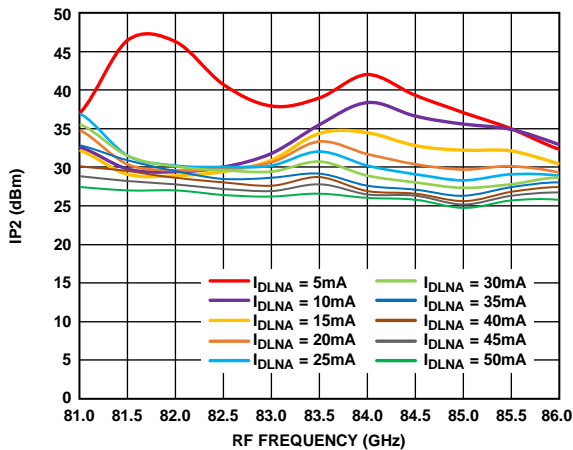

Figure 64. Input IP2 vs. RF Frequency at Various  $I_{DLNA}$  Values,  $R_{FIN} = -20$  dBm, LO = 2 dBm, IF = 1000 MHz,  $V_{DLNA} = 4$  V

13141-064

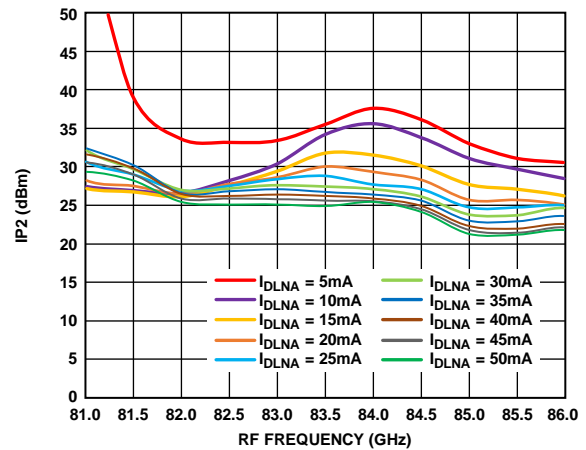

Figure 67. Input IP2 vs. RF Frequency at Various  $I_{DLNA}$  Values,  $R_{FIN} = -20$  dBm, LO = 2 dBm, IF = 1000 MHz,  $V_{DLNA} = 3$  V

13141-067



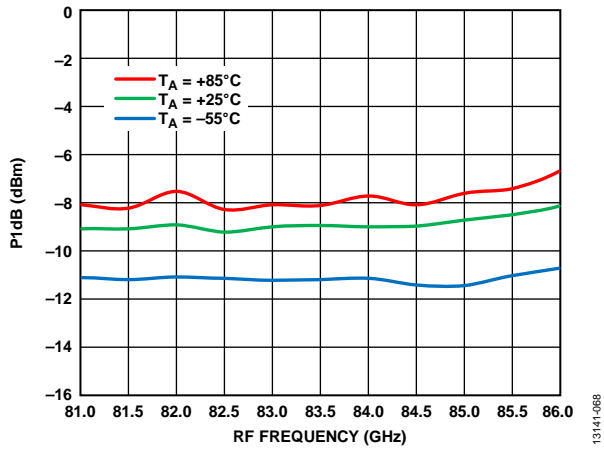

Figure 68. Input P1dB vs. RF Frequency at Various Temperatures, LO = 2 dBm, IF = 1000 MHz, V<sub>DLNA</sub> = 4 V

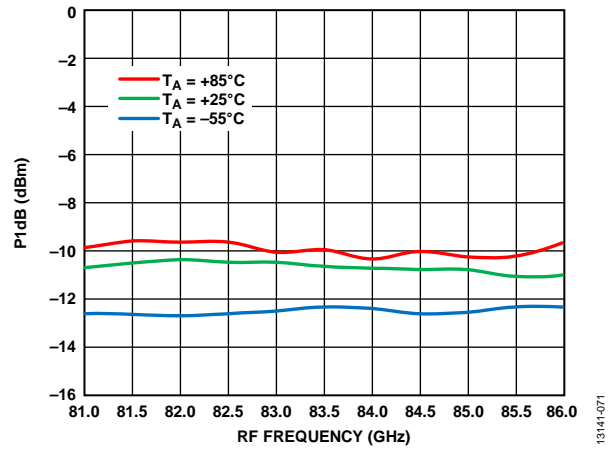

Figure 69. Input P1dB vs. RF Frequency at Various Temperatures, LO = 2 dBm, IF = 1000 MHz, V<sub>DLNA</sub> = 3 V

13141-068

13141-071

UPPER SIDEBAND SELECTED, IF = 2000 MHz

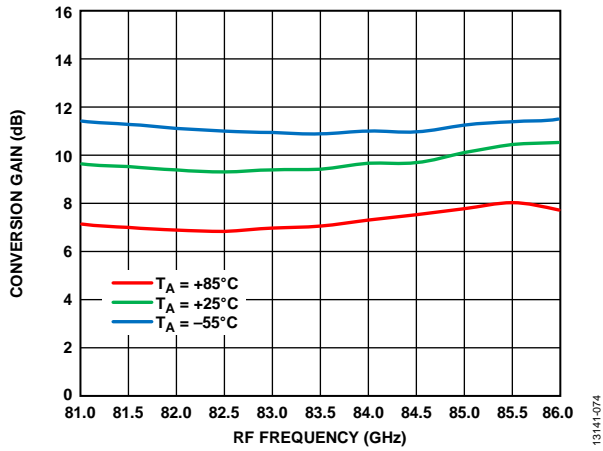

Figure 70. Conversion Gain vs. RF Frequency at Various Temperatures, RFIN = -20 dBm, LO = 2 dBm, IF = 2000 MHz, VDLNA = 4 V

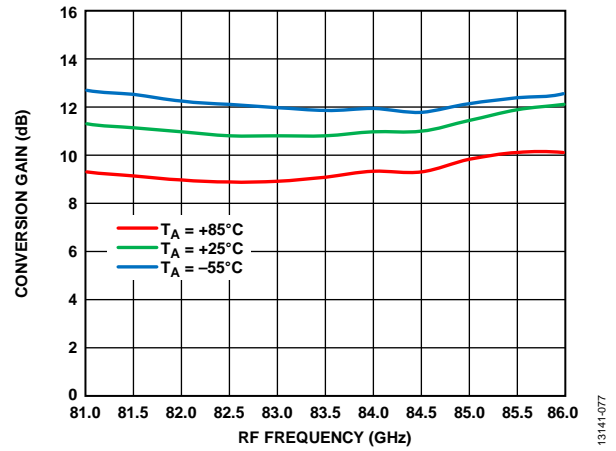

Figure 73. Conversion Gain vs. RF Frequency at Various Temperatures, RFIN = -20 dBm, LO = 2 dBm, IF = 2000 MHz, VDLNA = 3 V

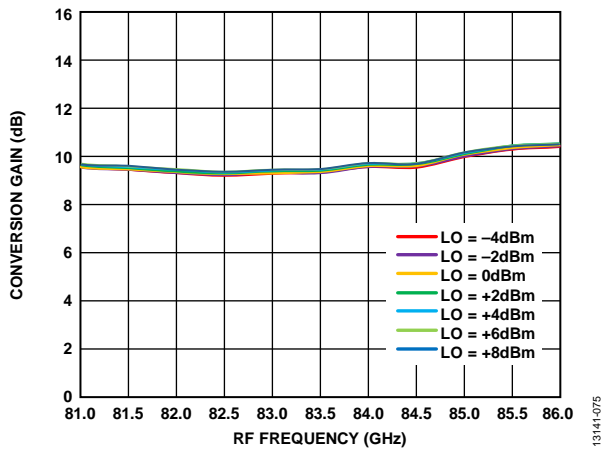

Figure 71. Conversion Gain vs. RF Frequency at Various LO Powers, RFIN = -20 dBm, IF = 2000 MHz, VDLNA = 4 V

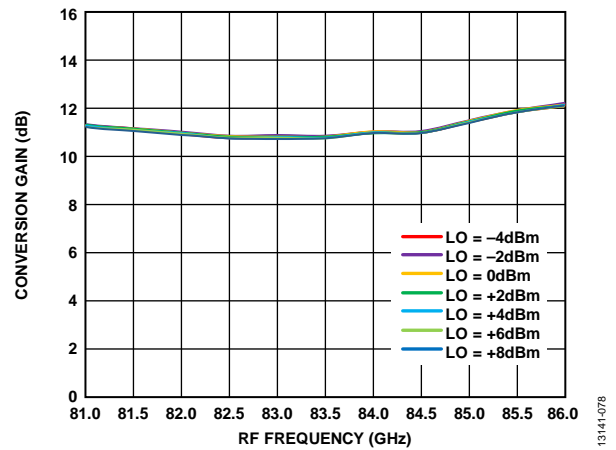

Figure 74. Conversion Gain vs. RF Frequency at Various LO Powers, RFIN = -20 dBm, IF = 2000 MHz, VDLNA = 3 V

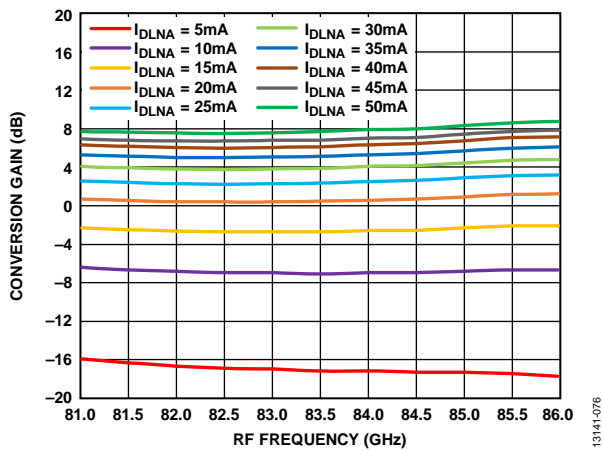

Figure 72. Conversion Gain vs. RF Frequency at Various IDLNA Values, RFIN = -20 dBm, LO = 2 dBm, IF = 2000 MHz, VDLNA = 4 V

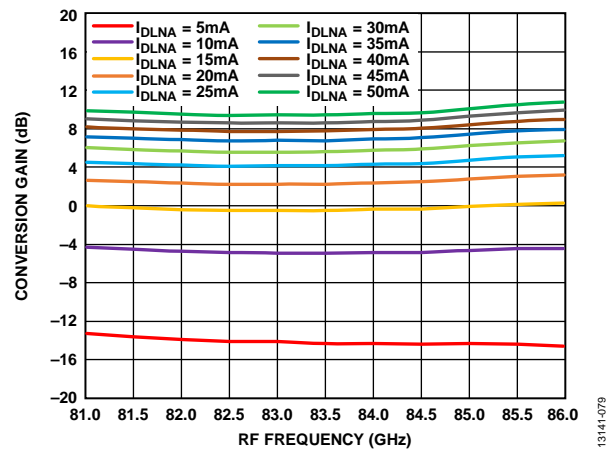

Figure 75. Conversion Gain vs. RF Frequency at Various IDLNA Values, RFIN = -20 dBm, LO = 2 dBm, IF = 2000 MHz, VDLNA = 3 V

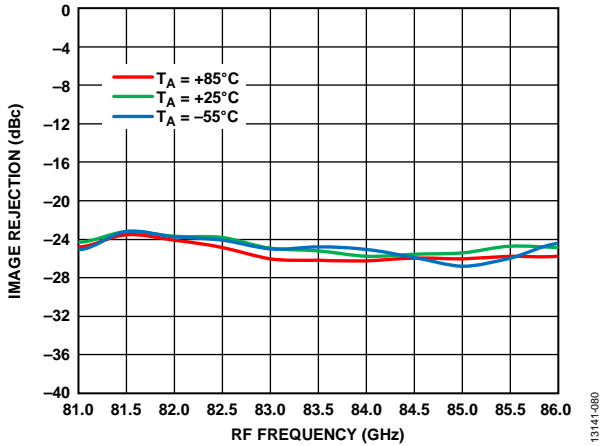

Figure 76. Image Rejection vs. RF Frequency at Various Temperatures,  $R_{FIN} = -20$  dBm,  $L_O = 2$  dBm,  $I_F = 2000$  MHz,  $V_{DLNA} = 4$  V

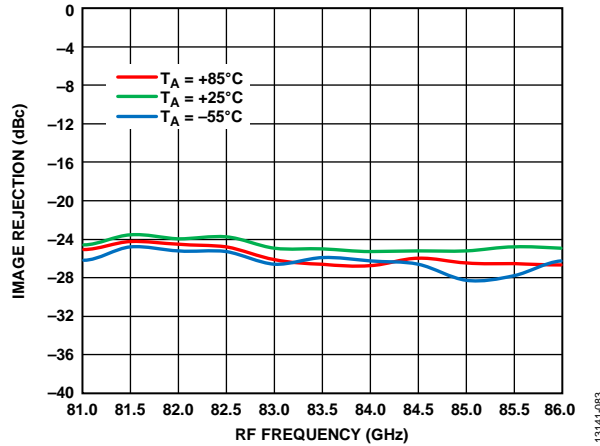

Figure 79. Image Rejection vs. RF Frequency at Various Temperatures,  $R_{FIN} = -20$  dBm,  $L_O = 2$  dBm,  $I_F = 2000$  MHz,  $V_{DLNA} = 3$  V

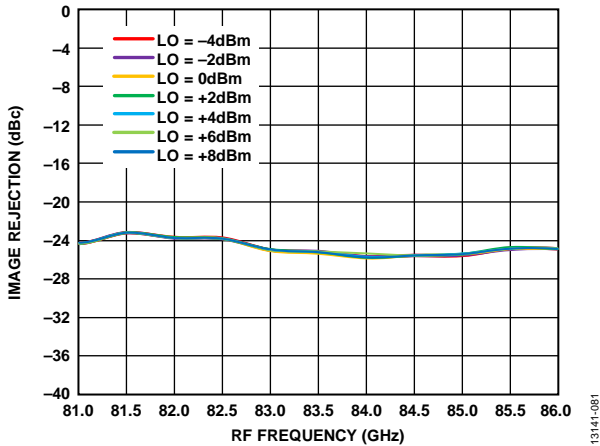

Figure 77. Image Rejection vs. RF Frequency at Various LO Powers,  $R_{FIN} = -20$  dBm,  $I_F = 2000$  MHz,  $V_{DLNA} = 4$  V

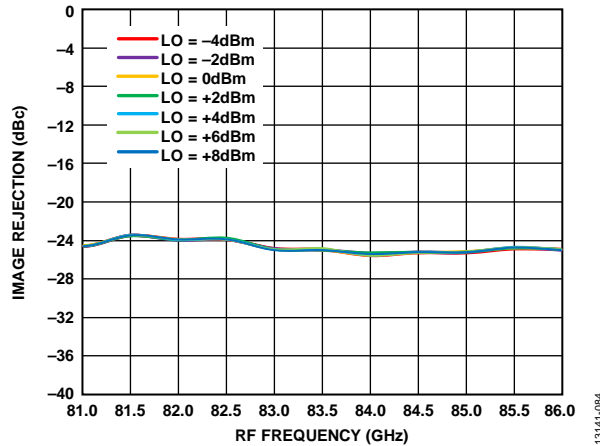

Figure 80. Image Rejection vs. RF Frequency at Various LO Powers,  $R_{FIN} = -20$  dBm,  $I_F = 2000$  MHz,  $V_{DLNA} = 3$  V

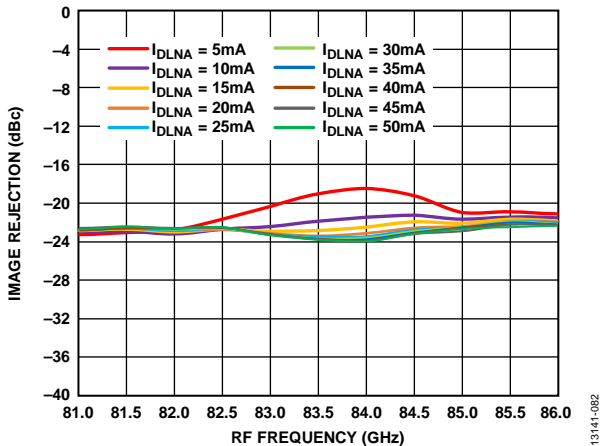

Figure 78. Image Rejection vs. RF Frequency at Various  $I_{DLNA}$  Values,  $R_{FIN} = -20$  dBm,  $L_O = 2$  dBm,  $I_F = 2000$  MHz,  $V_{DLNA} = 4$  V

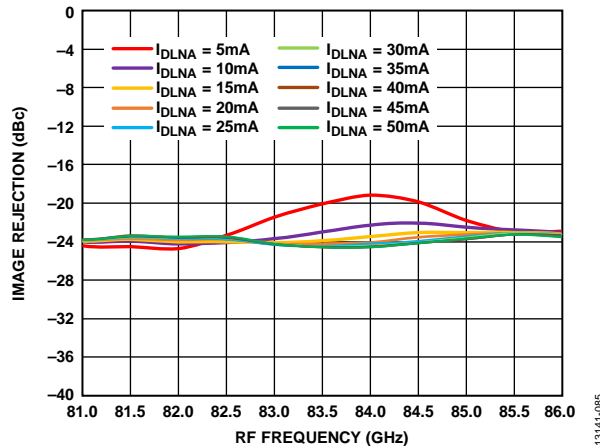

Figure 81. Image Rejection vs. RF Frequency at Various  $I_{DLNA}$  Values,  $R_{FIN} = -20$  dBm,  $L_O = 2$  dBm,  $I_F = 2000$  MHz,  $V_{DLNA} = 3$  V

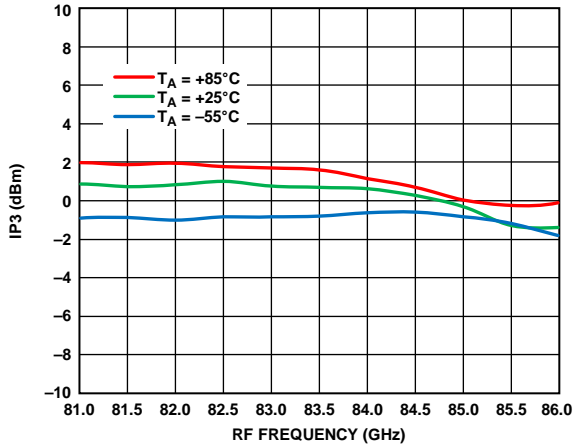

Figure 82. Input IP3 vs. RF Frequency at Various Temperatures,  $R_{FIN} = -20$  dBm, LO = 2 dBm, IF = 2000 MHz,  $V_{DLNA} = 4$  V

13141-086

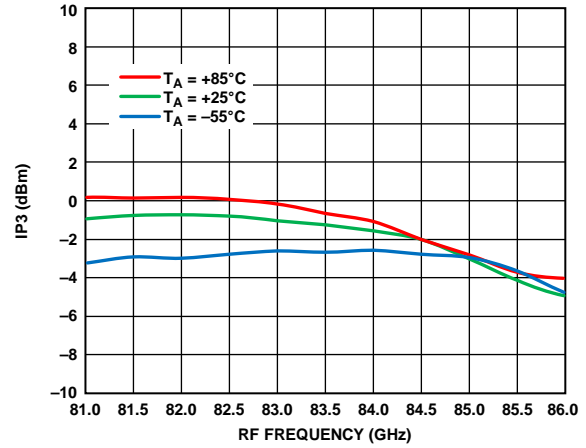

Figure 85. Input IP3 vs. RF Frequency at Various Temperatures,  $R_{FIN} = -20$  dBm, LO = 2 dBm, IF = 2000 MHz,  $V_{DLNA} = 3$  V

13141-089

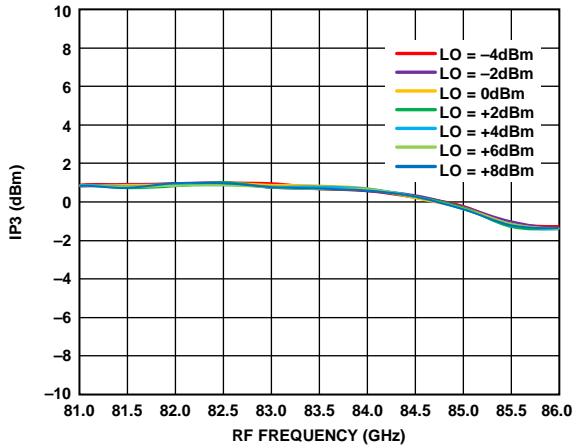

Figure 83. Input IP3 vs. RF Frequency at Various LO Powers,  $R_{FIN} = -20$  dBm, IF = 2000 MHz,  $V_{DLNA} = 4$  V

13141-087

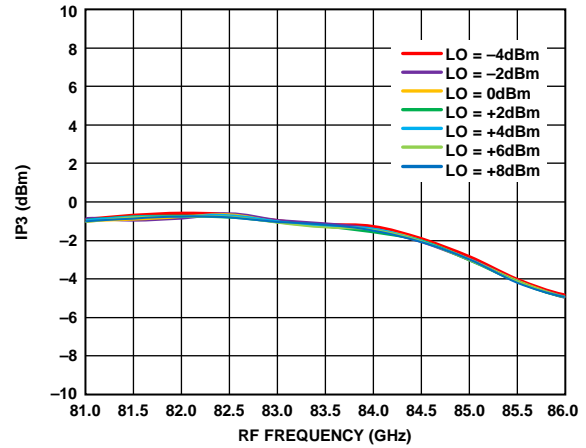

Figure 86. Input IP3 vs. RF Frequency at Various LO Powers,  $R_{FIN} = -20$  dBm, IF = 2000 MHz,  $V_{DLNA} = 3$  V

13141-090

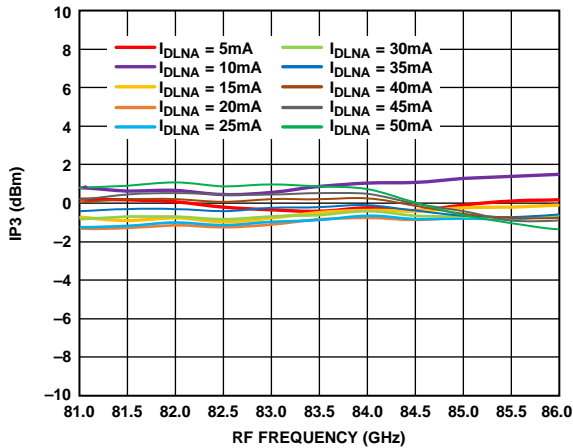

Figure 84. Input IP3 vs. RF Frequency at Various  $I_{DLNA}$  Values,  $R_{FIN} = -20$  dBm, LO = 2 dBm, IF = 2000 MHz,  $V_{DLNA} = 4$  V

13141-088

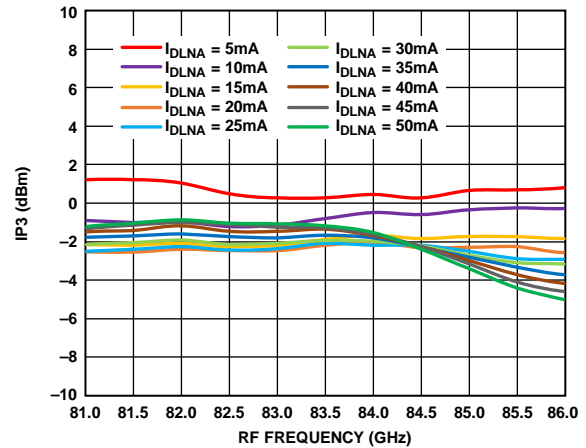

Figure 87. Input IP3 vs. RF Frequency at Various  $I_{DLNA}$  Values,  $R_{FIN} = -20$  dBm, LO = 2 dBm, IF = 2000 MHz,  $V_{DLNA} = 3$  V

13141-091

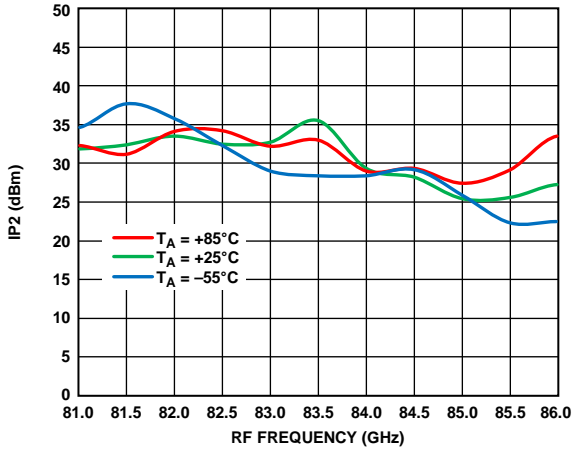

Figure 88. Input IP2 vs. RF Frequency at Various Temperatures,  $R_{FIN} = -20$  dBm,  $LO = 2$  dBm,  $IF = 2000$  MHz,  $V_{DLNA} = 4$  V

13141-082

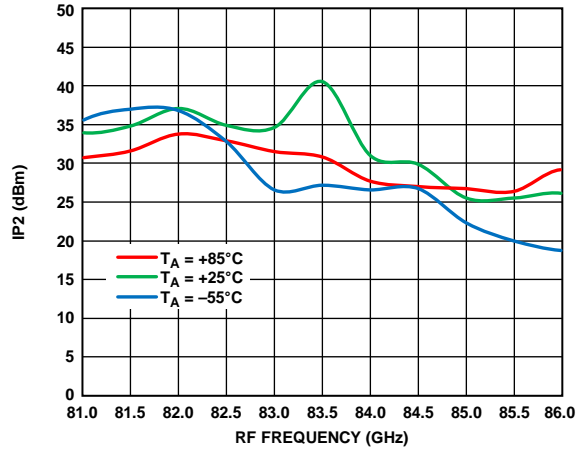

Figure 91. Input IP2 vs. RF Frequency at Various Temperatures,  $R_{FIN} = -20$  dBm,  $LO = 2$  dBm,  $IF = 2000$  MHz,  $V_{DLNA} = 3$  V

13141-085

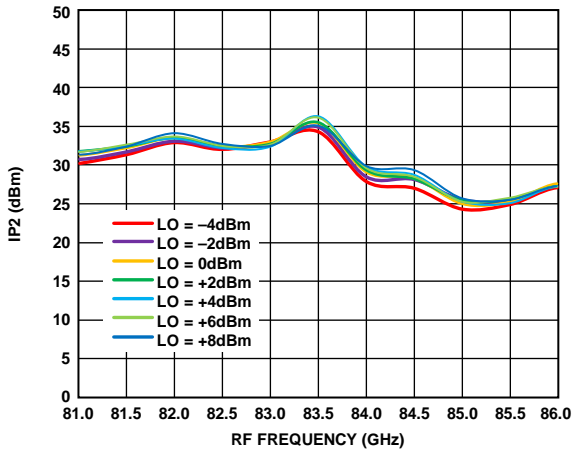

Figure 89. Input IP2 vs. RF Frequency at Various LO Powers,  $R_{FIN} = -20$  dBm,  $IF = 2000$  MHz,  $V_{DLNA} = 4$  V

13141-083

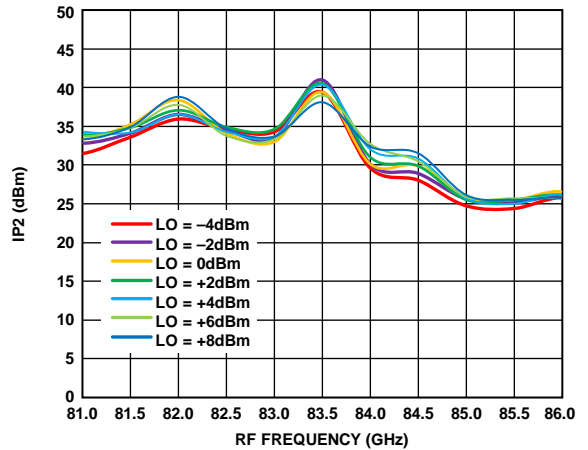

Figure 92. Input IP2 vs. RF Frequency at Various LO Powers,  $R_{FIN} = -20$  dBm,  $IF = 2000$  MHz,  $V_{DLNA} = 3$  V

13141-086

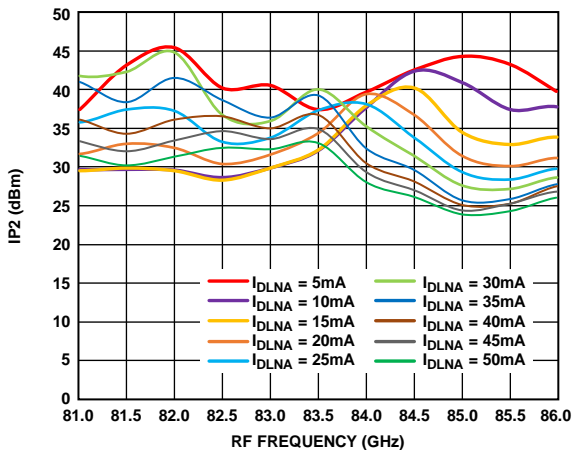

Figure 90. Input IP2 vs. RF Frequency at Various  $I_{DLNA}$  Values,  $R_{FIN} = -20$  dBm,  $LO = 2$  dBm,  $IF = 2000$  MHz,  $V_{DLNA} = 4$  V

13141-084

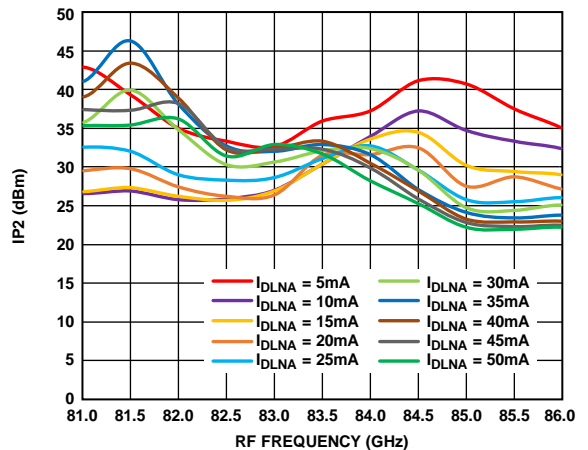

Figure 93. Input IP2 vs. RF Frequency at Various  $I_{DLNA}$  Values,  $R_{FIN} = -20$  dBm,  $LO = 2$  dBm,  $IF = 2000$  MHz,  $V_{DLNA} = 3$  V

13141-087

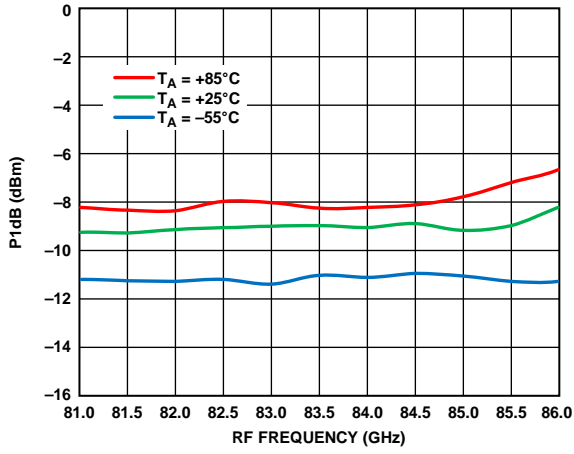

Figure 94. Input P1dB vs. RF Frequency at Various Temperatures, LO = 2 dBm, IF = 2000 MHz, V<sub>DLNA</sub> = 4 V

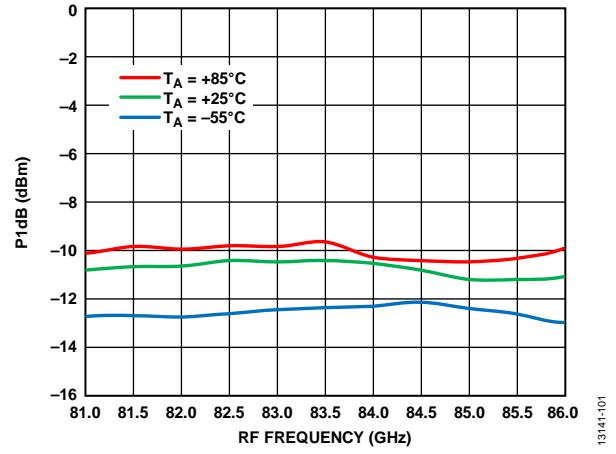

Figure 95. Input P1dB vs. RF Frequency at Various Temperatures, LO = 2 dBm, IF = 2000 MHz, V<sub>DLNA</sub> = 3 V

13141-098

13141-101

**NOISE FIGURE PERFORMANCE WITH UPPER SIDEBAND SELECTED**

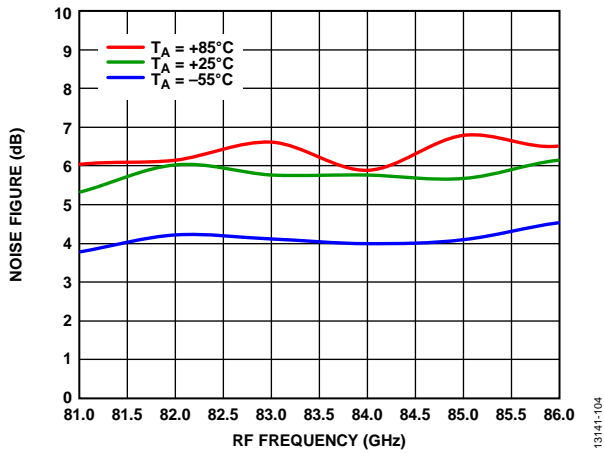

Figure 96. Noise Figure vs. RF Frequency at Various Temperatures, LO = 2 dBm, IF = 500 MHz, V<sub>DLNA</sub> = 3 V

13141-104

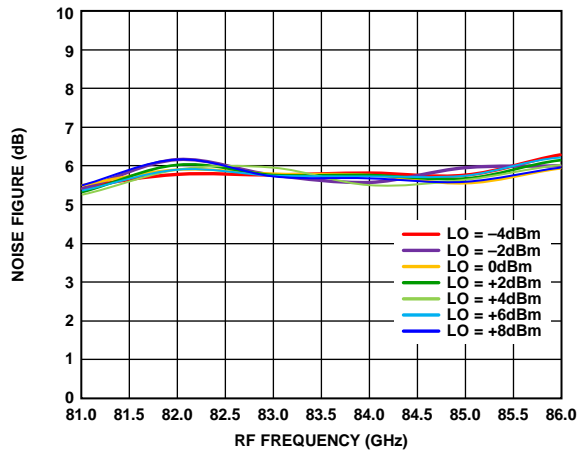

Figure 99. Noise Figure vs. RF Frequency at Various LO Powers, IF = 500 MHz, V<sub>DLNA</sub> = 3 V

13141-107

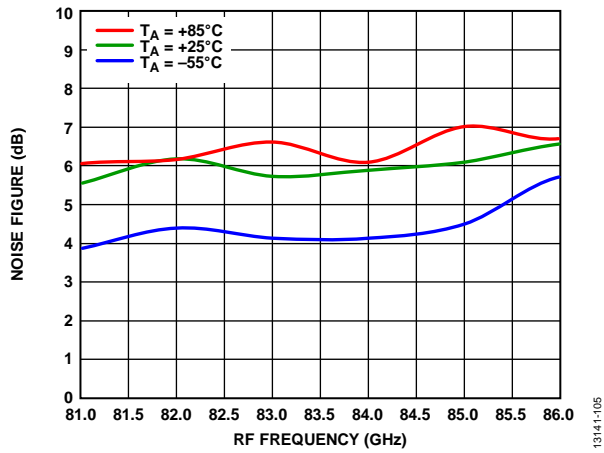

Figure 97. Noise Figure vs. RF Frequency at Various Temperatures, LO = 2 dBm, IF = 1000 MHz, V<sub>DLNA</sub> = 3 V

13141-105

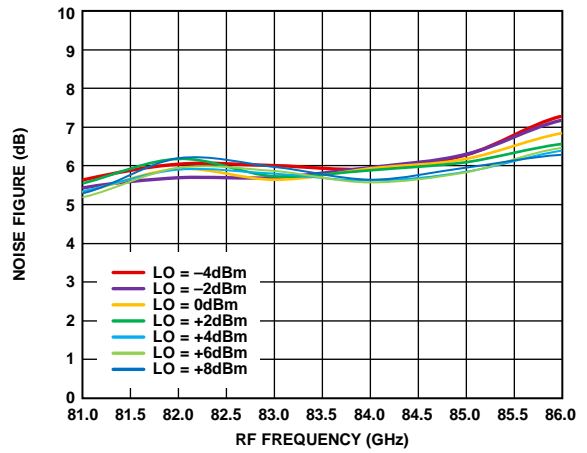

Figure 100. Noise Figure vs. RF Frequency at Various LO Powers, IF = 1000 MHz, V<sub>DLNA</sub> = 3 V

13141-108

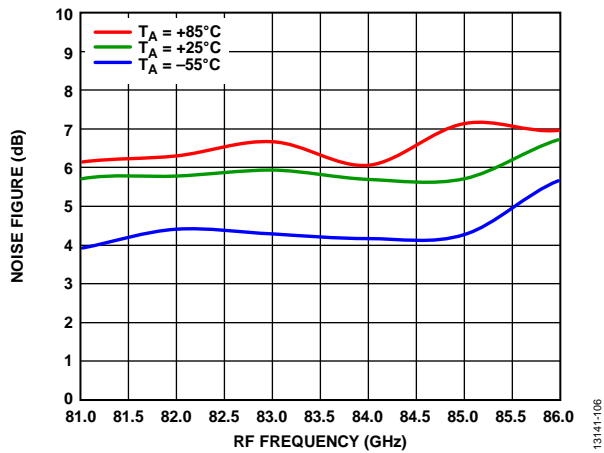

Figure 98. Noise Figure vs. RF Frequency at Various Temperatures, LO = 2 dBm, IF = 2000 MHz, V<sub>DLNA</sub> = 3 V

13141-106

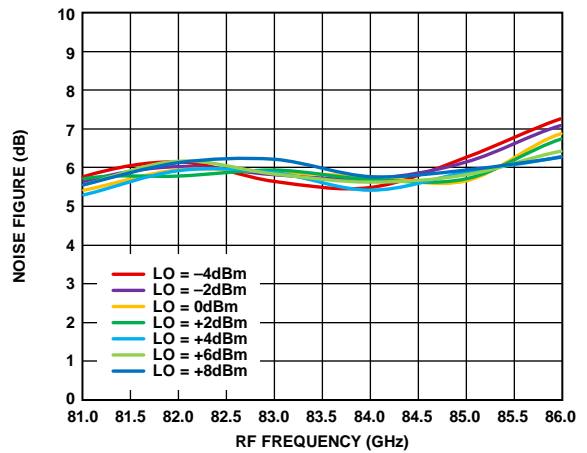

Figure 101. Noise Figure vs. RF Frequency at Various LO Powers, IF = 2000 MHz, V<sub>DLNA</sub> = 3 V

13141-109

AMPLITUDE BALANCE PERFORMANCE WITH UPPER SIDEBAND SELECTED

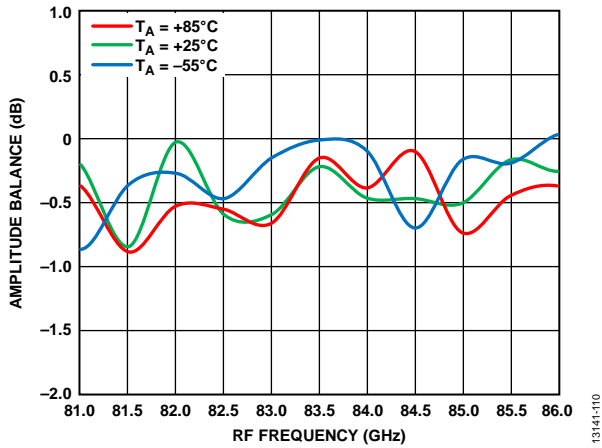

Figure 102. Amplitude Balance vs. RF Frequency at Various Temperatures, RFIN = -20 dBm, LO = 2 dBm, IF = 500 MHz, VDLNA = 4 V

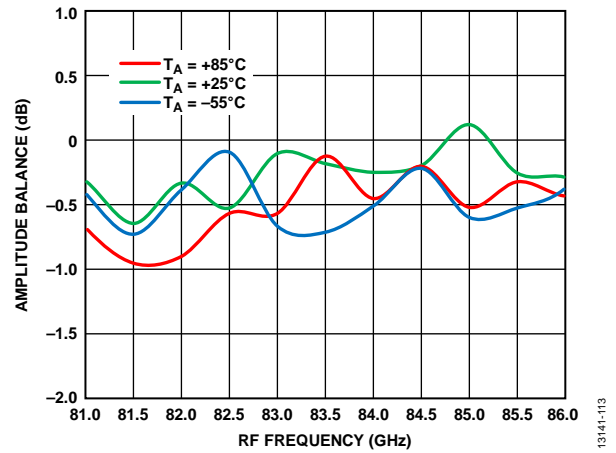

Figure 105. Amplitude Balance vs. RF Frequency at Various Temperatures, RFIN = -20 dBm, LO = 2 dBm, IF = 500 MHz, VDLNA = 3 V

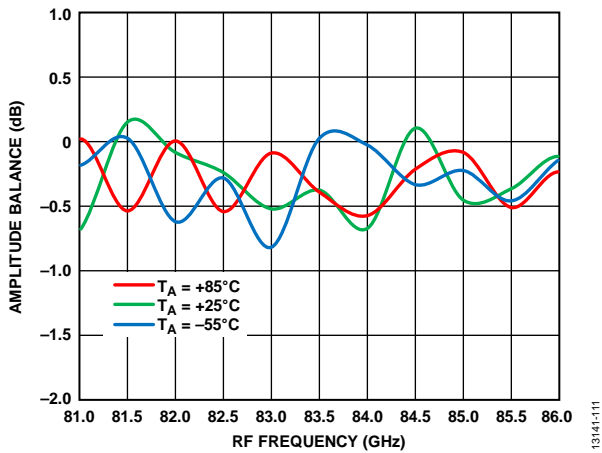

Figure 103. Amplitude Balance vs. RF Frequency at Various Temperatures, RFIN = -20 dBm, LO = 2 dBm, IF = 1000 MHz, VDLNA = 4 V

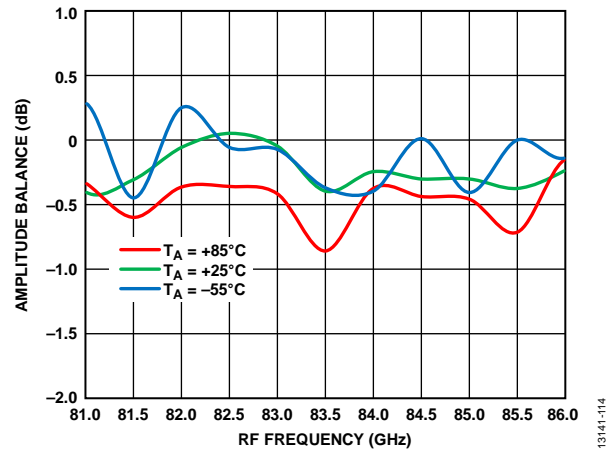

Figure 106. Amplitude Balance vs. RF Frequency at Various Temperatures, RFIN = -20 dBm, LO = 2 dBm, IF = 1000 MHz, VDLNA = 3 V

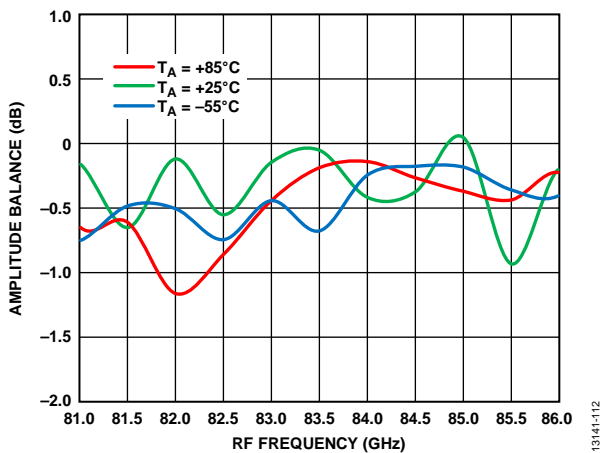

Figure 104. Amplitude Balance vs. RF Frequency at Various Temperatures, RFIN = -20 dBm, LO = 2 dBm, IF = 2000 MHz, VDLNA = 4 V

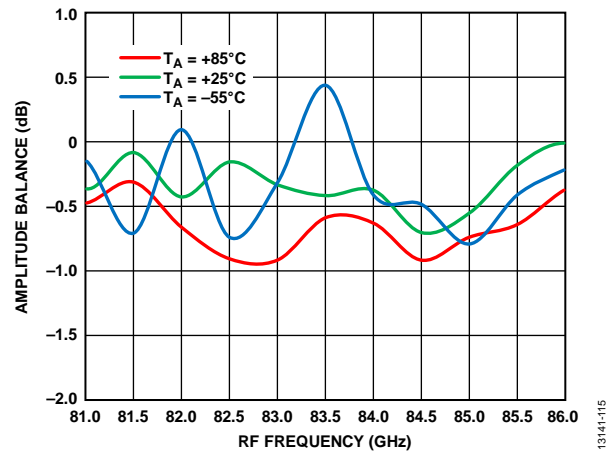

Figure 107. Amplitude Balance vs. RF Frequency at Various Temperatures, RFIN = -20 dBm, LO = 2 dBm, IF = 2000 MHz, VDLNA = 3 V



PHASE BALANCE PERFORMANCE WITH UPPER SIDEBAND SELECTED

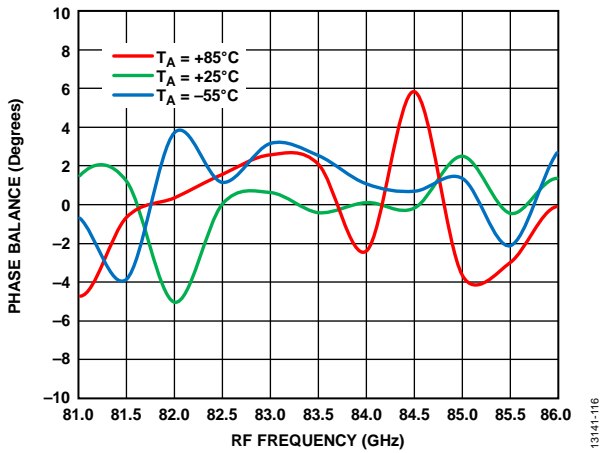

Figure 108. Phase Balance vs. RF Frequency at Various Temperatures, RFIN = -20 dBm, LO = 2 dBm, IF = 500 MHz, VDLNA = 4 V

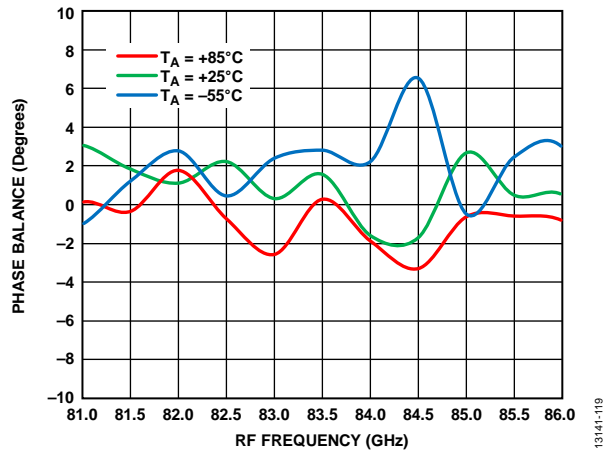

Figure 111. Phase Balance vs. RF Frequency at Various Temperatures, RFIN = -20 dBm, LO = 2 dBm, IF = 500 MHz, VDLNA = 3 V

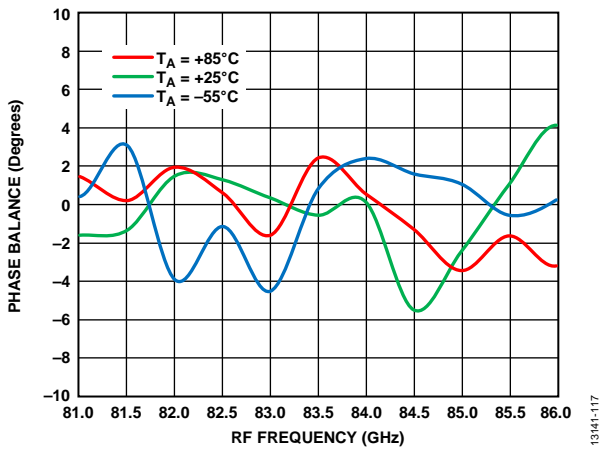

Figure 109. Phase Balance vs. RF Frequency at Various Temperatures, RFIN = -20 dBm, LO = 2 dBm, IF = 1000 MHz, VDLNA = 4 V

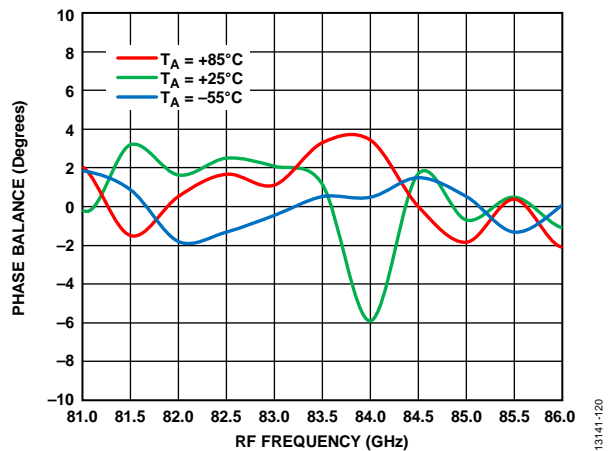

Figure 112. Phase Balance vs. RF Frequency at Various Temperatures, RFIN = -20 dBm, LO = 2 dBm, IF = 1000 MHz, VDLNA = 3 V

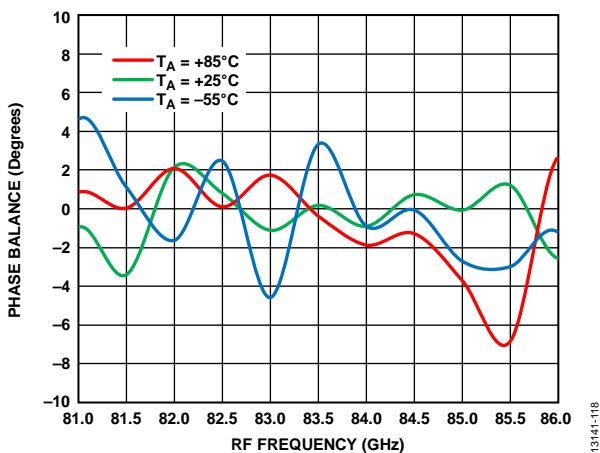

Figure 110. Phase Balance vs. RF Frequency at Various Temperatures, RFIN = -20 dBm, LO = 2 dBm, IF = 2000 MHz, VDLNA = 4 V

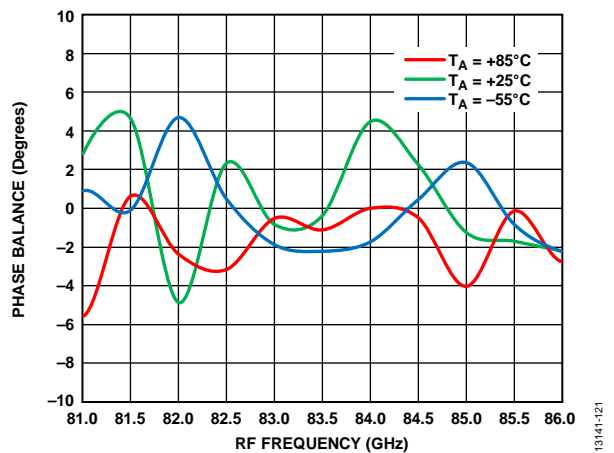

Figure 113. Phase Balance vs. RF Frequency at Various Temperatures, RFIN = -20 dBm, LO = 2 dBm, IF = 2000 MHz, VDLNA = 3 V

LOWER SIDEBAND SELECTED, IF = 500 MHz

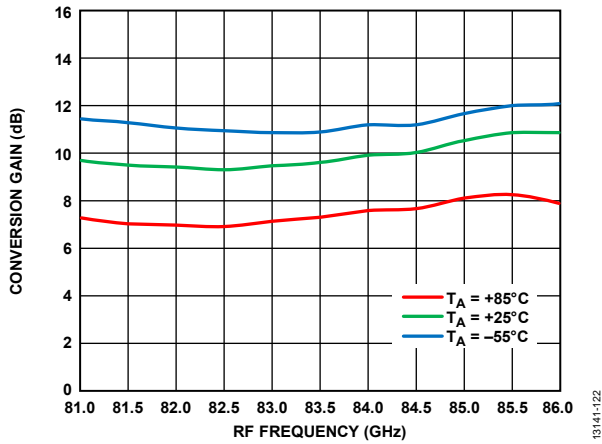

Figure 114. Conversion Gain vs. RF Frequency at Various Temperatures,  $R_{FIN} = -20$  dBm, LO = 2 dBm, IF = 500 MHz,  $V_{DLNA} = 4$  V

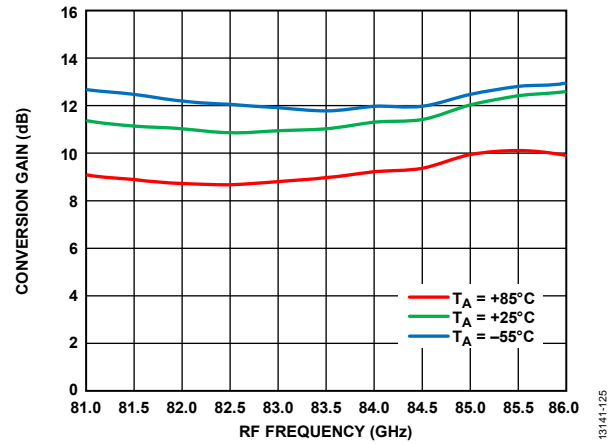

Figure 117. Conversion Gain vs. RF Frequency at Various Temperatures,  $R_{FIN} = -20$  dBm, LO = 2 dBm, IF = 500 MHz,  $V_{DLNA} = 3$  V

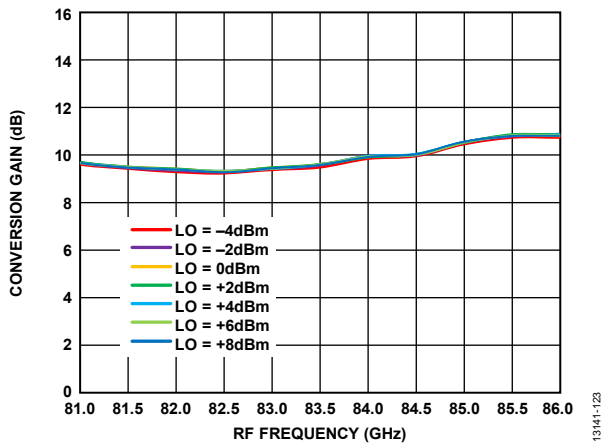

Figure 115. Conversion Gain vs. RF Frequency at Various LO Powers,  $R_{FIN} = -20$  dBm, IF = 500 MHz,  $V_{DLNA} = 4$  V

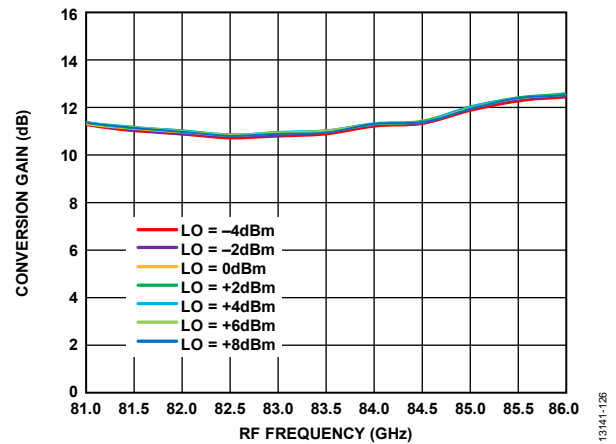

Figure 118. Conversion Gain vs. RF Frequency at Various LO Powers,  $R_{FIN} = -20$  dBm, IF = 500 MHz,  $V_{DLNA} = 3$  V

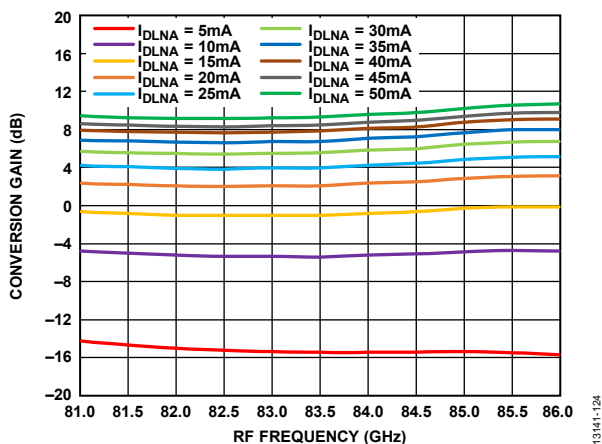

Figure 116. Conversion Gain vs. RF Frequency at Various  $I_{DLNA}$  Values,  $R_{FIN} = -20$  dBm, LO = 2 dBm, IF = 500 MHz,  $V_{DLNA} = 4$  V

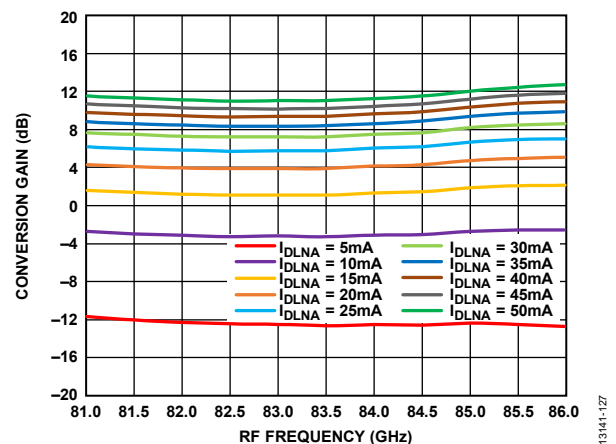

Figure 119. Conversion Gain vs. RF Frequency at Various  $I_{DLNA}$  Values,  $R_{FIN} = -20$  dBm, LO = 2 dBm, IF = 500 MHz,  $V_{DLNA} = 3$  V

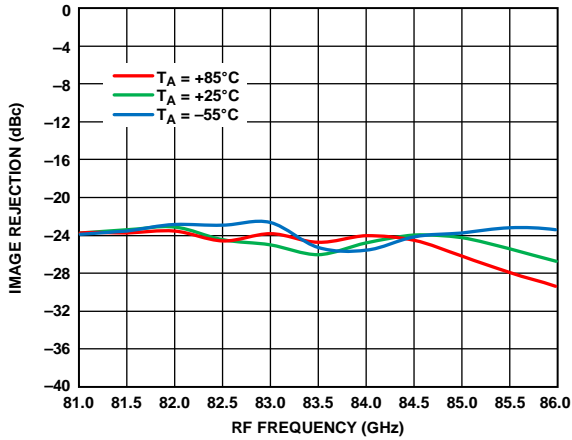

Figure 120. Image Rejection vs. RF Frequency at Various Temperatures,  $RFIN = -20\text{ dBm}$ ,  $LO = 2\text{ dBm}$ ,  $IF = 500\text{ MHz}$ ,  $V_{DLNA} = 4\text{ V}$

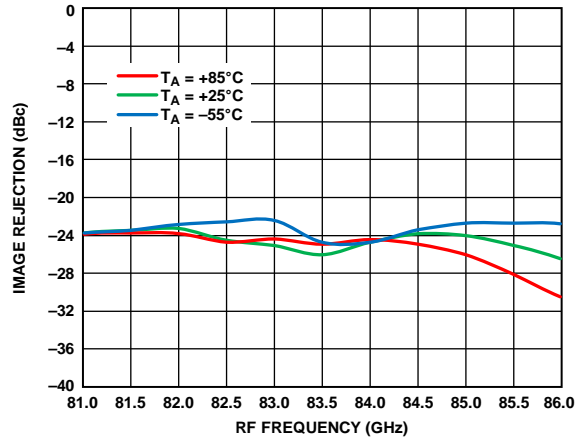

Figure 123. Image Rejection vs. RF Frequency at Various Temperatures,  $RFIN = -20\text{ dBm}$ ,  $LO = 2\text{ dBm}$ ,  $IF = 500\text{ MHz}$ ,  $V_{DLNA} = 3\text{ V}$

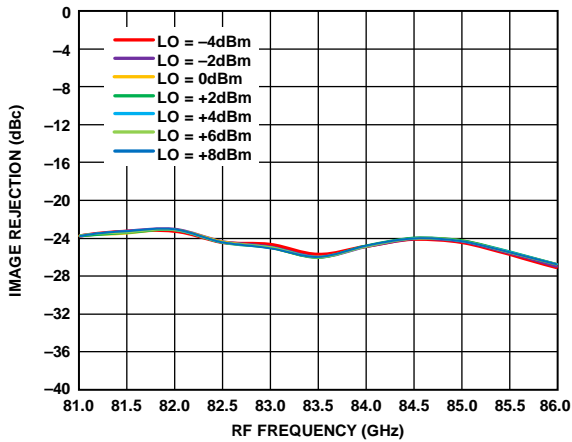

Figure 121. Image Rejection vs. RF Frequency at Various LO Powers,  $RFIN = -20\text{ dBm}$ ,  $IF = 500\text{ MHz}$ ,  $V_{DLNA} = 4\text{ V}$

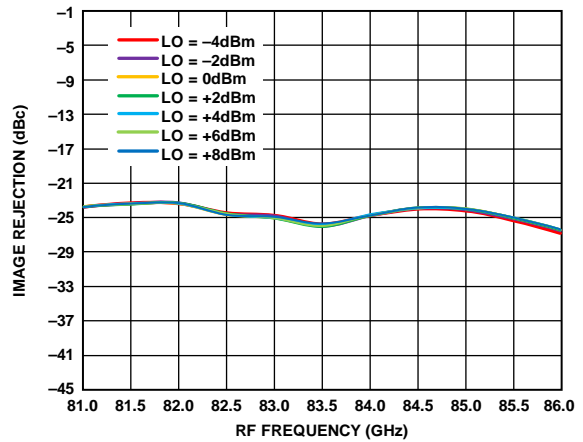

Figure 124. Image Rejection vs. RF Frequency at Various LO Powers,  $RFIN = -20\text{ dBm}$ ,  $IF = 500\text{ MHz}$ ,  $V_{DLNA} = 3\text{ V}$

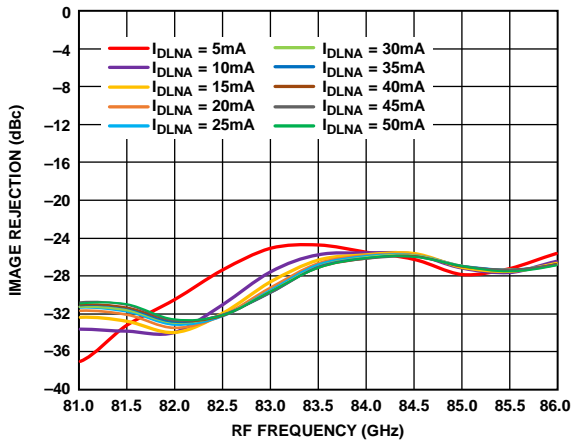

Figure 122. Image Rejection vs. RF Frequency at Various  $I_{DLNA}$  Values,  $RFIN = -20\text{ dBm}$ ,  $LO = 2\text{ dBm}$ ,  $IF = 500\text{ MHz}$ ,  $V_{DLNA} = 4\text{ V}$

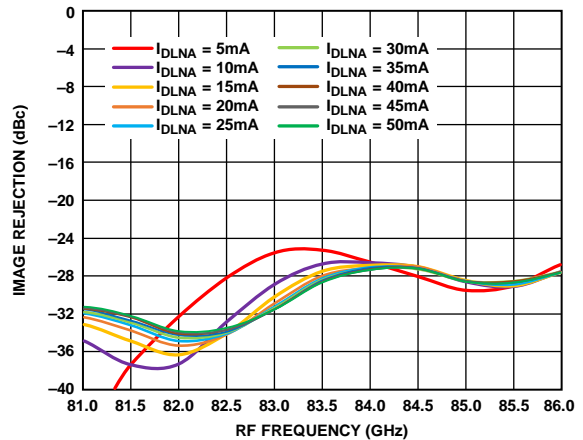
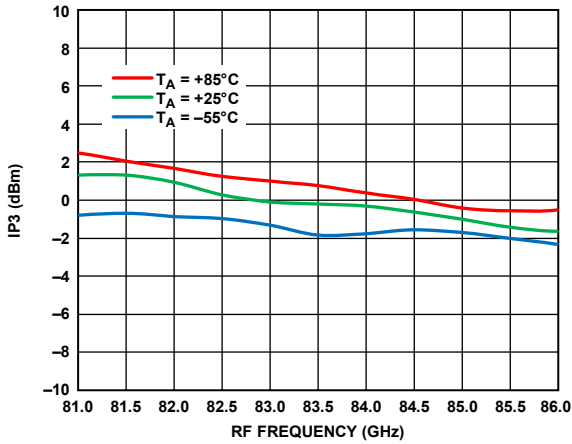
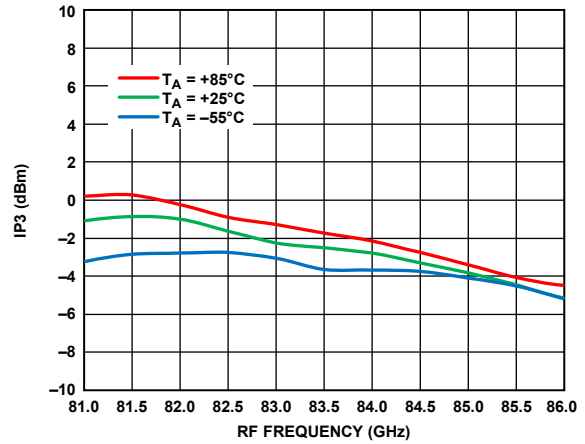

Figure 125. Image Rejection vs. RF Frequency at Various  $I_{DLNA}$  Values,  $RFIN = -20\text{ dBm}$ ,  $LO = 2\text{ dBm}$ ,  $IF = 500\text{ MHz}$ ,  $V_{DLNA} = 3\text{ V}$



131441-134

Figure 126. Input IP3 vs. RF Frequency at Various Temperatures,  $R_{FIN} = -20$  dBm,  $LO = 2$  dBm,  $IF = 500$  MHz,  $V_{DLNA} = 4$  V



131441-137

Figure 129. Input IP3 vs. RF Frequency at Various Temperatures,  $R_{FIN} = -20$  dBm,  $LO = 2$  dBm,  $IF = 500$  MHz,  $V_{DLNA} = 3$  V

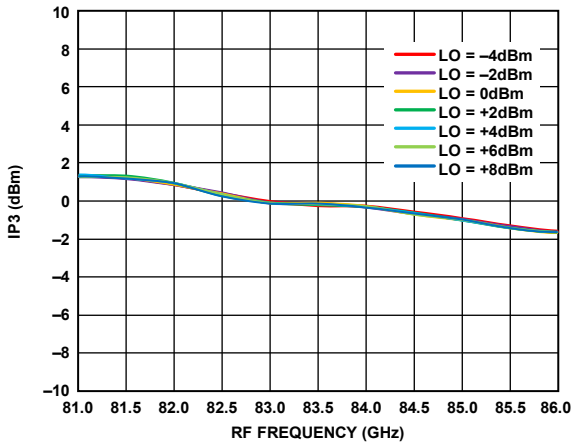

131441-135

Figure 127. Input IP3 vs. RF Frequency at Various LO Powers,  $R_{FIN} = -20$  dBm,  $IF = 500$  MHz,  $V_{DLNA} = 4$  V

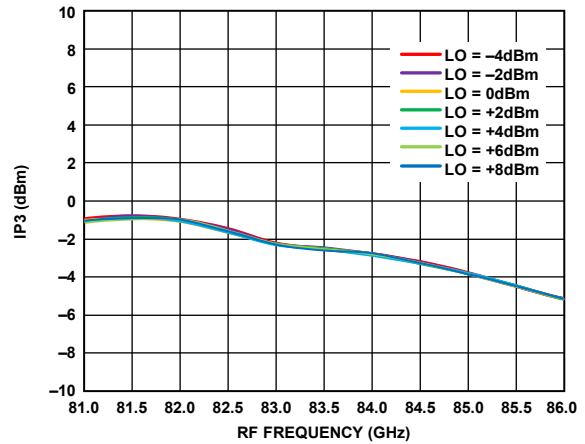

131441-138

Figure 130. Input IP3 vs. RF Frequency at Various LO Powers,  $R_{FIN} = -20$  dBm,  $IF = 500$  MHz,  $V_{DLNA} = 3$  V

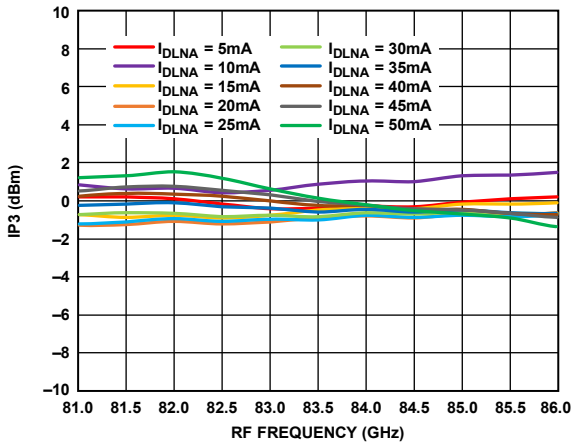

131441-136

Figure 128. Input IP3 vs. RF Frequency at Various  $I_{DLNA}$  Values,  $R_{FIN} = -20$  dBm,  $LO = 2$  dBm,  $IF = 500$  MHz,  $V_{DLNA} = 4$  V

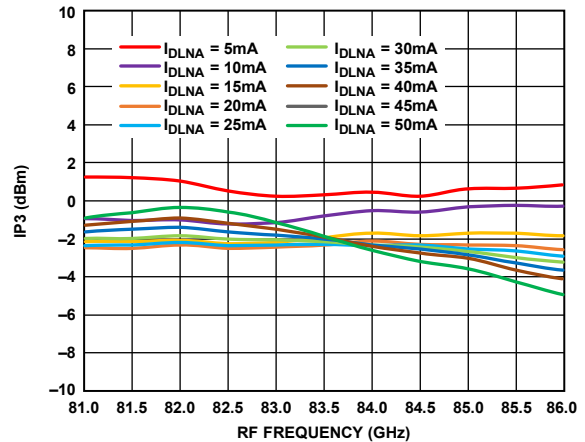

131441-139

Figure 131. Input IP3 vs. RF Frequency at Various  $I_{DLNA}$  Values,  $R_{FIN} = -20$  dBm,  $LO = 2$  dBm,  $IF = 500$  MHz,  $V_{DLNA} = 3$  V

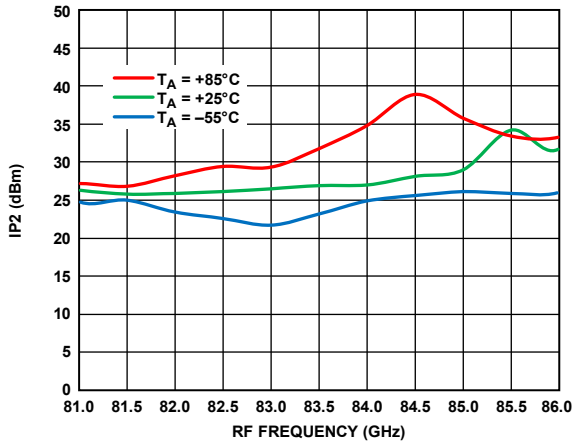

Figure 132. Input IP2 vs. RF Frequency at Various Temperatures,  $R_{FIN} = -20$  dBm,  $LO = 2$  dBm,  $IF = 500$  MHz,  $V_{DLNA} = 4$  V

13141-140

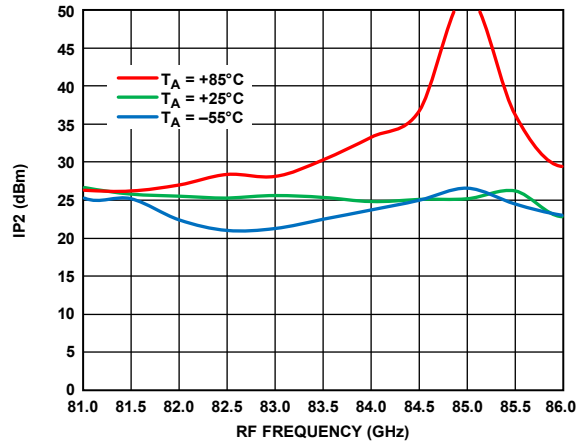

Figure 135. Input IP2 vs. RF Frequency at Various Temperatures,  $R_{FIN} = -20$  dBm,  $LO = 2$  dBm,  $IF = 500$  MHz,  $V_{DLNA} = 3$  V

13141-143

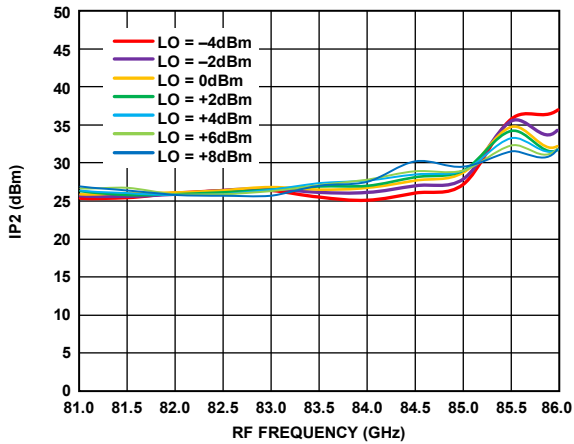

Figure 133. Input IP2 vs. RF Frequency at Various LO Powers,  $R_{FIN} = -20$  dBm,  $IF = 500$  MHz,  $V_{DLNA} = 4$  V

13141-141

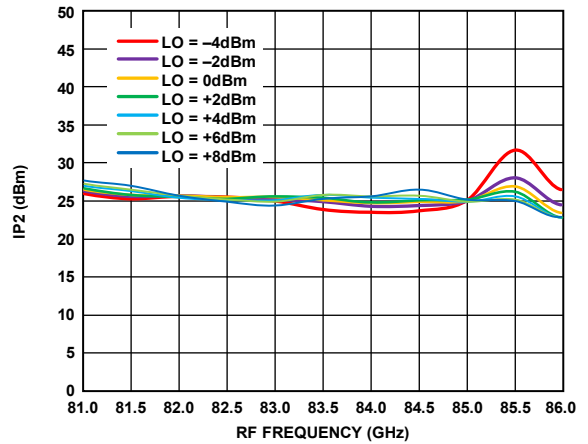

Figure 136. Input IP2 vs. RF Frequency at Various LO Powers,  $R_{FIN} = -20$  dBm,  $IF = 500$  MHz,  $V_{DLNA} = 3$  V

13141-144

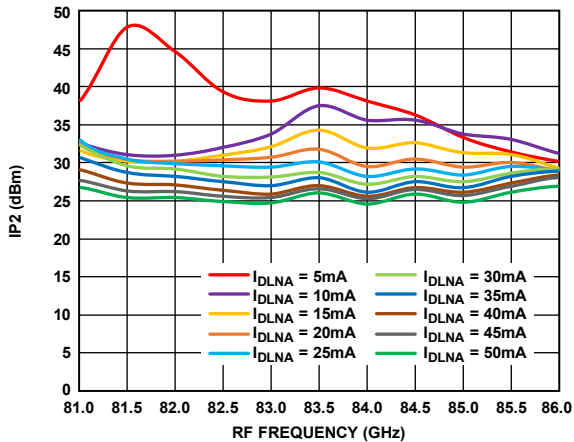

Figure 134. Input IP2 vs. RF Frequency at Various  $I_{DLNA}$  Values,  $R_{FIN} = -20$  dBm,  $LO = 2$  dBm,  $IF = 500$  MHz,  $V_{DLNA} = 4$  V

13141-142

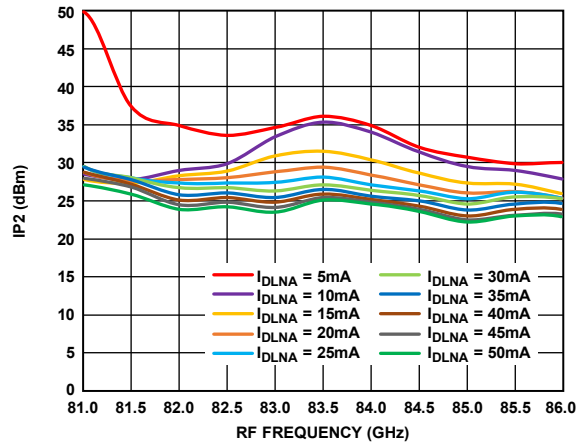

Figure 137. Input IP2 vs. RF Frequency at Various  $I_{DLNA}$  Values,  $R_{FIN} = -20$  dBm,  $LO = 2$  dBm,  $IF = 500$  MHz,  $V_{DLNA} = 3$  V

13141-145

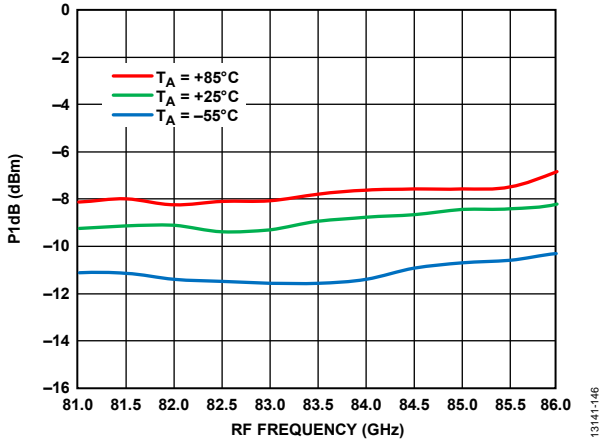

Figure 138. Input P1dB vs. RF Frequency at Various Temperatures, LO = 2 dBm, IF = 500 MHz, V<sub>DLNA</sub> = 4 V

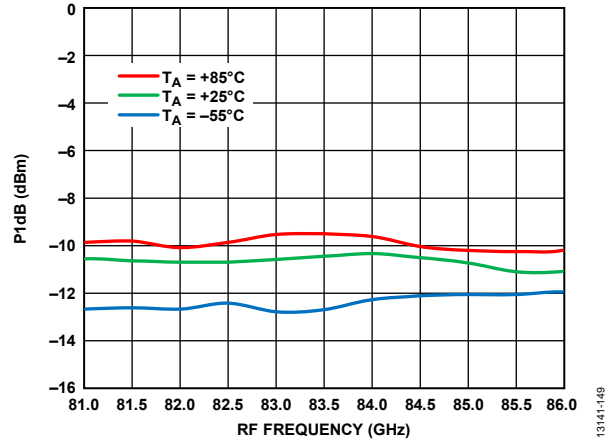

Figure 139. Input P1dB vs. RF Frequency at Various Temperatures, LO = 2 dBm, IF = 500 MHz, V<sub>DLNA</sub> = 3 V

13141-146

13141-146

LOWER SIDEBAND SELECTED, IF = 1000 MHz

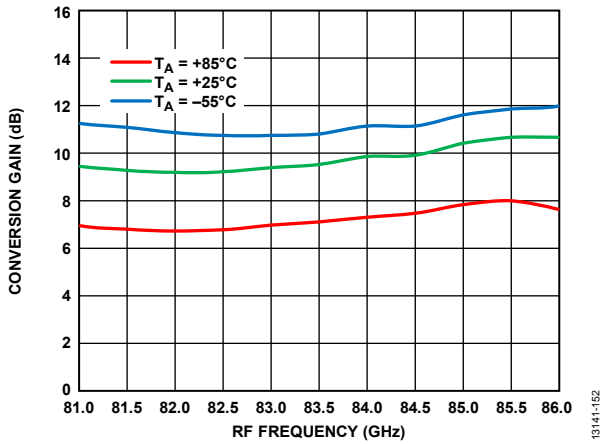

Figure 140. Conversion Gain vs. RF Frequency at Various Temperatures,  $R_{FIN} = -20$  dBm,  $LO = 2$  dBm,  $IF = 1000$  MHz,  $V_{DLNA} = 4$  V

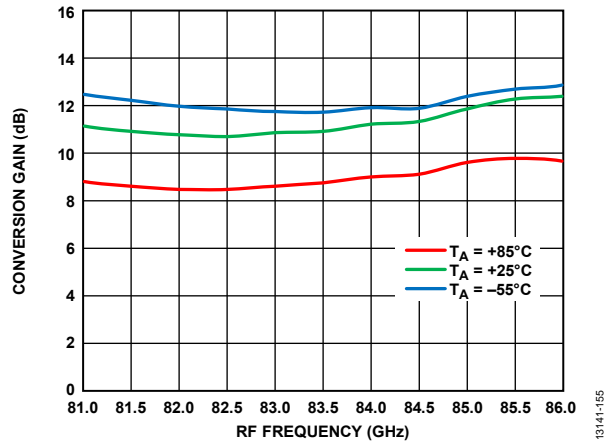

Figure 143. Conversion Gain vs. RF Frequency at Various Temperatures,  $R_{FIN} = -20$  dBm,  $LO = 2$  dBm,  $IF = 1000$  MHz,  $V_{DLNA} = 3$  V

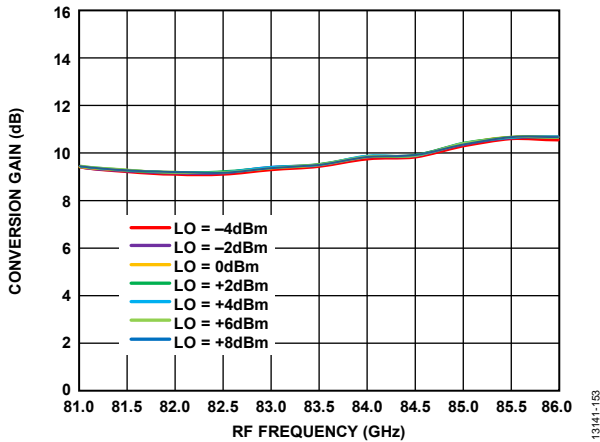

Figure 141. Conversion Gain vs. RF Frequency at Various LO Powers,  $R_{FIN} = -20$  dBm,  $IF = 1000$  MHz,  $V_{DLNA} = 4$  V

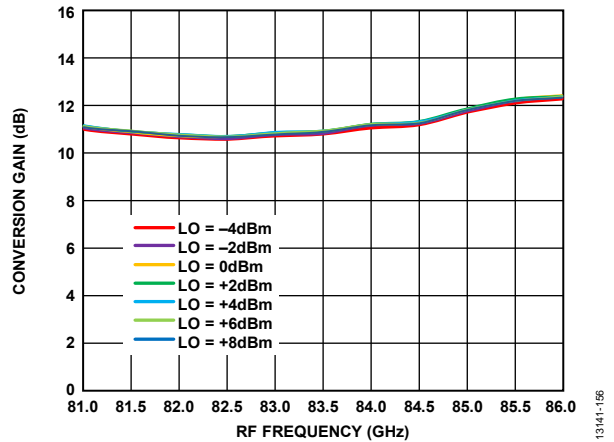

Figure 144. Conversion Gain vs. RF Frequency at Various LO Powers,  $R_{FIN} = -20$  dBm,  $IF = 1000$  MHz,  $V_{DLNA} = 3$  V

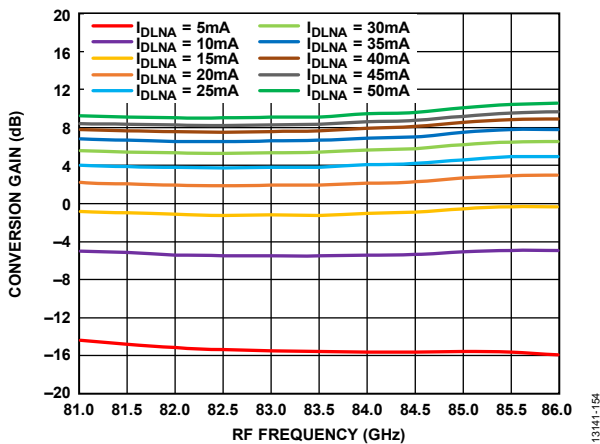

Figure 142. Conversion Gain vs. RF Frequency at Various  $I_{DLNA}$  Values,  $R_{FIN} = -20$  dBm,  $LO = 2$  dBm,  $IF = 1000$  MHz,  $V_{DLNA} = 4$  V

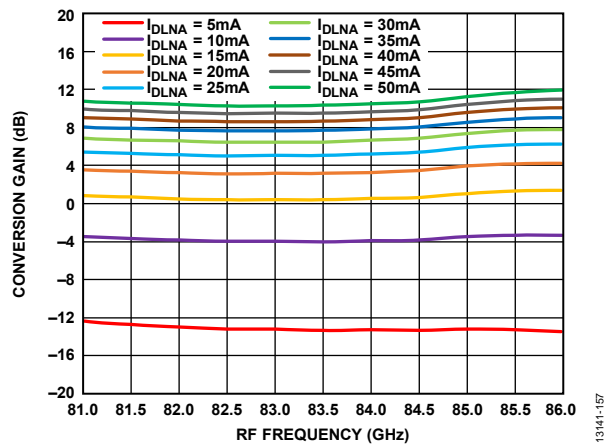

Figure 145. Conversion Gain vs. RF Frequency at Various  $I_{DLNA}$  Values,  $R_{FIN} = -20$  dBm,  $LO = 2$  dBm,  $IF = 1000$  MHz,  $V_{DLNA} = 3$  V

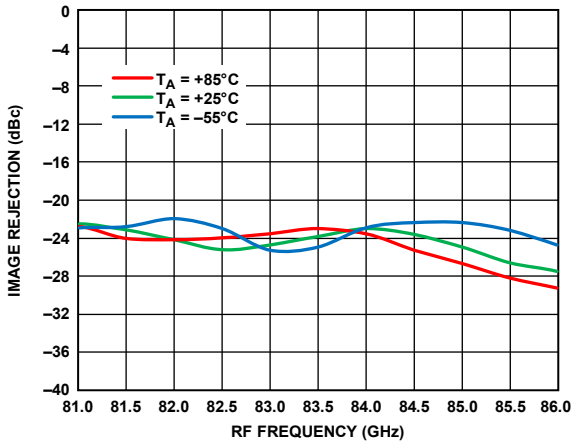

Figure 146. Image Rejection vs. RF Frequency at Various Temperatures,  $R_{FIN} = -20$  dBm,  $LO = 2$  dBm,  $IF = 1000$  MHz,  $V_{DLNA} = 4$  V

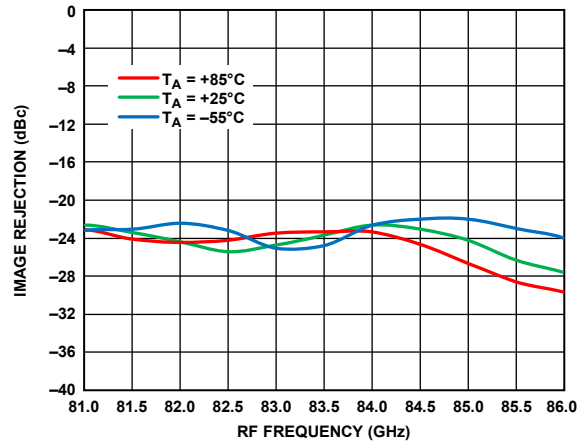

Figure 149. Image Rejection vs. RF Frequency at Various Temperatures,  $R_{FIN} = -20$  dBm,  $LO = 2$  dBm,  $IF = 1000$  MHz,  $V_{DLNA} = 3$  V

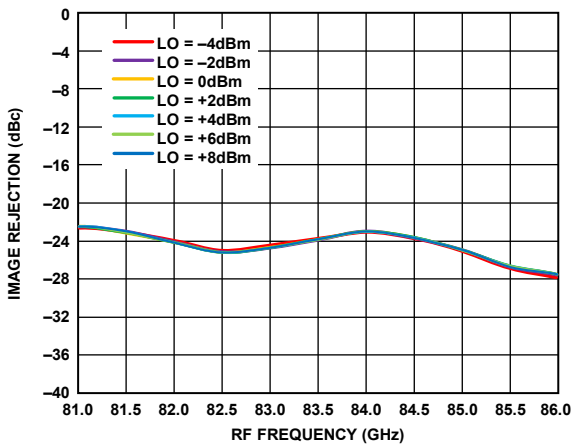

Figure 147. Image Rejection vs. RF Frequency at Various LO Powers,  $R_{FIN} = -20$  dBm,  $IF = 1000$  MHz,  $V_{DLNA} = 4$  V

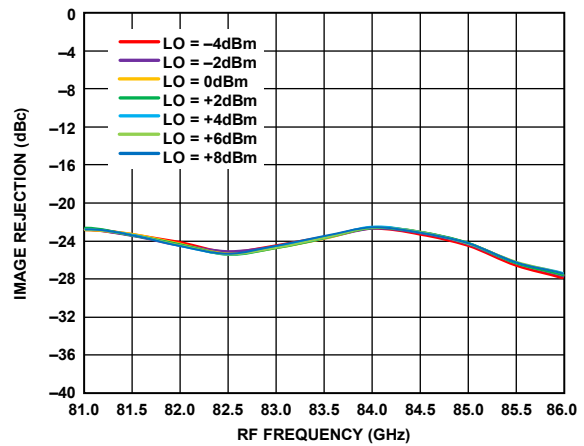

Figure 150. Image Rejection vs. RF Frequency at Various LO Powers,  $R_{FIN} = -20$  dBm,  $IF = 1000$  MHz,  $V_{DLNA} = 3$  V

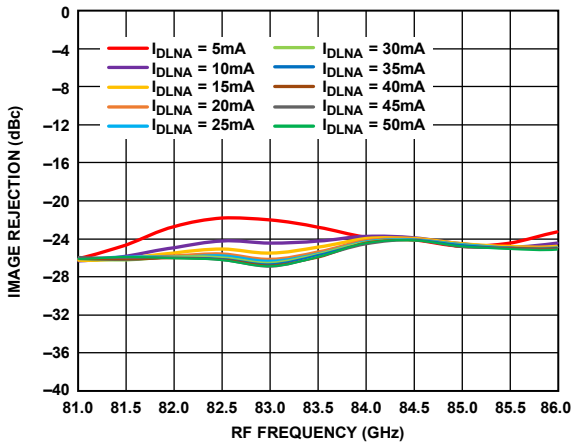

Figure 148. Image Rejection vs. RF Frequency at Various  $I_{DLNA}$  Values,  $R_{FIN} = -20$  dBm,  $LO = 2$  dBm,  $IF = 1000$  MHz,  $V_{DLNA} = 4$  V

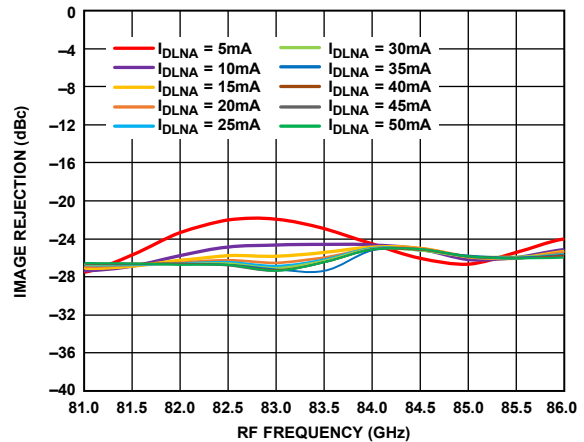

Figure 151. Image Rejection vs. RF Frequency at Various  $I_{DLNA}$  Values,  $R_{FIN} = -20$  dBm,  $LO = 2$  dBm,  $IF = 1000$  MHz,  $V_{DLNA} = 3$  V



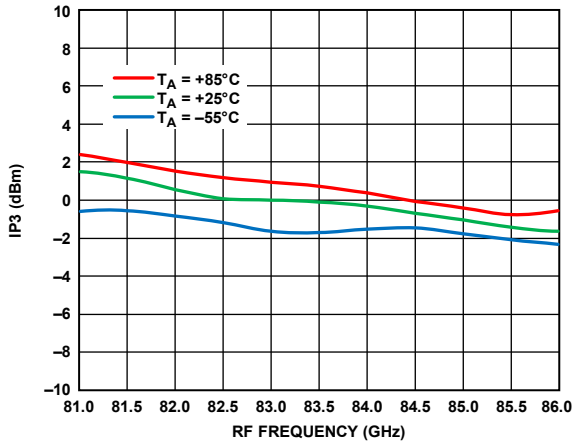

Figure 152. Input IP3 vs. RF Frequency at Various Temperatures,  $R_{FIN} = -20$  dBm,  $LO = 2$  dBm,  $IF = 1000$  MHz,  $V_{DLNA} = 4$  V

13141-164

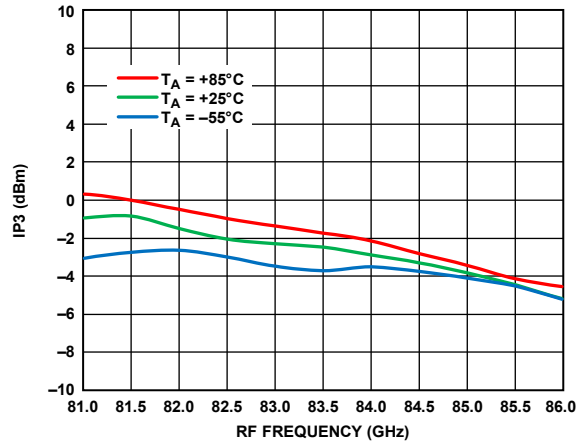

Figure 155. Input IP3 vs. RF Frequency at Various Temperatures,  $R_{FIN} = -20$  dBm,  $LO = 2$  dBm,  $IF = 1000$  MHz,  $V_{DLNA} = 3$  V

13141-167

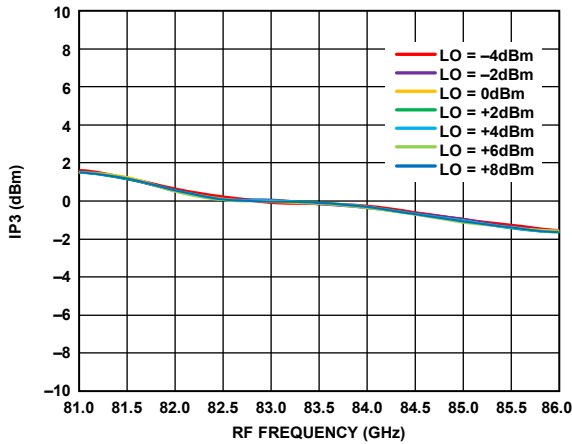

Figure 153. Input IP3 vs. RF Frequency at Various LO Powers,  $R_{FIN} = -20$  dBm,  $IF = 1000$  MHz,  $V_{DLNA} = 4$  V

13141-165

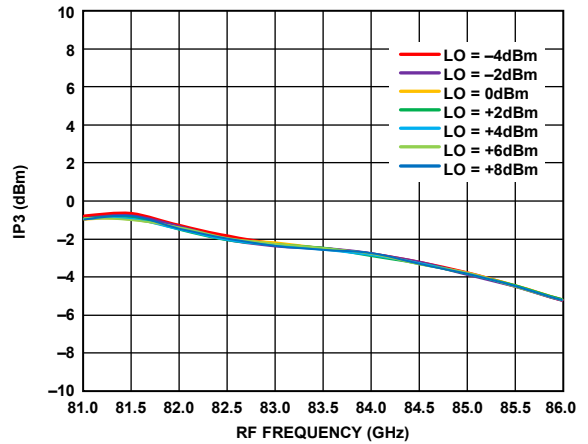

Figure 156. Input IP3 vs. RF Frequency at Various LO Powers,  $R_{FIN} = -20$  dBm,  $IF = 1000$  MHz,  $V_{DLNA} = 3$  V

13141-168

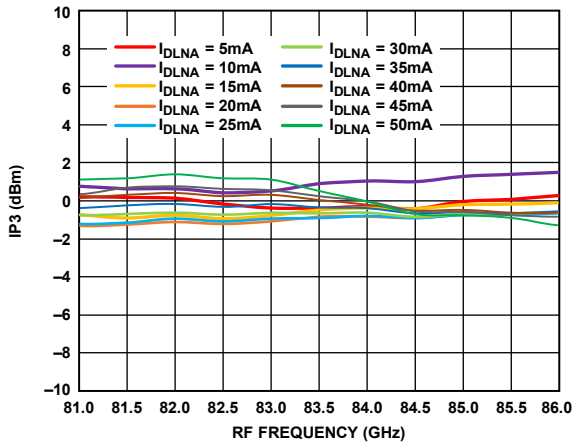

Figure 154. Input IP3 vs. RF Frequency at Various  $I_{DLNA}$  Values,  $R_{FIN} = -20$  dBm,  $LO = 2$  dBm,  $IF = 1000$  MHz,  $V_{DLNA} = 4$  V

13141-166

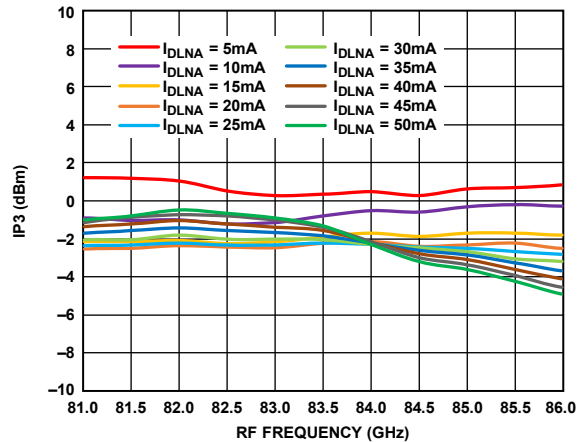
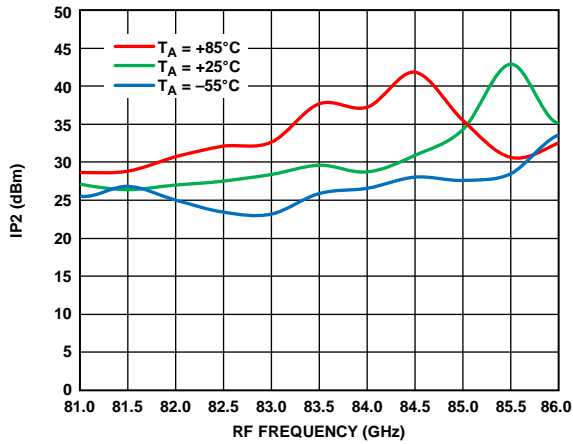

Figure 157. Input IP3 vs. RF Frequency at Various  $I_{DLNA}$  Values,  $R_{FIN} = -20$  dBm,  $LO = 2$  dBm,  $IF = 1000$  MHz,  $V_{DLNA} = 3$  V

13141-169



13141-170

Figure 158. Input IP2 vs. RF Frequency at Various Temperatures,  $R_{FIN} = -20$  dBm,  $LO = 2$  dBm,  $IF = 1000$  MHz,  $V_{DLNA} = 4$  V

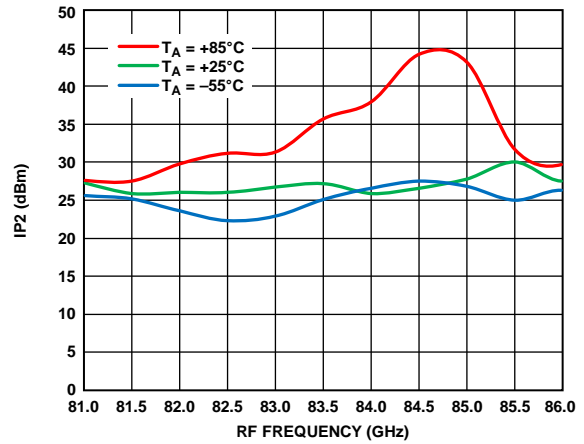

13141-173

Figure 161. Input IP2 vs. RF Frequency at Various Temperatures,  $R_{FIN} = -20$  dBm,  $LO = 2$  dBm,  $IF = 1000$  MHz,  $V_{DLNA} = 3$  V

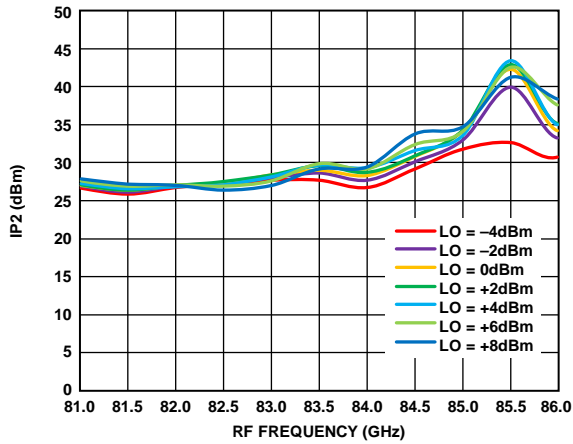

13141-171

Figure 159. Input IP2 vs. RF Frequency at Various LO Powers,  $R_{FIN} = -20$  dBm,  $IF = 1000$  MHz,  $V_{DLNA} = 4$  V

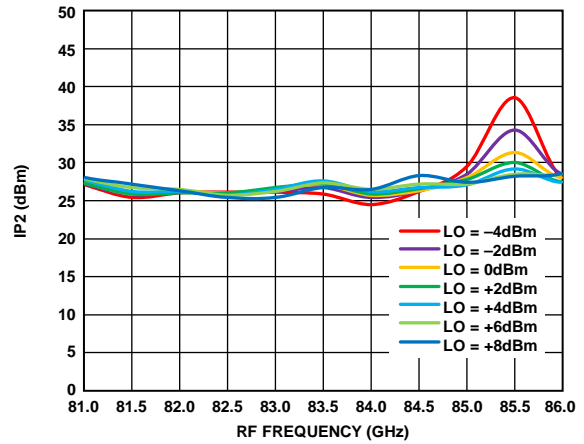

13141-174

Figure 162. Input IP2 vs. RF Frequency at Various LO Powers,  $R_{FIN} = -20$  dBm,  $IF = 1000$  MHz,  $V_{DLNA} = 3$  V

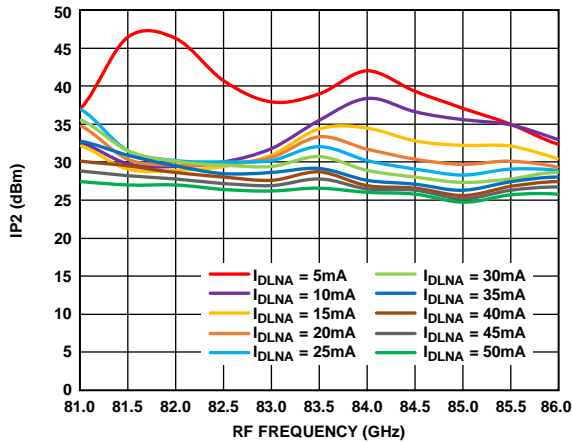

13141-172

Figure 160. Input IP2 vs. RF Frequency at Various  $I_{DLNA}$  Values,  $R_{FIN} = -20$  dBm,  $LO = 2$  dBm,  $IF = 1000$  MHz,  $V_{DLNA} = 4$  V

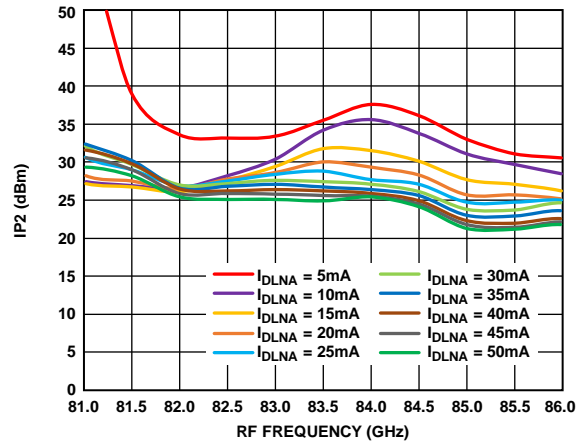

13141-175

Figure 163. Input IP2 vs. RF Frequency at Various  $I_{DLNA}$  Values,  $R_{FIN} = -20$  dBm,  $LO = 2$  dBm,  $IF = 1000$  MHz,  $V_{DLNA} = 3$  V

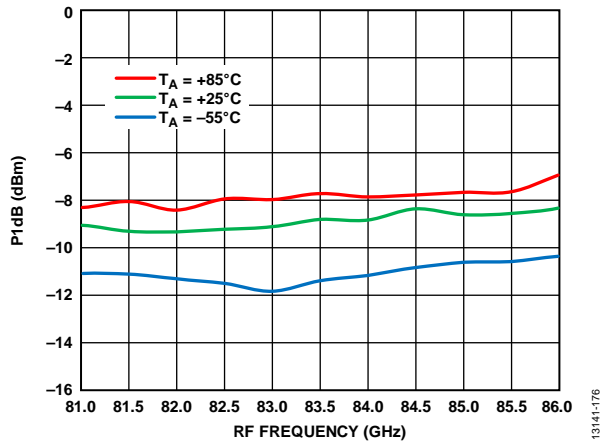

Figure 164. Input P1dB vs. RF Frequency at Various Temperatures, LO = 2 dBm, IF = 1000 MHz,  $V_{DLNA} = 4\text{ V}$

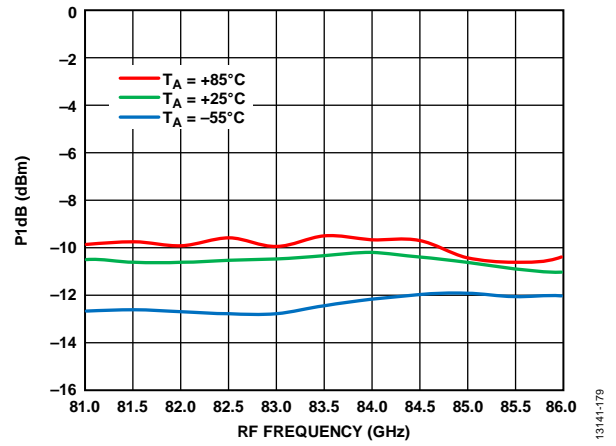

Figure 165. Input P1dB vs. RF Frequency at Various Temperatures, LO = 2 dBm, IF = 1000 MHz,  $V_{DLNA} = 3\text{ V}$

LOWER SIDEBAND SELECTED, IF = 2000 MHz

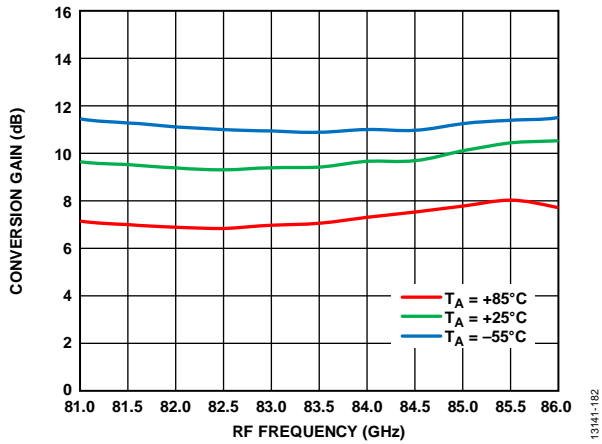

Figure 166. Conversion Gain vs. RF Frequency at Various Temperatures,  $RFIN = -20$  dBm,  $LO = 2$  dBm,  $IF = 2000$  MHz,  $V_{DLNA} = 4$  V

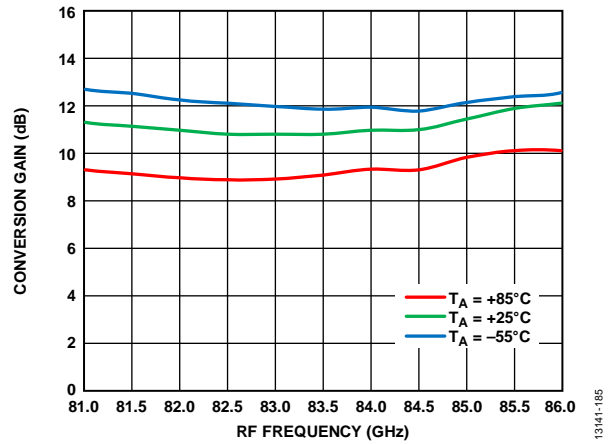

Figure 169. Conversion Gain vs. RF Frequency at Various Temperatures,  $RFIN = -20$  dBm,  $LO = 2$  dBm,  $IF = 2000$  MHz,  $V_{DLNA} = 3$  V

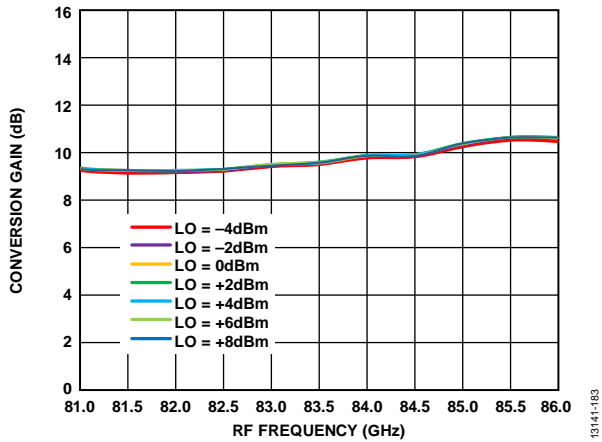

Figure 167. Conversion Gain vs. RF Frequency at Various LO Powers,  $RFIN = -20$  dBm,  $IF = 2000$  MHz,  $V_{DLNA} = 4$  V

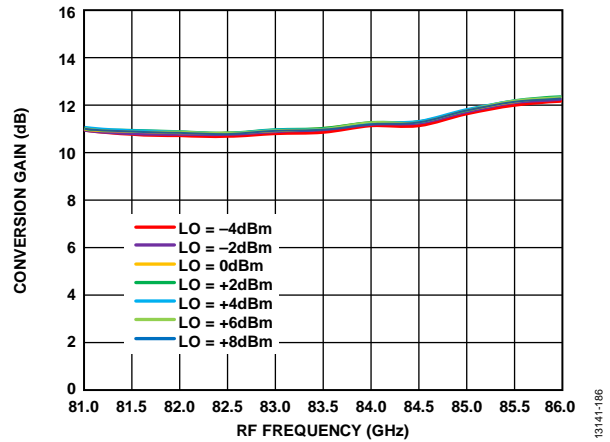

Figure 170. Conversion Gain vs. RF Frequency at Various LO Powers,  $RFIN = -20$  dBm,  $IF = 2000$  MHz,  $V_{DLNA} = 3$  V

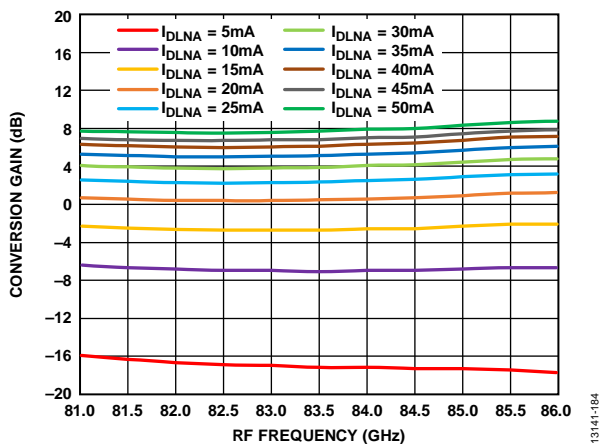

Figure 168. Conversion Gain vs. RF Frequency at Various  $IDLNA$  Values,  $RFIN = -20$  dBm,  $LO = 2$  dBm,  $IF = 2000$  MHz,  $V_{DLNA} = 4$  V

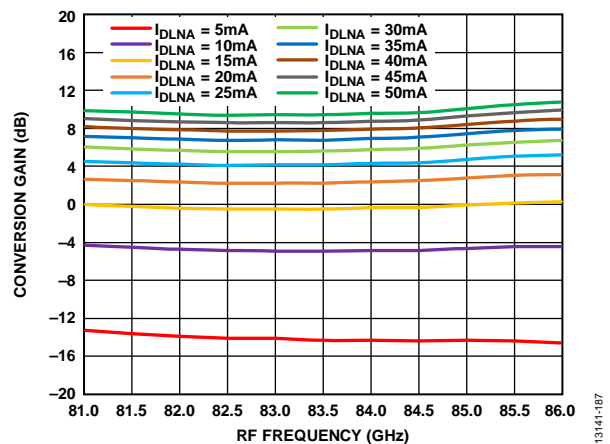

Figure 171. Conversion Gain vs. RF Frequency at Various  $IDLNA$  Values,  $RFIN = -20$  dBm,  $LO = 2$  dBm,  $IF = 2000$  MHz,  $V_{DLNA} = 3$  V

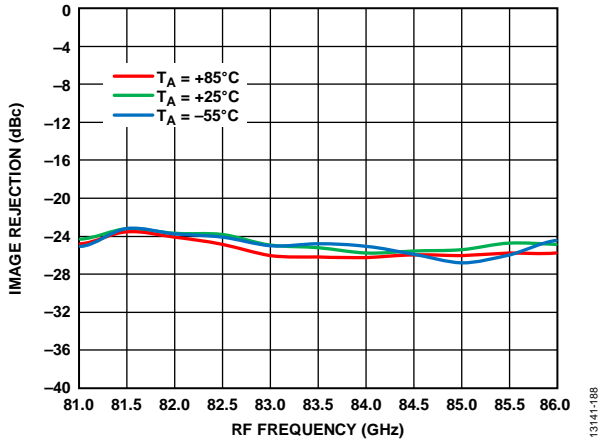

Figure 172. Image Rejection vs. RF Frequency at Various Temperatures,  $RFIN = -20\text{ dBm}$ ,  $LO = 2\text{ dBm}$ ,  $IF = 2000\text{ MHz}$ ,  $V_{DLNA} = 4\text{ V}$

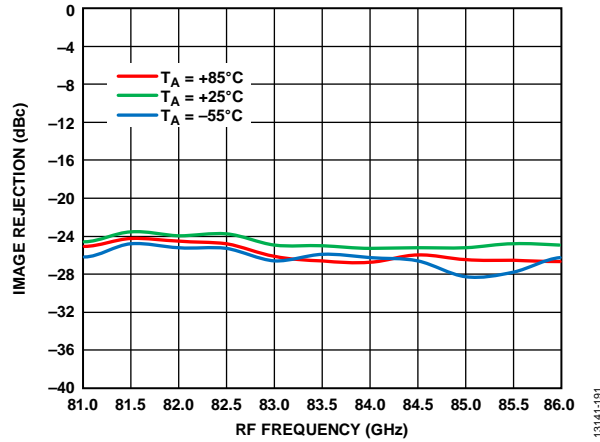

Figure 175. Image Rejection vs. RF Frequency at Various Temperatures,  $RFIN = -20\text{ dBm}$ ,  $LO = 2\text{ dBm}$ ,  $IF = 2000\text{ MHz}$ ,  $V_{DLNA} = 3\text{ V}$

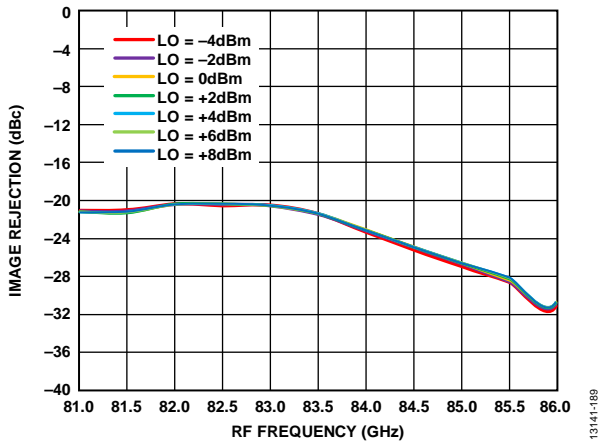

Figure 173. Image Rejection vs. RF Frequency at Various LO Powers,  $RFIN = -20\text{ dBm}$ ,  $IF = 2000\text{ MHz}$ ,  $V_{DLNA} = 4\text{ V}$

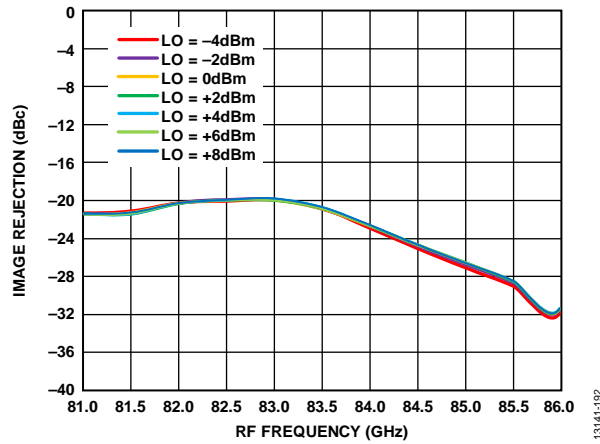

Figure 176. Image Rejection vs. RF Frequency at Various LO Powers,  $RFIN = -20\text{ dBm}$ ,  $IF = 2000\text{ MHz}$ ,  $V_{DLNA} = 3\text{ V}$

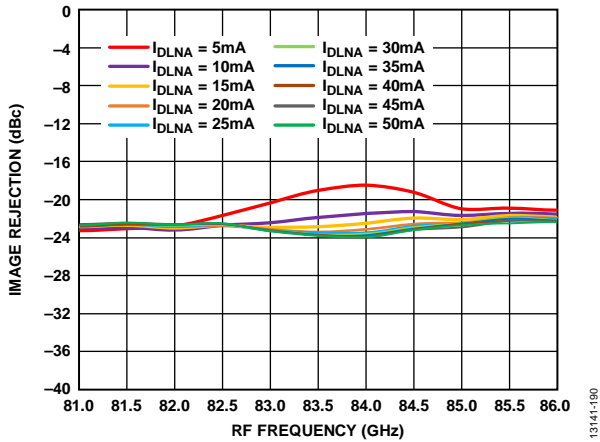

Figure 174. Image Rejection vs. RF Frequency at Various  $I_{DLNA}$  Values,  $RFIN = -20\text{ dBm}$ ,  $LO = 2\text{ dBm}$ ,  $IF = 2000\text{ MHz}$ ,  $V_{DLNA} = 4\text{ V}$

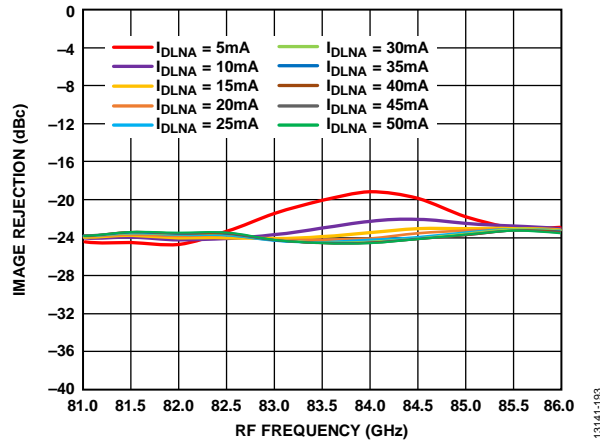
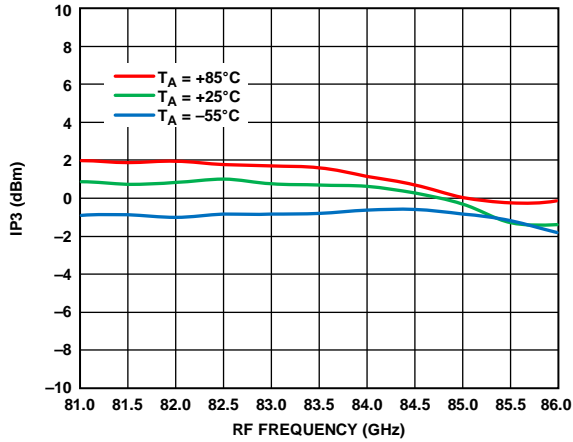
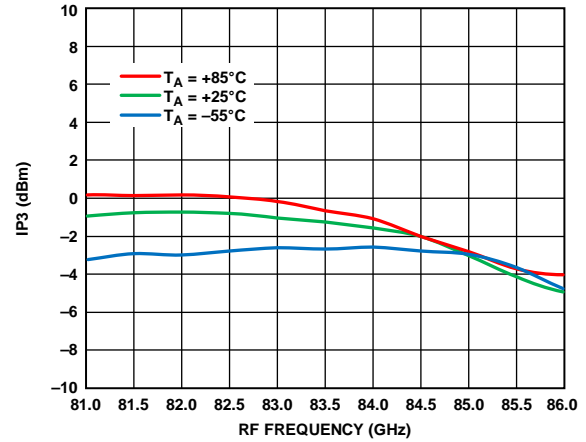

Figure 177. Image Rejection vs. RF Frequency at Various  $I_{DLNA}$  Values,  $RFIN = -20\text{ dBm}$ ,  $LO = 2\text{ dBm}$ ,  $IF = 2000\text{ MHz}$ ,  $V_{DLNA} = 3\text{ V}$



13141-194

Figure 178. Input IP3 vs. RF Frequency at Various Temperatures,  $R_{FIN} = -20$  dBm,  $LO = 2$  dBm,  $IF = 2000$  MHz,  $V_{DLNA} = 4$  V



13141-197

Figure 181. Input IP3 vs. RF Frequency at Various Temperatures,  $R_{FIN} = -20$  dBm,  $LO = 2$  dBm,  $IF = 2000$  MHz,  $V_{DLNA} = 3$  V

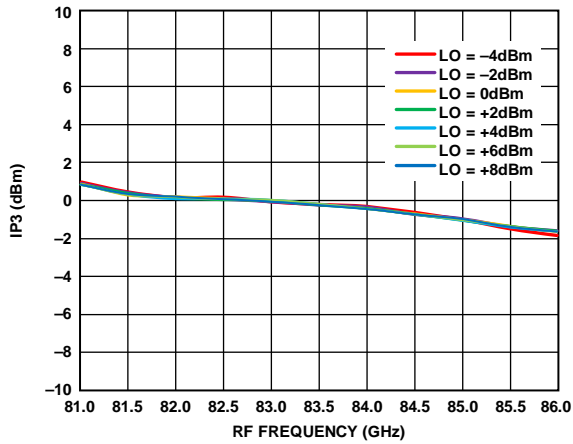

13141-195

Figure 179. Input IP3 vs. RF Frequency at Various LO Powers,  $R_{FIN} = -20$  dBm,  $IF = 2000$  MHz,  $V_{DLNA} = 4$  V

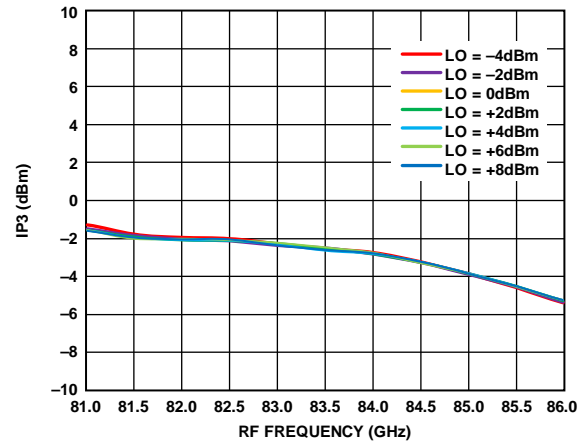

13141-198

Figure 182. Input IP3 vs. RF Frequency at Various LO Powers,  $R_{FIN} = -20$  dBm,  $IF = 2000$  MHz,  $V_{DLNA} = 3$  V

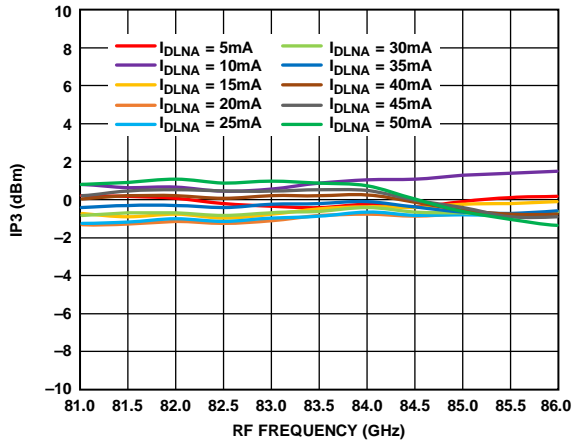

13141-196

Figure 180. Input IP3 vs. RF Frequency at Various  $I_{DLNA}$  Values,  $R_{FIN} = -20$  dBm,  $LO = 2$  dBm,  $IF = 2000$  MHz,  $V_{DLNA} = 4$  V

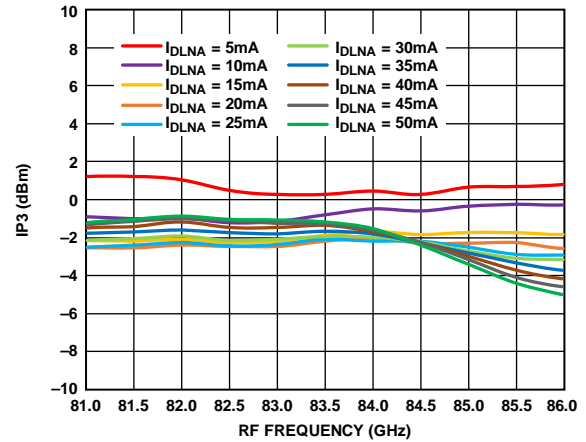

13141-199

Figure 183. Input IP3 vs. RF Frequency at Various  $I_{DLNA}$  Values,  $R_{FIN} = -20$  dBm,  $LO = 2$  dBm,  $IF = 2000$  MHz,  $V_{DLNA} = 3$  V

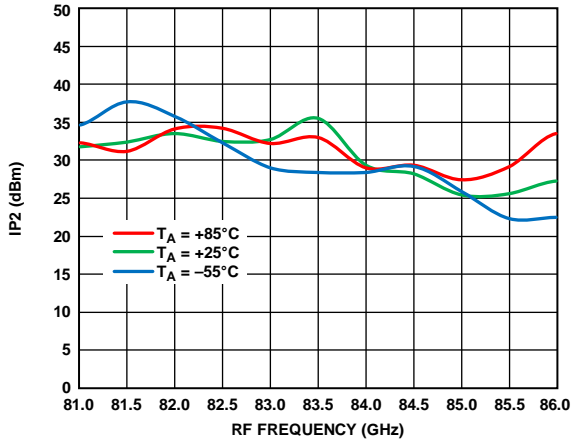

Figure 184. Input IP2 vs. RF Frequency at Various Temperatures,  $RFIN = -20\text{ dBm}$ ,  $LO = 2\text{ dBm}$ ,  $IF = 2000\text{ MHz}$ ,  $V_{DLNA} = 4\text{ V}$

13141-200

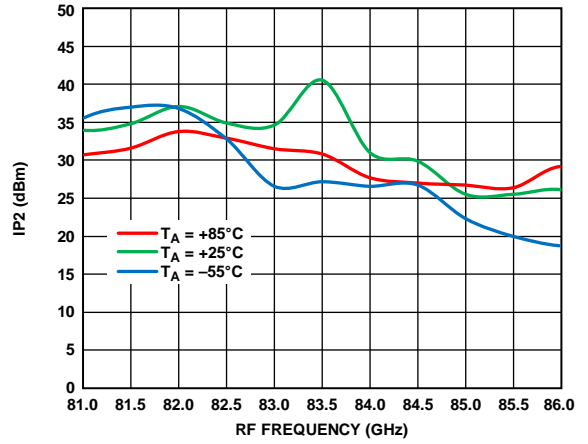

Figure 187. Input IP2 vs. RF Frequency at Various Temperatures,  $RFIN = -20\text{ dBm}$ ,  $LO = 2\text{ dBm}$ ,  $IF = 2000\text{ MHz}$ ,  $V_{DLNA} = 3\text{ V}$

13141-203

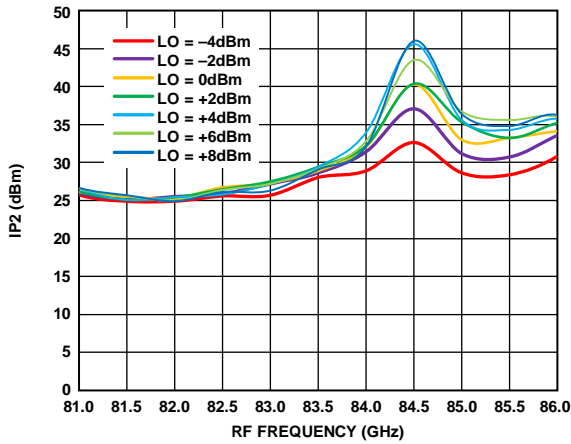

Figure 185. Input IP2 vs. RF Frequency at Various LO Powers,  $RFIN = -20\text{ dBm}$ ,  $IF = 2000\text{ MHz}$ ,  $V_{DLNA} = 4\text{ V}$

13141-201

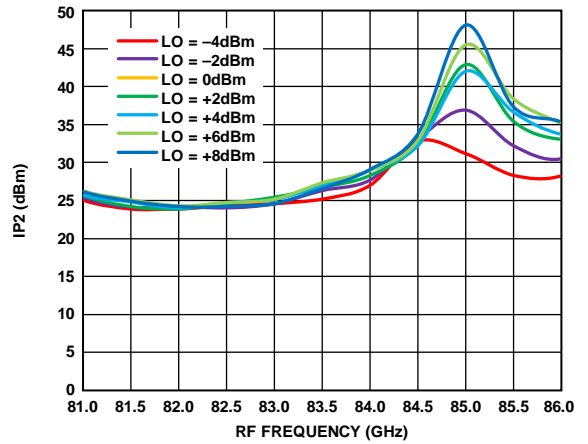

Figure 188. Input IP2 vs. RF Frequency at Various LO Powers,  $RFIN = -20\text{ dBm}$ ,  $IF = 2000\text{ MHz}$ ,  $V_{DLNA} = 3\text{ V}$

13141-204

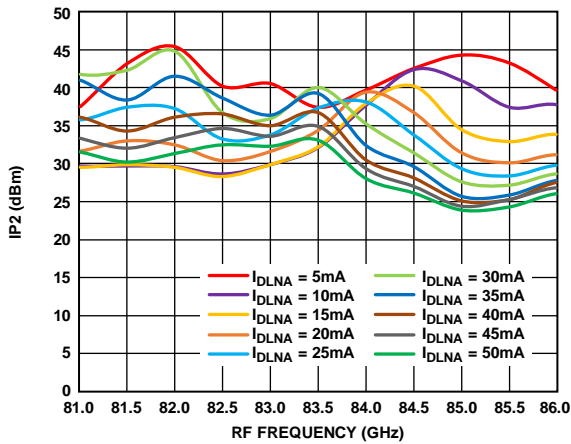

Figure 186. Input IP2 vs. RF Frequency at Various  $I_{DLNA}$  Values,  $RFIN = -20\text{ dBm}$ ,  $LO = 2\text{ dBm}$ ,  $IF = 2000\text{ MHz}$ ,  $V_{DLNA} = 4\text{ V}$

13141-202

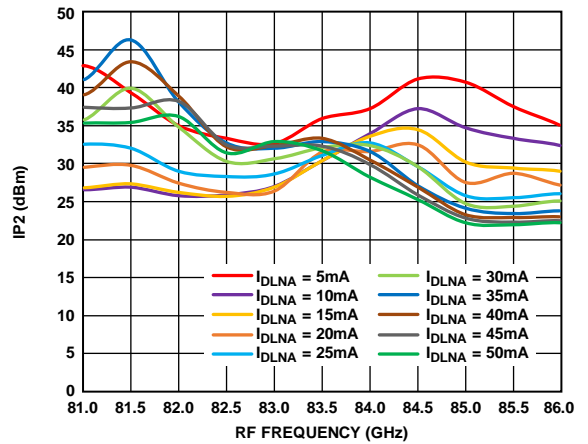

Figure 189. Input IP2 vs. RF Frequency at Various  $I_{DLNA}$  Values,  $RFIN = -20\text{ dBm}$ ,  $LO = 2\text{ dBm}$ ,  $IF = 2000\text{ MHz}$ ,  $V_{DLNA} = 3\text{ V}$

13141-205

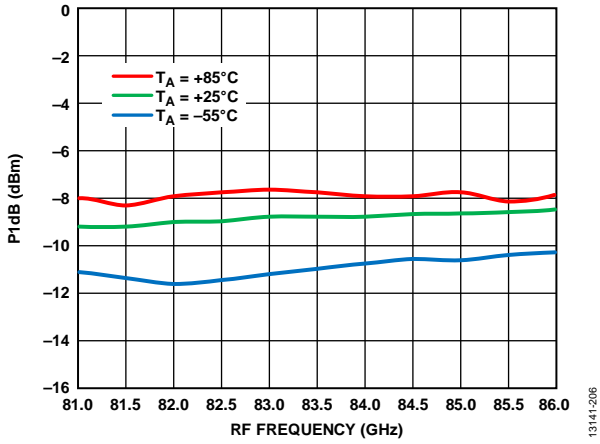

Figure 190. Input P1dB vs. RF Frequency at Various Temperatures, LO = 2 dBm, IF = 2000 MHz, V<sub>DLNA</sub> = 4 V

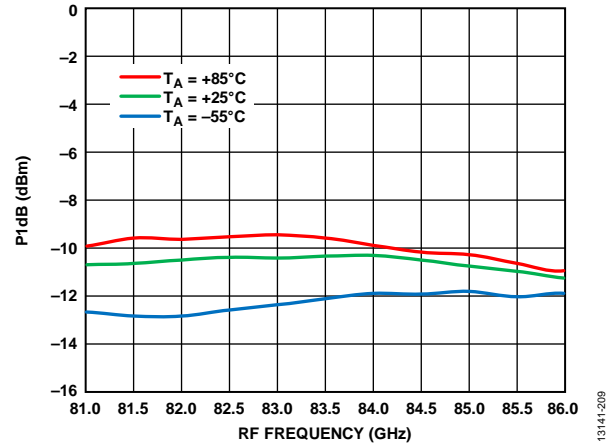

Figure 191. Input P1dB vs. RF Frequency at Various Temperatures, LO = 2 dBm, IF = 2000 MHz, V<sub>DLNA</sub> = 3 V



**NOISE FIGURE PERFORMANCE WITH LOWER SIDEBAND SELECTED**

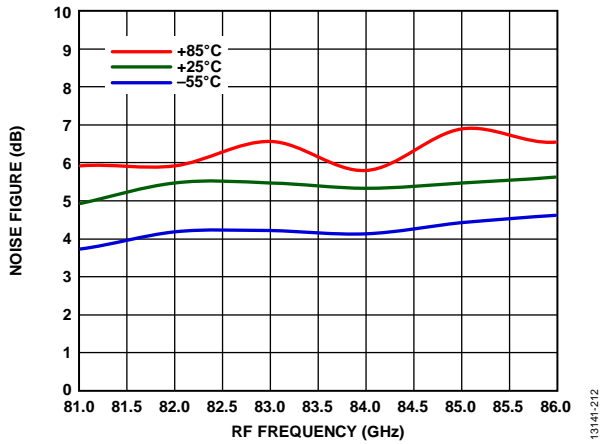

Figure 192. Noise Figure vs. RF Frequency at Various Temperatures, LO = 2 dBm, IF = 500 MHz, V<sub>DLNA</sub> = 3 V

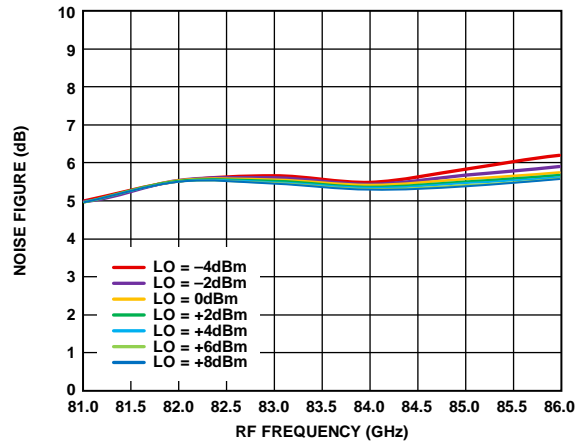

Figure 195. Noise Figure vs. RF Frequency at Various LO Powers, IF = 500 MHz, V<sub>DLNA</sub> = 3 V

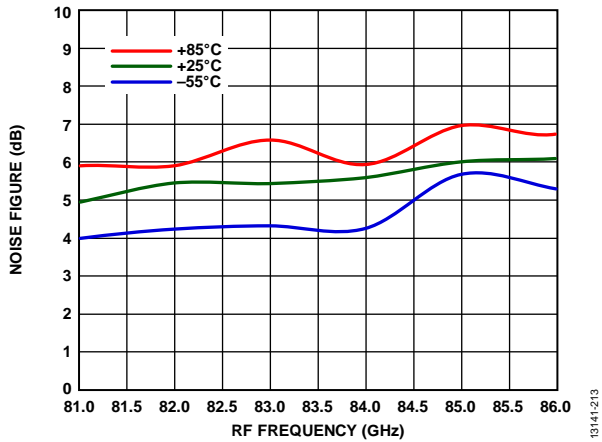

Figure 193. Noise Figure vs. RF Frequency at Various Temperatures, LO = 2 dBm, IF = 1000 MHz, V<sub>DLNA</sub> = 3 V

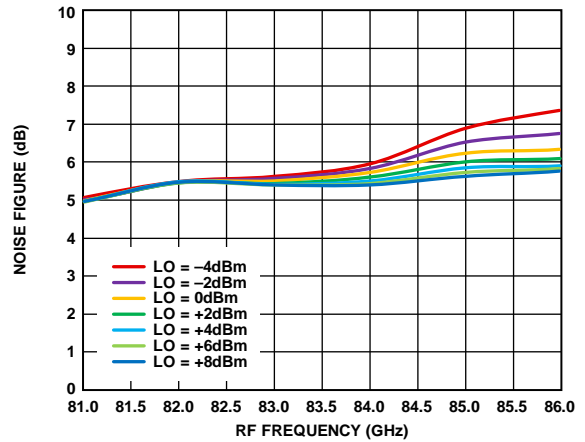

Figure 196. Noise Figure vs. RF Frequency at Various LO Powers, RFIN = -20 dBm, IF = 500 MHz, V<sub>DLNA</sub> = 3 V

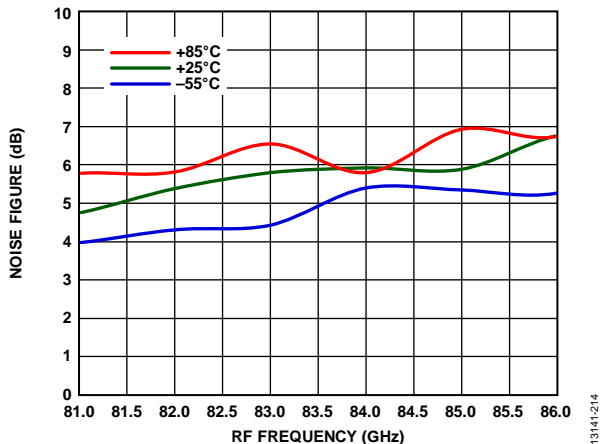

Figure 194. Noise Figure vs. RF Frequency at Various Temperatures, LO = 2 dBm, IF = 2000 MHz, V<sub>DLNA</sub> = 3 V

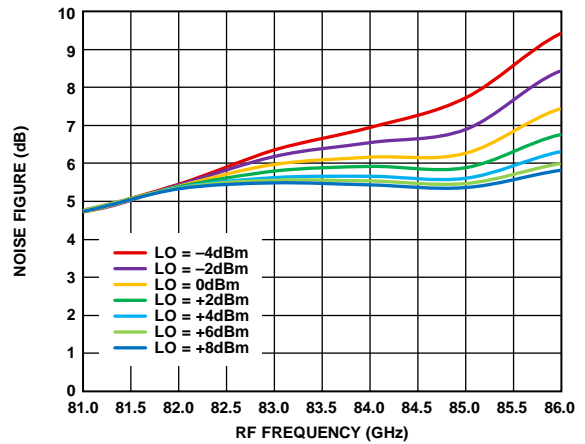

Figure 197. Noise Figure vs. RF Frequency at Various LO Powers, IF = 2000 MHz, V<sub>DLNA</sub> = 3 V

AMPLITUDE BALANCE PERFORMANCE WITH LOWER SIDEBAND SELECTED

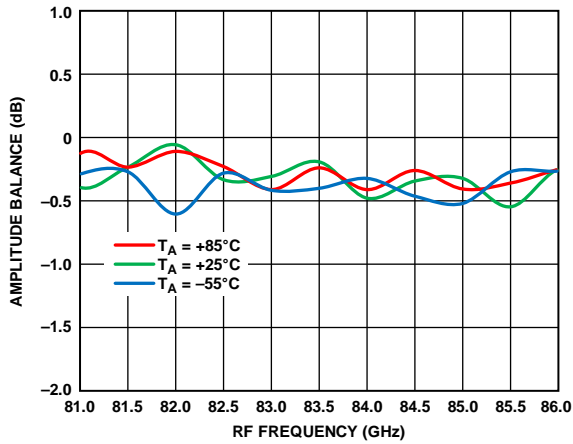

Figure 198. Amplitude Balance vs. RF Frequency at Various Temperatures, RFIN = -20 dBm, LO = 2 dBm, IF = 500 MHz, V<sub>DLNA</sub> = 4 V

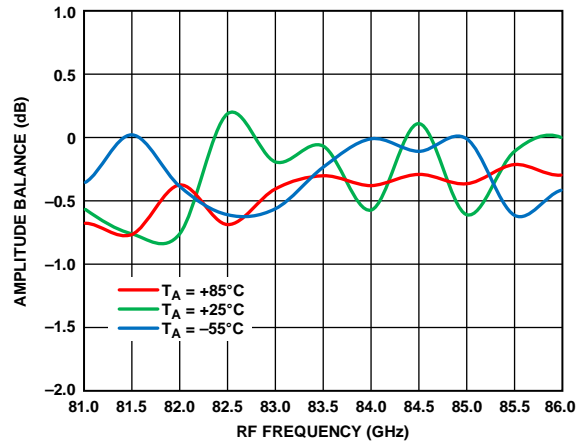

Figure 201. Amplitude Balance vs. RF Frequency at Various Temperatures, RFIN = -20 dBm, LO = 2 dBm, IF = 500 MHz, V<sub>DLNA</sub> = 3 V

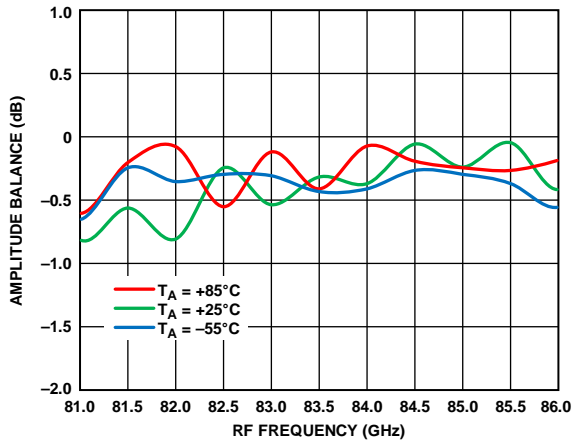

Figure 199. Amplitude Balance vs. RF Frequency at Various Temperatures, RFIN = -20 dBm, LO = 2 dBm, IF = 1000 MHz, V<sub>DLNA</sub> = 4 V

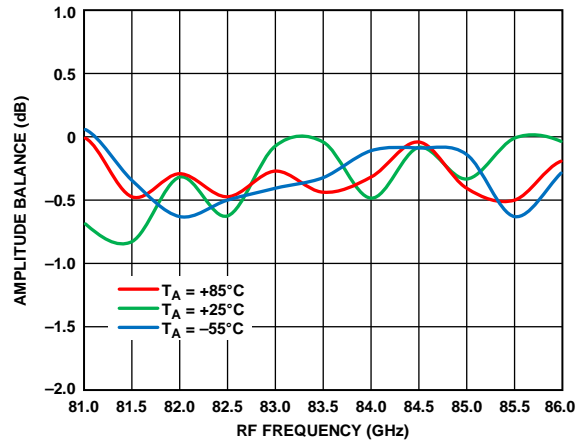

Figure 202. Amplitude Balance vs. RF Frequency at Various Temperatures, RFIN = -20 dBm, LO = 2 dBm, IF = 1000 MHz, V<sub>DLNA</sub> = 3 V

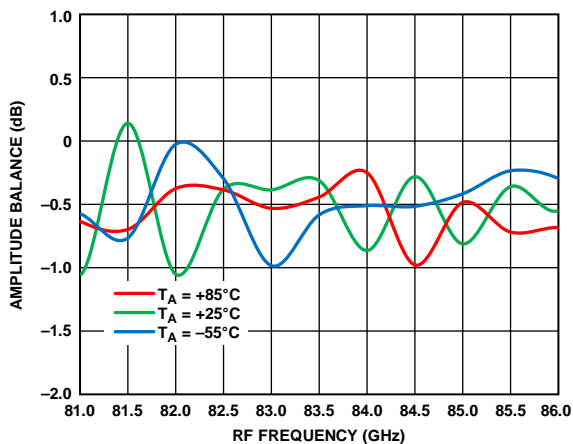

Figure 200. Amplitude Balance vs. RF Frequency at Various Temperatures, RFIN = -20 dBm, LO = 2 dBm, IF = 2000 MHz, V<sub>DLNA</sub> = 4 V

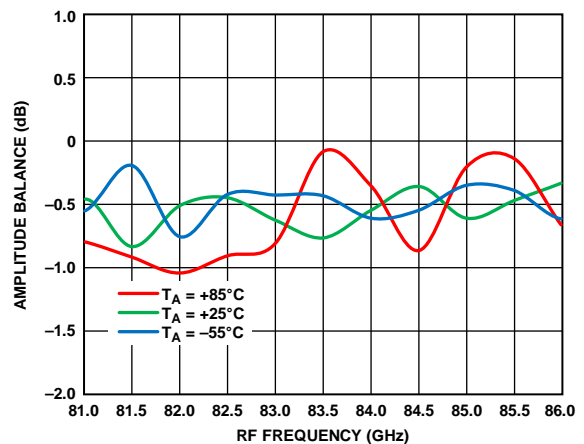

Figure 203. Amplitude Balance vs. RF Frequency at Various Temperatures, RFIN = -20 dBm, LO = 2 dBm, IF = 2000 MHz, V<sub>DLNA</sub> = 3 V

PHASE BALANCE PERFORMANCE WITH LOWER SIDEBAND SELECTED

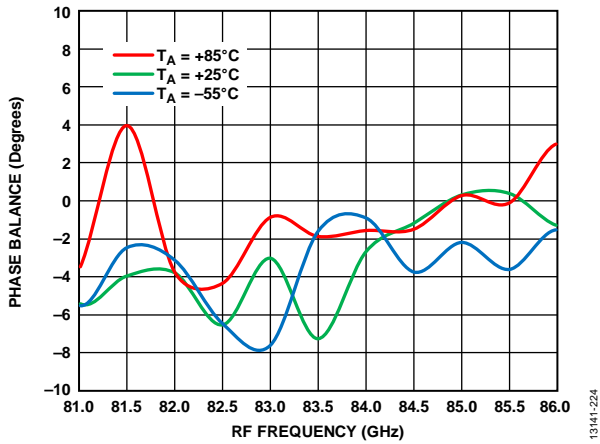

Figure 204. Phase Balance vs. RF Frequency at Various Temperatures, RFIN = -20 dBm, LO = 2 dBm, IF = 500 MHz, VDLNA = 4 V

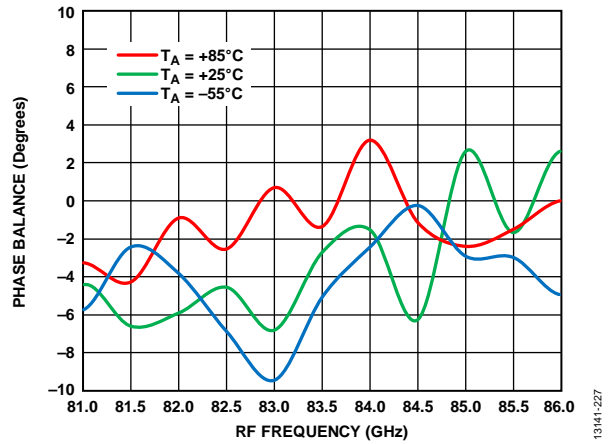

Figure 207. Phase Balance vs. RF Frequency at Various Temperatures, RFIN = -20 dBm, LO = 2 dBm, IF = 500 MHz, VDLNA = 3 V

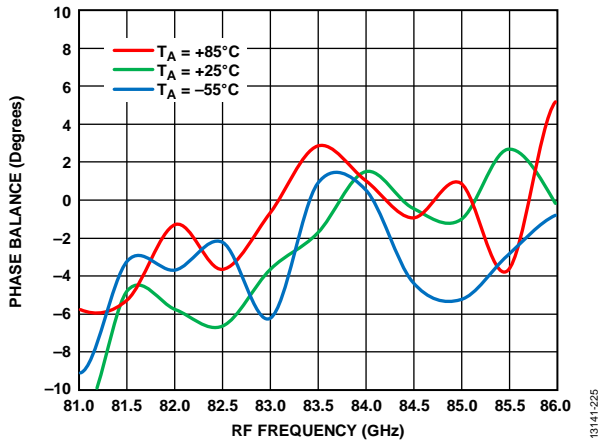

Figure 205. Phase Balance vs. RF Frequency at Various Temperatures, RFIN = -20 dBm, LO = 2 dBm, IF = 1000 MHz, VDLNA = 4 V

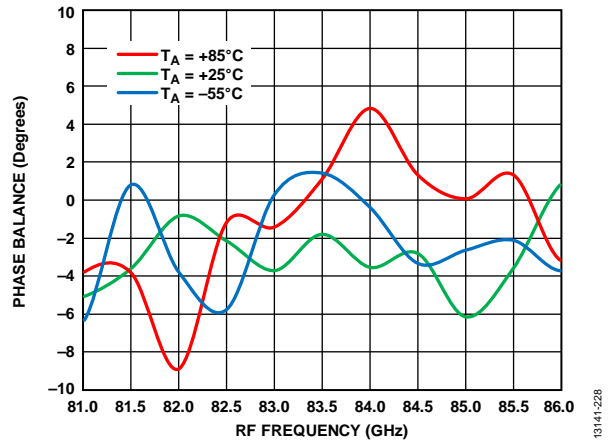

Figure 208. Phase Balance vs. RF Frequency at Various Temperatures, RFIN = -20 dBm, LO = 2 dBm, IF = 1000 MHz, VDLNA = 3 V

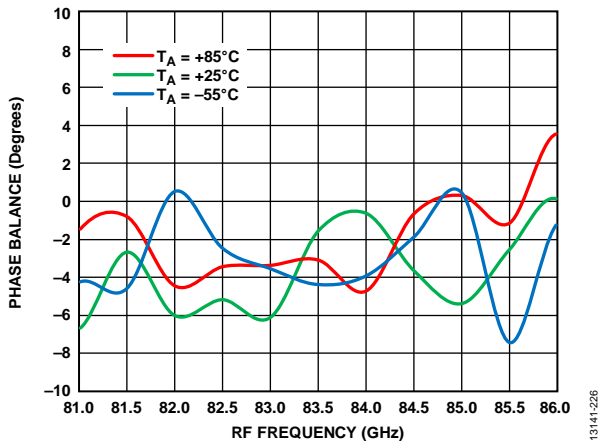

Figure 206. Phase Balance vs. RF Frequency at Various Temperatures, RFIN = -20 dBm, LO = 2 dBm, IF = 2000 MHz, VDLNA = 4 V

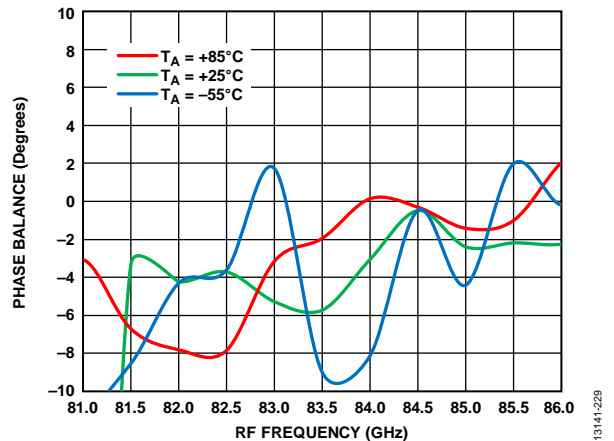

Figure 209. Phase Balance vs. RF Frequency at Various Temperatures, RFIN = -20 dBm, LO = 2 dBm, IF = 2000 MHz, VDLNA = 3 V

## SPURIOUS PERFORMANCE WITH UPPER SIDEBAND SELECTED, IF = 500 MHz

$T_A = 25^\circ\text{C}$ ,  $V_{\text{GMIX}} = -1\text{ V}$ ,  $V_{\text{DAMPx}} = 4\text{ V}$ ,  $V_{\text{DMULT}} = 1.5\text{ V}$ ,  
 $\text{LOIN} = 2\text{ dBm}$ .

Mixer spurious products are measured in dBc from the IF output power level. Spur values are  $(M \times \text{RF}) - (N \times \text{LO})$ . N/A means not applicable.

### $M \times N$ Spurious Outputs, $V_{\text{DLNA}} = 4\text{ V}$

RF = 81 GHz at  $\text{RFIN} = -10\text{ dBm}$ , LO frequency = 13.416 GHz at  $\text{LOIN} = 2\text{ dBm}$ .

		N × LO						
		0	1	2	3	4	5	6
M × RF	0	N/A	N/A	N/A	N/A	N/A	N/A	N/A
	1	N/A	N/A	N/A	N/A	N/A	N/A	N/A
	2	N/A	N/A	29.2	N/A	N/A	N/A	N/A
	3	N/A	N/A	N/A	39	N/A	N/A	N/A
	4	N/A	N/A	N/A	N/A	57	N/A	N/A
	5	N/A	N/A	N/A	N/A	N/A	59.7	N/A

RF = 83 GHz at  $\text{RFIN} = -10\text{ dBm}$ , LO frequency = 13.75 GHz at  $\text{LOIN} = 2\text{ dBm}$ .

		N × LO						
		0	1	2	3	4	5	6
M × RF	0	N/A	N/A	N/A	N/A	N/A	N/A	N/A
	1	N/A	N/A	N/A	N/A	N/A	N/A	N/A
	2	N/A	N/A	25	N/A	N/A	N/A	N/A
	3	N/A	N/A	N/A	36.6	N/A	N/A	N/A
	4	N/A	N/A	N/A	N/A	49.3	N/A	N/A
	5	N/A	N/A	N/A	N/A	N/A	53.9	N/A

RF = 86 GHz at  $\text{RFIN} = -10\text{ dBm}$ , LO frequency = 14.25 GHz at  $\text{LOIN} = 2\text{ dBm}$ .

		N × LO						
		0	1	2	3	4	5	6
M × RF	0	N/A	N/A	N/A	N/A	N/A	N/A	N/A
	1	N/A	N/A	N/A	N/A	N/A	N/A	N/A
	2	N/A	N/A	29.6	N/A	N/A	N/A	N/A
	3	N/A	N/A	N/A	43.1	N/A	N/A	N/A
	4	N/A	N/A	N/A	N/A	61.2	N/A	N/A
	5	N/A	N/A	N/A	N/A	N/A	63.5	N/A

### $M \times N$ Spurious Outputs, $V_{\text{DLNA}} = 3\text{ V}$

RF = 81 GHz at  $\text{RFIN} = -10\text{ dBm}$ , LO frequency = 13.416 GHz at  $\text{LOIN} = 2\text{ dBm}$ .

		N × LO						
		0	1	2	3	4	5	6
M × RF	0	N/A	N/A	N/A	N/A	N/A	N/A	N/A
	1	N/A	N/A	N/A	N/A	N/A	N/A	N/A
	2	N/A	N/A	30.3	N/A	N/A	N/A	N/A
	3	N/A	N/A	N/A	41.5	N/A	N/A	N/A
	4	N/A	N/A	N/A	N/A	59.4	N/A	N/A
	5	N/A	N/A	N/A	N/A	N/A	64	N/A

RF = 83 GHz at  $\text{RFIN} = -10\text{ dBm}$ , LO frequency = 13.75 MHz at  $\text{LOIN} = 2\text{ dBm}$ .

		N × LO						
		0	1	2	3	4	5	6
M × RF	0	N/A	N/A	N/A	N/A	N/A	N/A	N/A
	1	N/A	N/A	N/A	N/A	N/A	N/A	N/A
	2	N/A	N/A	26	N/A	N/A	N/A	N/A
	3	N/A	N/A	N/A	38.7	N/A	N/A	N/A
	4	N/A	N/A	N/A	N/A	52.1	N/A	N/A
	5	N/A	N/A	N/A	N/A	N/A	57.2	N/A

RF = 86 GHz at  $\text{RFIN} = -10\text{ dBm}$ , LO frequency = 14.25 GHz at  $\text{LOIN} = 2\text{ dBm}$ .

		N × LO						
		0	1	2	3	4	5	6
M × RF	0	N/A	N/A	N/A	N/A	N/A	N/A	N/A
	1	N/A	N/A	N/A	N/A	N/A	N/A	N/A
	2	N/A	N/A	30.1	N/A	N/A	N/A	N/A
	3	N/A	N/A	N/A	45.4	N/A	N/A	N/A
	4	N/A	N/A	N/A	N/A	62.9	N/A	N/A
	5	N/A	N/A	N/A	N/A	N/A	67.3	N/A

**SPURIOUS PERFORMANCE WITH UPPER SIDEBAND SELECTED, IF = 1000 MHz**

$T_A = 25^\circ\text{C}$ ,  $V_{\text{GMIX}} = -1\text{ V}$ ,  $V_{\text{DAMPx}} = 4\text{ V}$ ,  $V_{\text{DMULT}} = 1.5\text{ V}$ ,  $\text{LOIN} = 2\text{ dBm}$ .

Mixer spurious products are measured in dBc from the IF output power level. Spur values are  $(M \times \text{RF}) - (N \times \text{LO})$ . N/A means not applicable.

**$M \times N$  Spurious Outputs,  $V_{\text{DLNA}} = 4\text{ V}$**

RF = 81 GHz at  $\text{RFIN} = -10\text{ dBm}$ , LO frequency = 13.333 GHz at  $\text{LOIN} = 2\text{ dBm}$ .

		N × LO						
		0	1	2	3	4	5	6
M × RF	0	N/A	N/A	N/A	N/A	N/A	N/A	N/A
	1	N/A	N/A	N/A	N/A	N/A	N/A	N/A
	2	N/A	N/A	28.4	N/A	N/A	N/A	N/A
	3	N/A	N/A	N/A	38.9	N/A	N/A	N/A
	4	N/A	N/A	N/A	N/A	56.5	N/A	N/A
	5	N/A	N/A	N/A	N/A	N/A	59.3	N/A

RF = 83 GHz at  $\text{RFIN} = -10\text{ dBm}$ , LO frequency = 13.666 MHz at  $\text{LOIN} = 2\text{ dBm}$ .

		N × LO						
		0	1	2	3	4	5	6
M × RF	0	N/A	N/A	N/A	N/A	N/A	N/A	N/A
	1	N/A	N/A	N/A	N/A	N/A	N/A	N/A
	2	N/A	N/A	26.5	N/A	N/A	N/A	N/A
	3	N/A	N/A	N/A	37.1	N/A	N/A	N/A
	4	N/A	N/A	N/A	N/A	52.8	N/A	N/A
	5	N/A	N/A	N/A	N/A	N/A	56.7	N/A

RF = 86 GHz at  $\text{RFIN} = -10\text{ dBm}$ , LO frequency = 14.166 GHz at  $\text{LOIN} = 2\text{ dBm}$ .

		N × LO						
		0	1	2	3	4	5	6
M × RF	0	N/A	N/A	N/A	N/A	N/A	N/A	N/A
	1	N/A	N/A	N/A	N/A	N/A	N/A	N/A
	2	N/A	N/A	27.9	N/A	N/A	N/A	N/A
	3	N/A	N/A	N/A	42	N/A	N/A	N/A
	4	N/A	N/A	N/A	N/A	60.2	N/A	N/A
	5	N/A	N/A	N/A	N/A	N/A	62.7	N/A

**$M \times N$  Spurious Outputs,  $V_{\text{DLNA}} = 3\text{ V}$**

RF = 81 GHz at  $\text{RFIN} = -10\text{ dBm}$ , LO frequency = 13.333 GHz at  $\text{LOIN} = 2\text{ dBm}$ .

		N × LO						
		0	1	2	3	4	5	6
M × RF	0	N/A	N/A	N/A	N/A	N/A	N/A	N/A
	1	N/A	N/A	N/A	N/A	N/A	N/A	N/A
	2	N/A	N/A	29.7	N/A	N/A	N/A	N/A
	3	N/A	N/A	N/A	41.7	N/A	N/A	N/A
	4	N/A	N/A	N/A	N/A	58.7	N/A	N/A
	5	N/A	N/A	N/A	N/A	N/A	63.4	N/A

RF = 83 GHz at  $\text{RFIN} = -10\text{ dBm}$ , LO frequency = 13.666 MHz at  $\text{LOIN} = 2\text{ dBm}$ .

		N × LO						
		0	1	2	3	4	5	6
M × RF	0	N/A	N/A	N/A	N/A	N/A	N/A	N/A
	1	N/A	N/A	N/A	N/A	N/A	N/A	N/A
	2	N/A	N/A	27.5	N/A	N/A	N/A	N/A
	3	N/A	N/A	N/A	39.3	N/A	N/A	N/A
	4	N/A	N/A	N/A	N/A	55.1	N/A	N/A
	5	N/A	N/A	N/A	N/A	N/A	60.4	N/A

RF = 86 GHz at  $\text{RFIN} = -10\text{ dBm}$ , LO frequency = 14.166 GHz at  $\text{LOIN} = 2\text{ dBm}$ .

		N × LO						
		0	1	2	3	4	5	6
M × RF	0	N/A	N/A	N/A	N/A	N/A	N/A	N/A
	1	N/A	N/A	N/A	N/A	N/A	N/A	N/A
	2	N/A	N/A	28.8	N/A	N/A	N/A	N/A
	3	N/A	N/A	N/A	44.2	N/A	N/A	N/A
	4	N/A	N/A	N/A	N/A	62.1	N/A	N/A
	5	N/A	N/A	N/A	N/A	N/A	66.6	N/A

## SPURIOUS PERFORMANCE WITH UPPER SIDEBAND SELECTED, IF = 2000 MHz

$T_A = 25^\circ\text{C}$ ,  $V_{\text{GMIX}} = -1\text{ V}$ ,  $V_{\text{DAMPx}} = 4\text{ V}$ ,  $V_{\text{DMULT}} = 1.5\text{ V}$ ,  $\text{LOIN} = 2\text{ dBm}$ .

Mixer spurious products are measured in dBc from the IF output power level. Spur values are  $(M \times \text{RF}) - (N \times \text{LO})$ . N/A means not applicable.

### $M \times N$ Spurious Outputs, $V_{\text{DLNA}} = 4\text{ V}$

RF = 81 GHz at  $\text{RFIN} = -10\text{ dBm}$ , LO frequency = 13.166 GHz at  $\text{LOIN} = 2\text{ dBm}$ .

		N × LO						
		0	1	2	3	4	5	6
M × RF	0	N/A	N/A	N/A	N/A	N/A	N/A	N/A
	1	N/A	N/A	N/A	N/A	N/A	N/A	N/A
	2	N/A	N/A	28.1	N/A	N/A	N/A	N/A
	3	N/A	N/A	N/A	42	N/A	N/A	N/A
	4	N/A	N/A	N/A	N/A	56.3	N/A	N/A
	5	N/A	N/A	N/A	N/A	N/A	61.1	N/A

RF = 83 GHz at  $\text{RFIN} = -10\text{ dBm}$ , LO frequency = 13.5 MHz at  $\text{LOIN} = 2\text{ dBm}$ .

		N × LO						
		0	1	2	3	4	5	6
M × RF	0	N/A	N/A	N/A	N/A	N/A	N/A	N/A
	1	N/A	N/A	N/A	N/A	N/A	N/A	N/A
	2	N/A	N/A	27.8	N/A	N/A	N/A	N/A
	3	N/A	N/A	N/A	38.5	N/A	N/A	N/A
	4	N/A	N/A	N/A	N/A	55.6	N/A	N/A
	5	N/A	N/A	N/A	N/A	N/A	60.8	N/A

RF = 86 GHz at  $\text{RFIN} = -10\text{ dBm}$ , LO frequency = 14 GHz at  $\text{LOIN} = 2\text{ dBm}$ .

		N × LO						
		0	1	2	3	4	5	6
M × RF	0	N/A	N/A	N/A	N/A	N/A	N/A	N/A
	1	N/A	N/A	N/A	N/A	N/A	N/A	N/A
	2	N/A	N/A	25.1	N/A	N/A	N/A	N/A
	3	N/A	N/A	N/A	38.5	N/A	N/A	N/A
	4	N/A	N/A	N/A	N/A	52.9	N/A	N/A
	5	N/A	N/A	N/A	N/A	N/A	52.3	N/A

### $M \times N$ Spurious Outputs, $V_{\text{DLNA}} = 3\text{ V}$

RF = 81 GHz at  $\text{RFIN} = -10\text{ dBm}$ , LO frequency = 13.166 GHz at  $\text{LOIN} = 2\text{ dBm}$ .

		N × LO						
		0	1	2	3	4	5	6
M × RF	0	N/A	N/A	N/A	N/A	N/A	N/A	N/A
	1	N/A	N/A	N/A	N/A	N/A	N/A	N/A
	2	N/A	N/A	29.6	N/A	N/A	N/A	N/A
	3	N/A	N/A	N/A	45.1	N/A	N/A	N/A
	4	N/A	N/A	N/A	N/A	58.7	N/A	N/A
	5	N/A	N/A	N/A	N/A	N/A	65.5	N/A

RF = 83 GHz at  $\text{RFIN} = -10\text{ dBm}$ , LO frequency = 13.5 MHz at  $\text{LOIN} = 2\text{ dBm}$ .

		N × LO						
		0	1	2	3	4	5	6
M × RF	0	N/A	N/A	N/A	N/A	N/A	N/A	N/A
	1	N/A	N/A	N/A	N/A	N/A	N/A	N/A
	2	N/A	N/A	28.8	N/A	N/A	N/A	N/A
	3	N/A	N/A	N/A	41	N/A	N/A	N/A
	4	N/A	N/A	N/A	N/A	58.6	N/A	N/A
	5	N/A	N/A	N/A	N/A	N/A	64.7	N/A

RF = 86 GHz at  $\text{RFIN} = -10\text{ dBm}$ , LO frequency = 14 GHz at  $\text{LOIN} = 2\text{ dBm}$ .

		N × LO						
		0	1	2	3	4	5	6
M × RF	0	N/A	N/A	N/A	N/A	N/A	N/A	N/A
	1	N/A	N/A	N/A	N/A	N/A	N/A	N/A
	2	N/A	N/A	26	N/A	N/A	N/A	N/A
	3	N/A	N/A	N/A	40.7	N/A	N/A	N/A
	4	N/A	N/A	N/A	N/A	56.5	N/A	N/A
	5	N/A	N/A	N/A	N/A	N/A	54.2	N/A

**SPURIOUS PERFORMANCE WITH LOWER SIDEBAND SELECTED, IF = 500 MHz**

$T_A = 25^\circ\text{C}$ ,  $V_{\text{GMIX}} = -1\text{ V}$ ,  $V_{\text{DAMPx}} = 4\text{ V}$ ,  $V_{\text{DMULT}} = 1.5\text{ V}$ ,  $\text{LOIN} = 2\text{ dBm}$ .

Mixer spurious products are measured in dBc from the IF output power level. Spur values are  $(M \times \text{RF}) - (N \times \text{LO})$ . N/A means not applicable.

**$M \times N$  Spurious Outputs,  $V_{\text{DLNA}} = 4\text{ V}$**

RF = 81 GHz at  $\text{RFIN} = -10\text{ dBm}$ , LO frequency = 13.583 GHz at  $\text{LOIN} = 2\text{ dBm}$ .

		N × LO						
		0	1	2	3	4	5	6
M × RF	0	N/A	N/A	N/A	N/A	N/A	N/A	N/A
	1	N/A	N/A	N/A	N/A	N/A	N/A	N/A
	2	N/A	N/A	27.6	N/A	N/A	N/A	N/A
	3	N/A	N/A	N/A	38.5	N/A	N/A	N/A
	4	N/A	N/A	N/A	N/A	52.8	N/A	N/A
	5	N/A	N/A	N/A	N/A	N/A	55.9	N/A

RF = 83 GHz at  $\text{RFIN} = -10\text{ dBm}$ , LO frequency = 13.916 GHz at  $\text{LOIN} = 2\text{ dBm}$ .

		N × LO						
		0	1	2	3	4	5	6
M × RF	0	N/A	N/A	N/A	N/A	N/A	N/A	N/A
	1	N/A	N/A	N/A	N/A	N/A	N/A	N/A
	2	N/A	N/A	25.4	N/A	N/A	N/A	N/A
	3	N/A	N/A	N/A	38.3	N/A	N/A	N/A
	4	N/A	N/A	N/A	N/A	49.2	N/A	N/A
	5	N/A	N/A	N/A	N/A	N/A	55.1	N/A

RF = 86 GHz at  $\text{RFIN} = -10\text{ dBm}$ , LO frequency = 14.416 GHz at  $\text{LOIN} = 2\text{ dBm}$ .

		N × LO						
		0	1	2	3	4	5	6
M × RF	0	N/A	N/A	N/A	N/A	N/A	N/A	N/A
	1	N/A	N/A	N/A	N/A	N/A	N/A	N/A
	2	N/A	N/A	28.9	N/A	N/A	N/A	N/A
	3	N/A	N/A	N/A	44.8	N/A	N/A	N/A
	4	N/A	N/A	N/A	N/A	59.1	N/A	N/A
	5	N/A	N/A	N/A	N/A	N/A	64.8	N/A

**$M \times N$  Spurious Outputs,  $V_{\text{DLNA}} = 3\text{ V}$**

RF = 81 GHz at  $\text{RFIN} = -10\text{ dBm}$ , LO frequency = 13.583 GHz at  $\text{LOIN} = 2\text{ dBm}$ .

		N × LO						
		0	1	2	3	4	5	6
M × RF	0	N/A	N/A	N/A	N/A	N/A	N/A	N/A
	1	N/A	N/A	N/A	N/A	N/A	N/A	N/A
	2	N/A	N/A	28.5	N/A	N/A	N/A	N/A
	3	N/A	N/A	N/A	40.6	N/A	N/A	N/A
	4	N/A	N/A	N/A	N/A	55.6	N/A	N/A
	5	N/A	N/A	N/A	N/A	N/A	59.8	N/A

RF = 83 GHz at  $\text{RFIN} = -10\text{ dBm}$ , LO frequency = 13.916 MHz at  $\text{LOIN} = 2\text{ dBm}$ .

		N × LO						
		0	1	2	3	4	5	6
M × RF	0	N/A	N/A	N/A	N/A	N/A	N/A	N/A
	1	N/A	N/A	N/A	N/A	N/A	N/A	N/A
	2	N/A	N/A	26.3	N/A	N/A	N/A	N/A
	3	N/A	N/A	N/A	40	N/A	N/A	N/A
	4	N/A	N/A	N/A	N/A	52.1	N/A	N/A
	5	N/A	N/A	N/A	N/A	N/A	58.3	N/A

RF = 86 GHz at  $\text{RFIN} = -10\text{ dBm}$ , LO frequency = 14.416 GHz at  $\text{LOIN} = 2\text{ dBm}$ .

		N × LO						
		0	1	2	3	4	5	6
M × RF	0	N/A	N/A	N/A	N/A	N/A	N/A	N/A
	1	N/A	N/A	N/A	N/A	N/A	N/A	N/A
	2	N/A	N/A	28.8	N/A	N/A	N/A	N/A
	3	N/A	N/A	N/A	46.5	N/A	N/A	N/A
	4	N/A	N/A	N/A	N/A	61.6	N/A	N/A
	5	N/A	N/A	N/A	N/A	N/A	68.5	N/A

## SPURIOUS PERFORMANCE WITH LOWER SIDEBAND SELECTED, IF = 1000 MHz

$T_A = 25^\circ\text{C}$ ,  $V_{\text{GMIX}} = -1\text{ V}$ ,  $V_{\text{DAMPx}} = 4\text{ V}$ ,  $V_{\text{DMULT}} = 1.5\text{ V}$ ,  $\text{LOIN} = 2\text{ dBm}$ .

Mixer spurious products are measured in dBc from the IF output power level. Spur values are  $(M \times \text{RF}) - (N \times \text{LO})$ . N/A means not applicable.

### $M \times N$ Spurious Outputs, $V_{\text{DLNA}} = 4\text{ V}$

RF = 81 GHz at  $\text{RFIN} = -10\text{ dBm}$ , LO frequency = 13.666 GHz at  $\text{LOIN} = 2\text{ dBm}$ .

		N × LO						
		0	1	2	3	4	5	6
M × RF	0	N/A	N/A	N/A	N/A	N/A	N/A	N/A
	1	N/A	N/A	N/A	N/A	N/A	N/A	N/A
	2	N/A	N/A	26.5	N/A	N/A	N/A	N/A
	3	N/A	N/A	N/A	37.1	N/A	N/A	N/A
	4	N/A	N/A	N/A	N/A	51	N/A	N/A
	5	N/A	N/A	N/A	N/A	N/A	55.6	N/A

RF = 83 GHz at  $\text{RFIN} = -10\text{ dBm}$ , LO frequency = 14 GHz at  $\text{LOIN} = 2\text{ dBm}$ .

		N × LO						
		0	1	2	3	4	5	6
M × RF	0	N/A	N/A	N/A	N/A	N/A	N/A	N/A
	1	N/A	N/A	N/A	N/A	N/A	N/A	N/A
	2	N/A	N/A	26.5	N/A	N/A	N/A	N/A
	3	N/A	N/A	N/A	40	N/A	N/A	N/A
	4	N/A	N/A	N/A	N/A	50.8	N/A	N/A
	5	N/A	N/A	N/A	N/A	N/A	59.4	N/A

RF = 86 GHz at  $\text{RFIN} = -10\text{ dBm}$ , LO frequency = 14.5 GHz at  $\text{LOIN} = 2\text{ dBm}$ .

		N × LO						
		0	1	2	3	4	5	6
M × RF	0	N/A	N/A	N/A	N/A	N/A	N/A	N/A
	1	N/A	N/A	N/A	N/A	N/A	N/A	N/A
	2	N/A	N/A	27.7	N/A	N/A	N/A	N/A
	3	N/A	N/A	N/A	42.8	N/A	N/A	N/A
	4	N/A	N/A	N/A	N/A	56.9	N/A	N/A
	5	N/A	N/A	N/A	N/A	N/A	68.1	N/A

### $M \times N$ Spurious Outputs, $V_{\text{DLNA}} = 3\text{ V}$

RF = 81 GHz at  $\text{RFIN} = -10\text{ dBm}$ , LO frequency = 13.666 GHz at  $\text{LOIN} = 2\text{ dBm}$ .

		N × LO						
		0	1	2	3	4	5	6
M × RF	0	N/A	N/A	N/A	N/A	N/A	N/A	N/A
	1	N/A	N/A	N/A	N/A	N/A	N/A	N/A
	2	N/A	N/A	27.6	N/A	N/A	N/A	N/A
	3	N/A	N/A	N/A	39.2	N/A	N/A	N/A
	4	N/A	N/A	N/A	N/A	53.4	N/A	N/A
	5	N/A	N/A	N/A	N/A	N/A	59.1	N/A

RF = 83 GHz at  $\text{RFIN} = -10\text{ dBm}$ , LO frequency = 14 GHz at  $\text{LOIN} = 2\text{ dBm}$ .

		N × LO						
		0	1	2	3	4	5	6
M × RF	0	N/A	N/A	N/A	N/A	N/A	N/A	N/A
	1	N/A	N/A	N/A	N/A	N/A	N/A	N/A
	2	N/A	N/A	27.4	N/A	N/A	N/A	N/A
	3	N/A	N/A	N/A	41.8	N/A	N/A	N/A
	4	N/A	N/A	N/A	N/A	54.9	N/A	N/A
	5	N/A	N/A	N/A	N/A	N/A	62.9	N/A

RF = 86 GHz at  $\text{RFIN} = -10\text{ dBm}$ , LO frequency = 14.5 GHz at  $\text{LOIN} = 2\text{ dBm}$ .

		N × LO						
		0	1	2	3	4	5	6
M × RF	0	N/A	N/A	N/A	N/A	N/A	N/A	N/A
	1	N/A	N/A	N/A	N/A	N/A	N/A	N/A
	2	N/A	N/A	28.1	N/A	N/A	N/A	N/A
	3	N/A	N/A	N/A	45.2	N/A	N/A	N/A
	4	N/A	N/A	N/A	N/A	60.3	N/A	N/A
	5	N/A	N/A	N/A	N/A	N/A	73.2	N/A



**SPURIOUS PERFORMANCE WITH LOWER SIDEBAND SELECTED, IF = 2000 MHz**

$T_A = 25^\circ\text{C}$ ,  $V_{\text{GMIX}} = -1\text{ V}$ ,  $V_{\text{DAMPx}} = 4\text{ V}$ ,  $V_{\text{DMULT}} = 1.5\text{ V}$ ,  $\text{LOIN} = 2\text{ dBm}$ .

Mixer spurious products are measured in dBc from the IF output power level. Spur values are  $(M \times \text{RF}) - (N \times \text{LO})$ . N/A means not applicable.

**$M \times N$  Spurious Outputs,  $V_{\text{DLNA}} = 4\text{ V}$**

RF = 81 GHz at  $\text{RFIN} = -10\text{ dBm}$ , LO frequency = 13.833 GHz at  $\text{LOIN} = 2\text{ dBm}$ .

		N x LO						
		0	1	2	3	4	5	6
M x RF	0	N/A	N/A	N/A	N/A	N/A	N/A	N/A
	1	N/A	N/A	N/A	N/A	N/A	N/A	N/A
	2	N/A	N/A	25.1	N/A	N/A	N/A	N/A
	3	N/A	N/A	N/A	38.3	N/A	N/A	N/A
	4	N/A	N/A	N/A	N/A	48	N/A	N/A
	5	N/A	N/A	N/A	N/A	N/A	56.5	N/A

RF = 83 GHz at  $\text{RFIN} = -10\text{ dBm}$ , LO frequency = 14.166 GHz at  $\text{LOIN} = 2\text{ dBm}$ .

		N x LO						
		0	1	2	3	4	5	6
M x RF	0	N/A	N/A	N/A	N/A	N/A	N/A	N/A
	1	N/A	N/A	N/A	N/A	N/A	N/A	N/A
	2	N/A	N/A	27.9	N/A	N/A	N/A	N/A
	3	N/A	N/A	N/A	43.2	N/A	N/A	N/A
	4	N/A	N/A	N/A	N/A	56.2	N/A	N/A
	5	N/A	N/A	N/A	N/A	N/A	65.4	N/A

RF = 86 GHz at  $\text{RFIN} = -10\text{ dBm}$ , LO frequency = 14.666 GHz at  $\text{LOIN} = 2\text{ dBm}$ .

		N x LO						
		0	1	2	3	4	5	6
M x RF	0	N/A	N/A	N/A	N/A	N/A	N/A	N/A
	1	N/A	N/A	N/A	N/A	N/A	N/A	N/A
	2	N/A	N/A	22.3	N/A	N/A	N/A	N/A
	3	N/A	N/A	N/A	40.1	N/A	N/A	N/A
	4	N/A	N/A	N/A	N/A	48.1	N/A	N/A
	5	N/A	N/A	N/A	N/A	N/A	63	N/A

**$M \times N$  Spurious Outputs,  $V_{\text{DLNA}} = 3\text{ V}$**

RF = 81 GHz at  $\text{RFIN} = -10\text{ dBm}$ , LO frequency = 13.833 GHz at  $\text{LOIN} = 2\text{ dBm}$ .

		N x LO						
		0	1	2	3	4	5	6
M x RF	0	N/A	N/A	N/A	N/A	N/A	N/A	N/A
	1	N/A	N/A	N/A	N/A	N/A	N/A	N/A
	2	N/A	N/A	25.9	N/A	N/A	N/A	N/A
	3	N/A	N/A	N/A	39.5	N/A	N/A	N/A
	4	N/A	N/A	N/A	N/A	51.8	N/A	N/A
	5	N/A	N/A	N/A	N/A	N/A	59.5	N/A

RF = 83 GHz at  $\text{RFIN} = -10\text{ dBm}$ , LO frequency = 14.166 GHz at  $\text{LOIN} = 2\text{ dBm}$ .

		N x LO						
		0	1	2	3	4	5	6
M x RF	0	N/A	N/A	N/A	N/A	N/A	N/A	N/A
	1	N/A	N/A	N/A	N/A	N/A	N/A	N/A
	2	N/A	N/A	28.9	N/A	N/A	N/A	N/A
	3	N/A	N/A	N/A	45.6	N/A	N/A	N/A
	4	N/A	N/A	N/A	N/A	60	N/A	N/A
	5	N/A	N/A	N/A	N/A	N/A	63.9	N/A

RF = 86 GHz at  $\text{RFIN} = -10\text{ dBm}$ , LO frequency = 14.666 GHz at  $\text{LOIN} = 2\text{ dBm}$ .

		N x LO						
		0	1	2	3	4	5	6
M x RF	0	N/A	N/A	N/A	N/A	N/A	N/A	N/A
	1	N/A	N/A	N/A	N/A	N/A	N/A	N/A
	2	N/A	N/A	23.2	N/A	N/A	N/A	N/A
	3	N/A	N/A	N/A	42.3	N/A	N/A	N/A
	4	N/A	N/A	N/A	N/A	51	N/A	N/A
	5	N/A	N/A	N/A	N/A	N/A	67	N/A

### THEORY OF OPERATION

The HMC7587 is a GaAs low noise I/Q downconverter with an integrated LO buffer and a 6x multiplier. See Figure 210 for a functional block diagram of the downconverter circuit architecture.

The RF input is internally ac-coupled and matched to 50 Ω. The input passes through four stages of low noise amplification. The preamplified RF input signal then splits and drives two singly balanced passive mixers.

Quadrature LO signals drive the two I and Q mixer cores. The LO path provides a 6x multiplier that allows the use of a lower frequency range LO input signal, typically between 11.83 GHz and 14.33 GHz. The 6x multiplier is implemented using a cascade of 3x and 2x multipliers. The LO buffer amplifiers are included on-chip to allow a typical LO drive level of only 2 dBm for full performance.

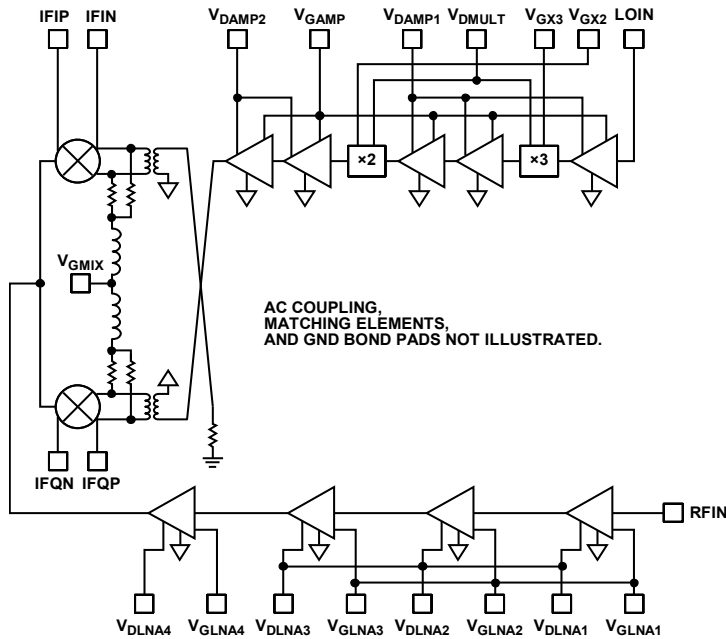

Figure 210. Downconverter Circuit Architecture

13141-230

# APPLICATIONS INFORMATION

## BIASING SEQUENCE

The HMC7587 uses several amplifier and multiplier stages. The active stages all use depletion mode pseudomorphic high electron mobility transistors (pHEMTs). To ensure transistor damage does not occur, use the following power-up bias sequence:

1. Apply a  $-2\text{ V}$  bias to  $V_{GAMP}$ ,  $V_{GLNA1}$ ,  $V_{GLNA2}$ ,  $V_{GLNA3}$ ,  $V_{GLNA4}$ ,  $V_{GX2}$ , and  $V_{GX3}$ .
2. Apply a  $-1\text{ V}$  bias to  $V_{GMIX}$ .
3. Apply  $4\text{ V}$  to  $V_{DAMP1}$ ,  $V_{DAMP2}$ ,  $V_{DLNA1}$ ,  $V_{DLNA2}$ ,  $V_{DLNA3}$ , and  $V_{DLNA4}$ , and apply  $1.5\text{ V}$  to  $V_{DMULT}$ .
4. Adjust  $V_{GAMP}$  between  $-2\text{ V}$  and  $0\text{ V}$  to achieve a total amplifier drain current ( $I_{DAMP1} + I_{DAMP2}$ ) of  $175\text{ mA}$ .
5. Adjust  $V_{GLNA1}$ ,  $V_{GLNA2}$ ,  $V_{GLNA3}$ , and  $V_{GLNA4}$  to achieve a total LNA drain current ( $I_{DLNA1} + I_{DLNA2} + I_{DLNA3} + I_{DLNA4}$ ) of  $50\text{ mA}$ .
6. Apply the LO input signal with a power level of  $2\text{ dBm}$  and adjust  $V_{GX2}$  and  $V_{GX3}$  between  $-2\text{ V}$  and  $0\text{ V}$  to achieve  $80\text{ mA}$  of drain current on  $V_{DMULT}$ .

To power down the HMC7587, follow the procedure in reverse.

For additional guidance on general bias sequencing, see the [MMIC Amplifier Biasing Procedure](#) application note.

## IMAGE REJECTION DOWNCONVERSION

A typical image rejection downconversion application circuit is shown in Figure 211. For image rejection downconversions, external  $180^\circ$  and  $90^\circ$  hybrid couplers are typically used. The  $180^\circ$  hybrids or baluns convert the differential I and Q output signals to unbalanced waveforms. The  $90^\circ$  hybrid then combines the outputs in quadrature to form a classic Hartley image rejection receiver with a typical image rejection of  $30\text{ dBc}$ .

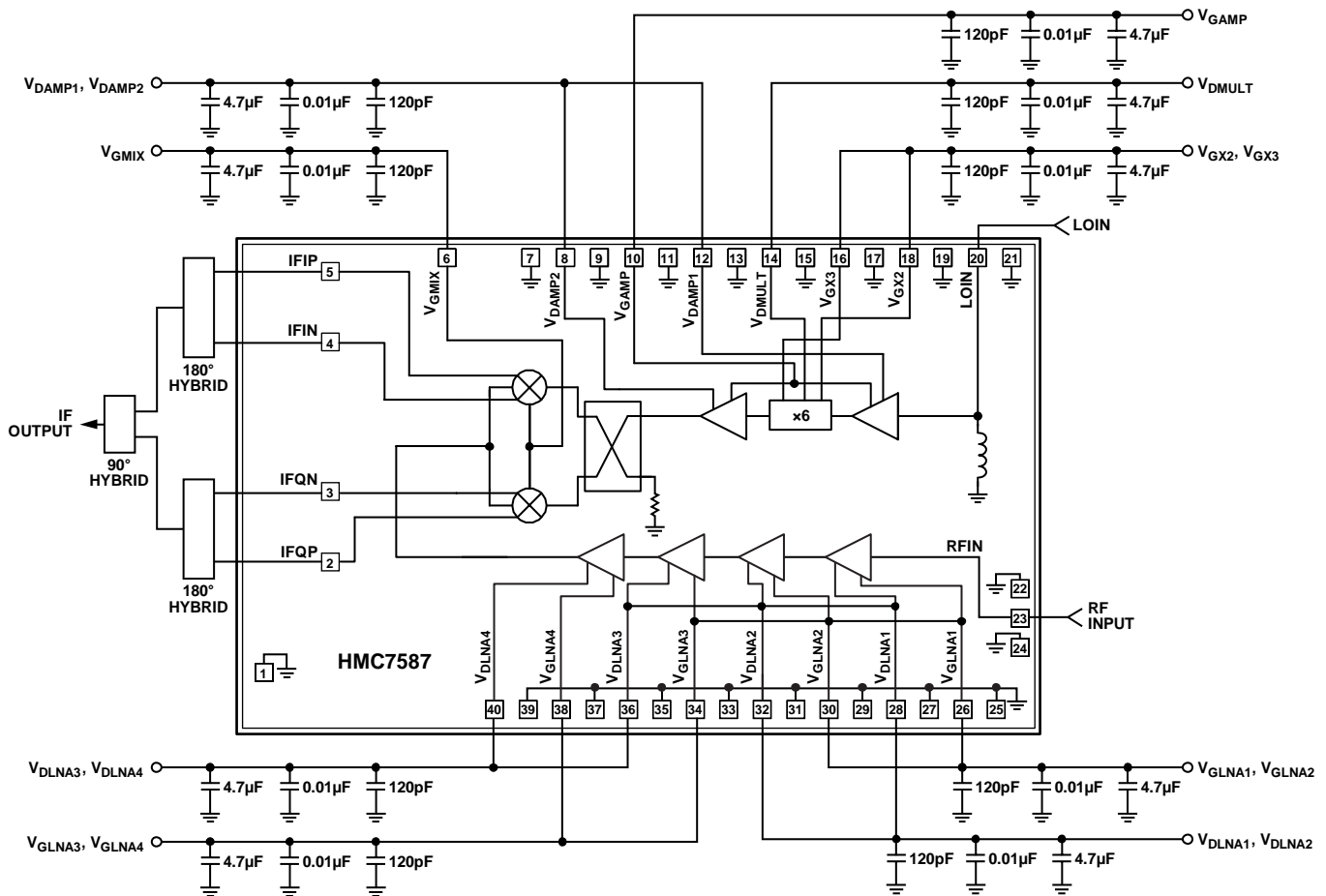

Figure 211. Typical Image Rejection Downconversion Application Circuit

13144-231

**ZERO IF DIRECT CONVERSION**

A typical zero IF direct conversion application circuit is shown in Figure 212. It is important to ac couple the IFIP, IFIN, IFQP, and IFQN pads to the ADC inputs. Most ADCs are designed to operate with a common-mode voltage that is above ground.

The HMC7587 I/Q outputs are ground referenced and dc coupling to a differential signal source with a common-mode output voltage other than 0 V can cause degraded RF performance and possible device damage due to electrical overstress.

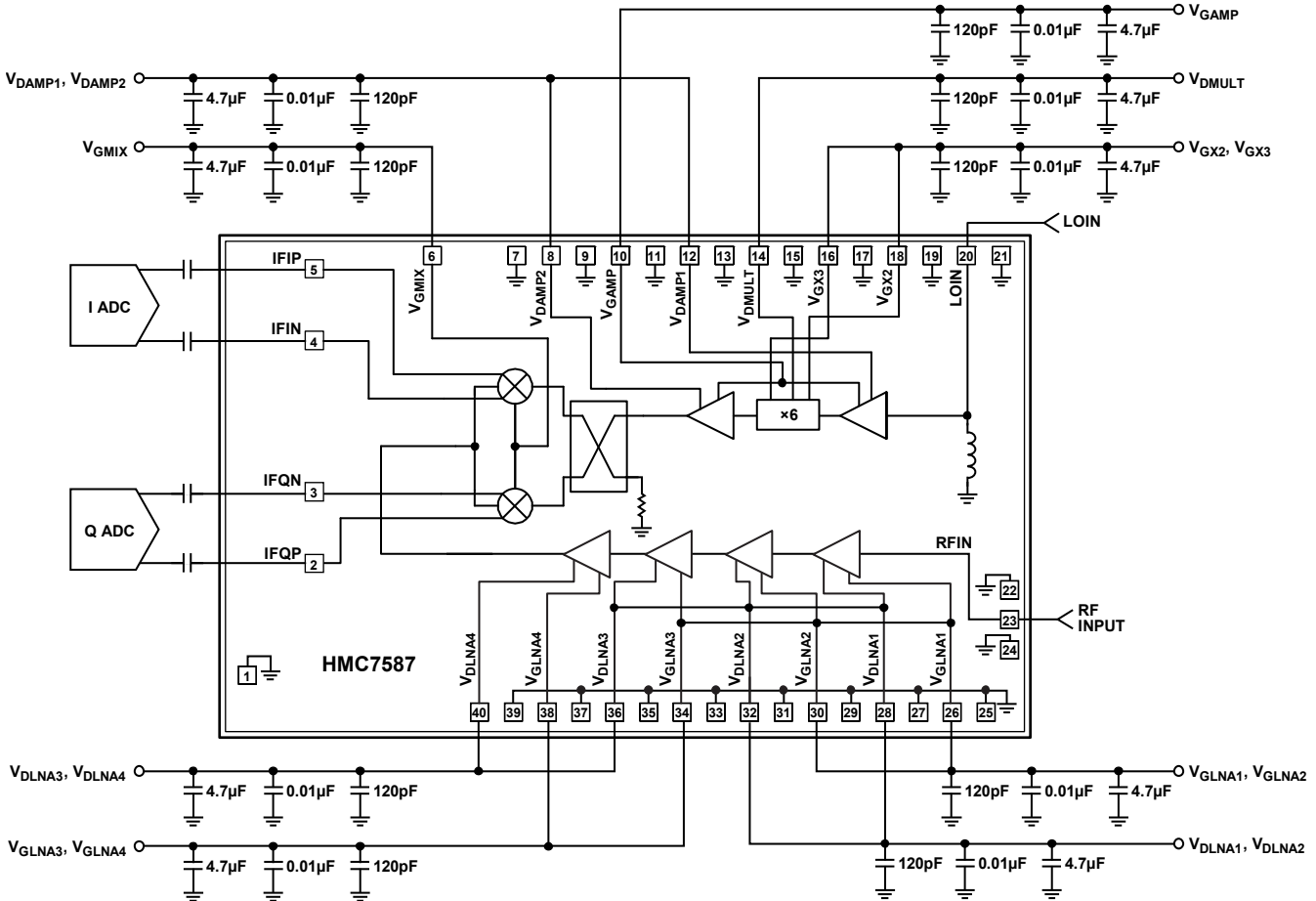

Figure 212. Typical Zero IF Direct Conversion Application Circuit

13141-232

ASSEMBLY DIAGRAM

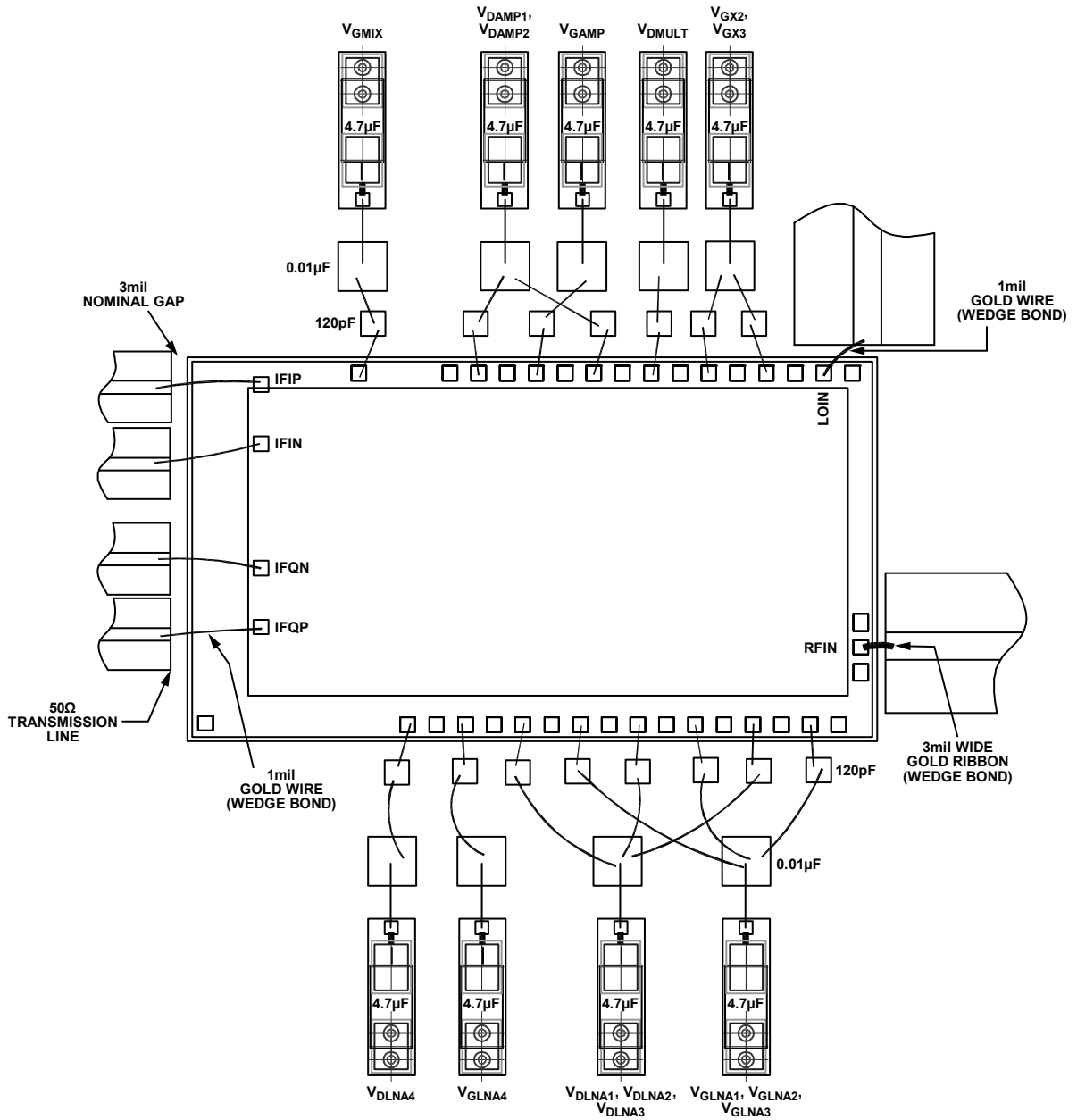

Figure 213. Assembly Diagram

13141-234

## MOUNTING AND BONDING TECHNIQUES FOR MILLIMETERWAVE GaAs MMICS

Attach the die directly to the ground plane eutectically or with conductive epoxy.

To bring RF to and from the chip, use 50  $\Omega$  microstrip transmission lines on 0.127 mm (5 mil) thick alumina thin film substrates (see Figure 214).

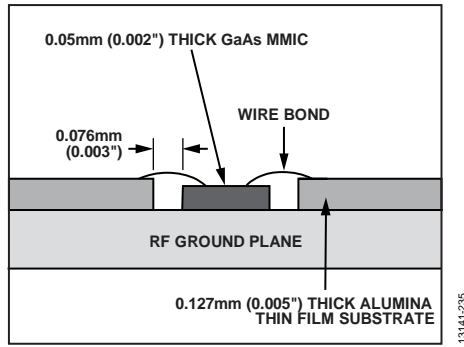

Figure 214. Routing RF Signals

To minimize bond wire length, place microstrip substrates as close to the die as possible. Typical die to substrate spacing is 0.076 mm to 0.152 mm (3 mil to 6 mil).

### HANDLING PRECAUTIONS

To avoid permanent damage, adhere to the following precautions.

#### Storage

All bare die ship in either waffle or gel-based ESD protective containers, sealed in an ESD protective bag. After opening the sealed ESD protective bag, all die must be stored in a dry nitrogen environment.

#### Cleanliness

Handle the chips in a clean environment. Never use liquid cleaning systems to clean the chip.

#### Static Sensitivity

Follow ESD precautions to protect against ESD strikes.

#### Transients

Suppress instrument and bias supply transients while bias is applied. To minimize inductive pickup, use shielded signal and bias cables.

### General Handling

Handle the chip on the edges only using a vacuum collet or with a sharp pair of bent tweezers. Because the surface of the chip has fragile air bridges, never touch the surface of the chip with a vacuum collet, tweezers, or fingers.

### MOUNTING

The chip is back metallized and can be die mounted with gold/tin (AuSn) eutectic preforms or with electrically conductive epoxy. The mounting surface must be clean and flat.

#### Eutectic Die Attach

It is best to use an 80%/20% gold/tin preform with a work surface temperature of 255°C and a tool temperature of 265°C. When hot 90%/10% nitrogen/hydrogen gas is applied, maintain the tool tip temperature at 290°C. Do not expose the chip to a temperature greater than 320°C for more than 20 sec. No more than 3 sec of scrubbing is required for attachment.

#### Epoxy Die Attach

ABLEBOND 84-1LMIT is recommended for die attachment. Apply a minimum amount of epoxy to the mounting surface so that upon placing it into position, a thin epoxy fillet is observed around the perimeter of the chip. Cure epoxy per the schedule provided by the manufacturer.

### WIRE BONDING

RF bonds made with (3 mil (0.0762 mm)  $\times$  0.5 mil (0.0127 mm) gold ribbon are recommended for the RF ports and wedge bonds with 1 mil (0.0254 mm) diameter gold wire are recommended for the IF and LO ports. These bonds must be thermosonically bonded with a force of 40 g to 60 g. DC bonds of 1 mil (0.0254 mm) diameter, thermosonically bonded, are recommended. Create ball bonds with a force of 40 g to 50 g and wedge bonds at 18 g to 22 g. Create all bonds with a nominal stage temperature of 150°C. Apply a minimum amount of ultrasonic energy to achieve reliable bonds. Keep all bonds as possible, less than 12 mils (0.31 mm).

### OUTLINE DIMENSIONS

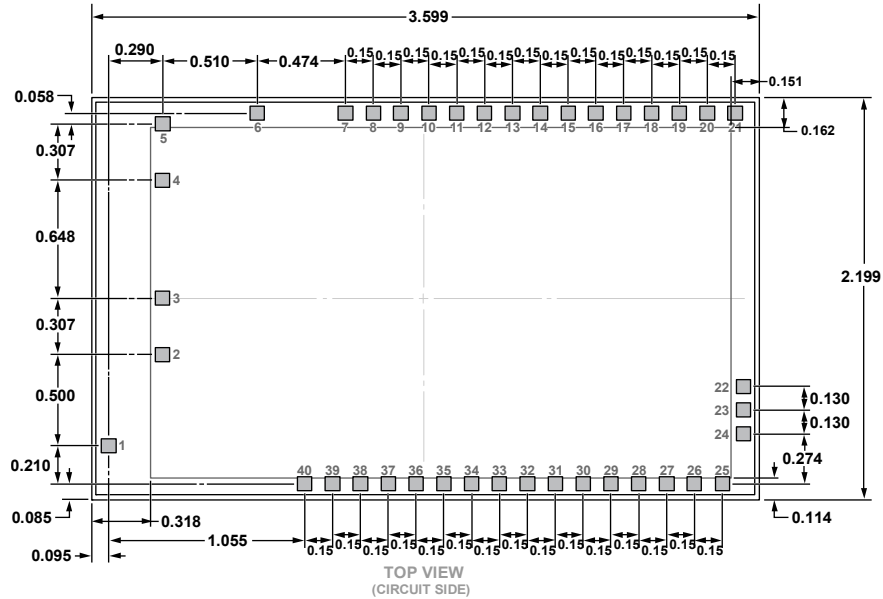

04-10-2015-A

Figure 215. 40-Pad Bare Die [CHIP]  
(C-40-1)  
Dimensions shown in millimeters

### ORDERING GUIDE

Model <sup>1</sup>	Temperature Range	Package Description	Package Option <sup>2</sup>
HMC7587	-55°C to +85°C	40-Pad Bare Die [CHIP]	C-40-1
HMC7587-SX	-55°C to +85°C	40-Pad Bare Die [CHIP]	C-40-1

<sup>1</sup> The HMC7587-SX consists of two pairs of the die in a gel pack for sample orders.

<sup>2</sup> This is a waffle pack option; contact Analog Devices, Inc., for additional packaging options.

## Данный компонент на территории Российской Федерации

### Вы можете приобрести в компании MosChip.

Для оперативного оформления запроса Вам необходимо перейти по данной ссылке:

<http://moschip.ru/get-element>

Вы можете разместить у нас заказ для любого Вашего проекта, будь то серийное производство или разработка единичного прибора.

В нашем ассортименте представлены ведущие мировые производители активных и пассивных электронных компонентов.

Нашей специализацией является поставка электронной компонентной базы двойного назначения, продукции таких производителей как XILINX, Intel (ex.ALTERA), Vicor, Microchip, Texas Instruments, Analog Devices, Mini-Circuits, Amphenol, Glenair.

Сотрудничество с глобальными дистрибьюторами электронных компонентов, предоставляет возможность заказывать и получать с международных складов практически любой перечень компонентов в оптимальные для Вас сроки.

На всех этапах разработки и производства наши партнеры могут получить квалифицированную поддержку опытных инженеров.

Система менеджмента качества компании отвечает требованиям в соответствии с ГОСТ Р ИСО 9001, ГОСТ РВ 0015-002 и ЭС РД 009

### Офис по работе с юридическими лицами:

105318, г.Москва, ул.Щербаковская д.3, офис 1107, 1118, ДЦ «Щербаковский»

Телефон: +7 495 668-12-70 (многоканальный)

Факс: +7 495 668-12-70 (доб.304)

E-mail: [info@moschip.ru](mailto:info@moschip.ru)

Skype отдела продаж:

moschip.ru

moschip.ru\_4

moschip.ru\_6

moschip.ru\_9