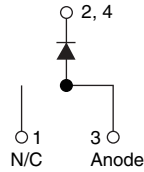

Hyperfast Rectifier, 8 A FRED Pt[®]

D-PAK (TO-252AA)

FEATURES

- Hyperfast recovery time, extremely low Q_{rr}
- 175 °C maximum operating junction temperature
- For PFC CCM operation
- Low forward voltage drop
- Low leakage current
- Meets MSL level 1, per J-STD-020, LF maximum peak of 260 °C
- Material categorization: for definitions of compliance please see www.vishay.com/doc?99912

RoHS
 COMPLIANT
 HALOGEN
FREE

PRODUCT SUMMARY

Package	D-PAK (TO-252AA)
$I_{F(AV)}$	8 A
V_R	600 V
V_F at I_F	3.0 V
t_{rr} (typ.)	15 ns
T_J max.	175 °C
Diode variation	Single die

DESCRIPTION/APPLICATIONS

State of the art hyperfast recovery rectifiers designed with optimized performance of forward voltage drop, hyperfast recovery time, and soft recovery.

The planar structure and the platinum doped life time control guarantee the best overall performance, ruggedness and reliability characteristics.

These devices are intended for use in PFC boost stage in the AC/DC section of SMPS inverters or as freewheeling diodes. Their extremely optimized stored charge and low recovery current minimize the switching losses and reduce over dissipation in the switching element and snubbers.

ABSOLUTE MAXIMUM RATINGS

PARAMETER	SYMBOL	TEST CONDITIONS	VALUES	UNITS
Peak repetitive reverse voltage	V_{RRM}		600	V
Average rectified forward current	$I_{F(AV)}$	$T_C = 140$ °C	8	A
Non-repetitive peak surge current	I_{FSM}	$T_J = 25$ °C	90	
Peak repetitive forward current	I_{FM}	$T_C = 140$ °C, $f = 20$ kHz, $d = 50$ %	16	
Operating junction and storage temperatures	T_J, T_{Stg}		-65 to +175	°C

ELECTRICAL SPECIFICATIONS ($T_J = 25$ °C unless otherwise specified)

PARAMETER	SYMBOL	TEST CONDITIONS	MIN.	TYP.	MAX.	UNITS
Breakdown voltage, blocking voltage	V_{BR}, V_R	$I_R = 100$ μ A	600	-	-	V
Forward voltage	V_F	$I_F = 8$ A	-	2.3	3.0	
		$I_F = 8$ A, $T_J = 150$ °C	-	1.4	1.7	
Reverse leakage current	I_R	$V_R = V_R$ rated	-	-	50	μ A
		$T_J = 150$ °C, $V_R = V_R$ rated	-	-	500	
Junction capacitance	C_T	$V_R = 600$ V	-	7	-	pF
Series inductance	L_S	Measured lead to lead 5 mm from package body	-	8	-	nH



DYNAMIC RECOVERY CHARACTERISTICS ($T_J = 25\text{ }^\circ\text{C}$ unless otherwise specified)						
PARAMETER	SYMBOL	TEST CONDITIONS	MIN.	TYP.	MAX.	UNITS
Reverse recovery time	t_{rr}	$I_F = 1\text{ A}$, $dI_F/dt = 100\text{ A}/\mu\text{s}$, $V_R = 30\text{ V}$	-	15	19	ns
		$T_J = 25\text{ }^\circ\text{C}$	-	17	-	
		$T_J = 125\text{ }^\circ\text{C}$	-	40	-	
Peak recovery current	I_{RRM}	$T_J = 25\text{ }^\circ\text{C}$	-	2.5	-	A
		$T_J = 125\text{ }^\circ\text{C}$	-	4.5	-	
Reverse recovery charge	Q_{rr}	$T_J = 25\text{ }^\circ\text{C}$	-	22	-	nC
		$T_J = 125\text{ }^\circ\text{C}$	-	70	-	

THERMAL - MECHANICAL SPECIFICATIONS						
PARAMETER	SYMBOL	TEST CONDITIONS	MIN.	TYP.	MAX.	UNITS
Maximum junction and storage temperature range	T_J, T_{Stg}		-65	-	+175	$^\circ\text{C}$
Thermal resistance, junction to case per leg	R_{thJC}		-	1.8	2.2	$^\circ\text{C}/\text{W}$
Approximate weight			0.3			g
			0.01			oz.
Marking device		Case style D-PAK (TO-252AA)	8EWX06FN			

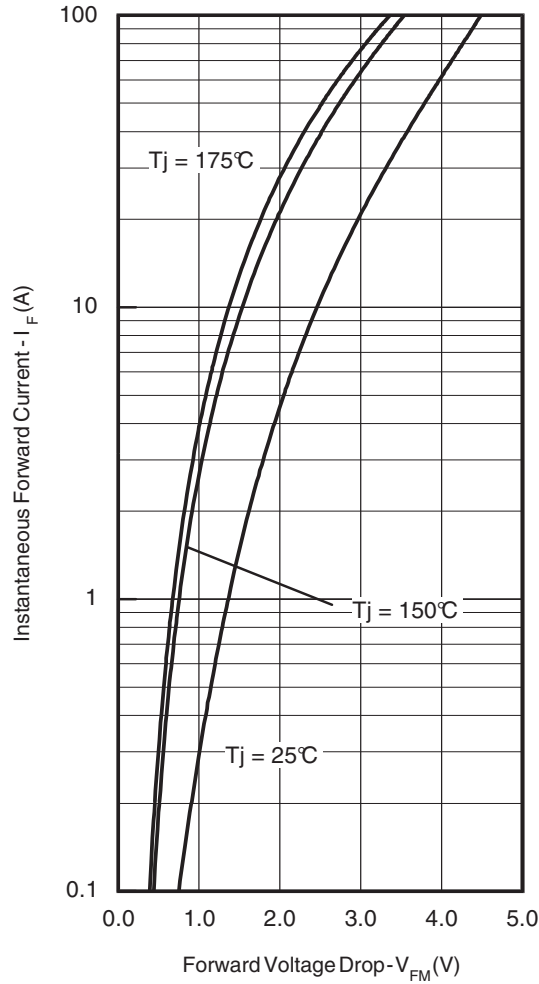

Fig. 1 - Typical Forward Voltage Drop Characteristics

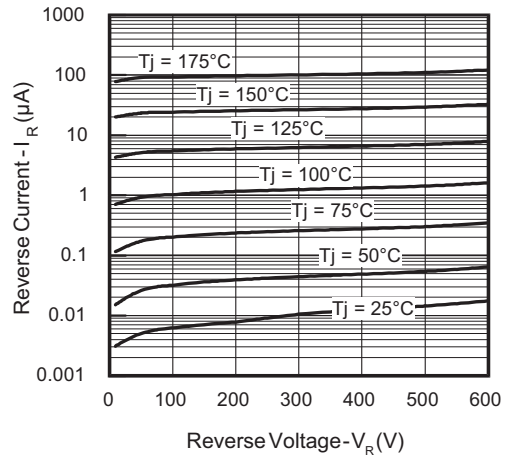

Fig. 2 - Typical Values of Reverse Current vs. Reverse Voltage

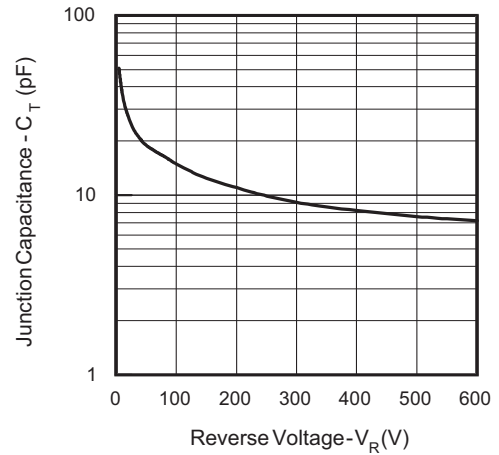

Fig. 3 - Typical Junction Capacitance vs. Reverse Voltage

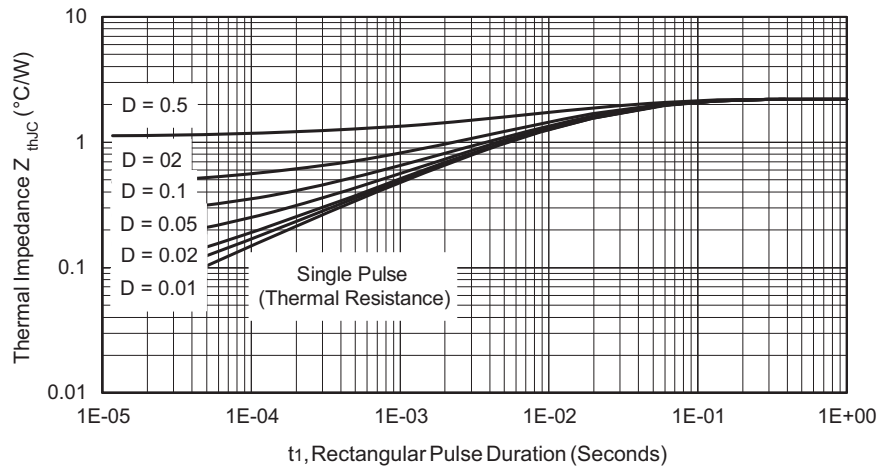

Fig. 4 - Maximum Thermal Impedance Z_{thJC} Characteristics

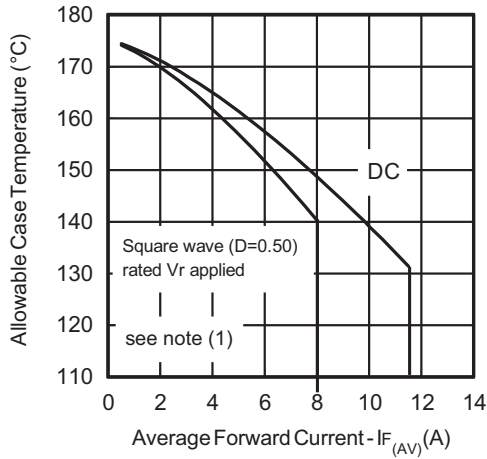

Fig. 5 - Maximum Allowable Case Temperature vs. Average Forward Current

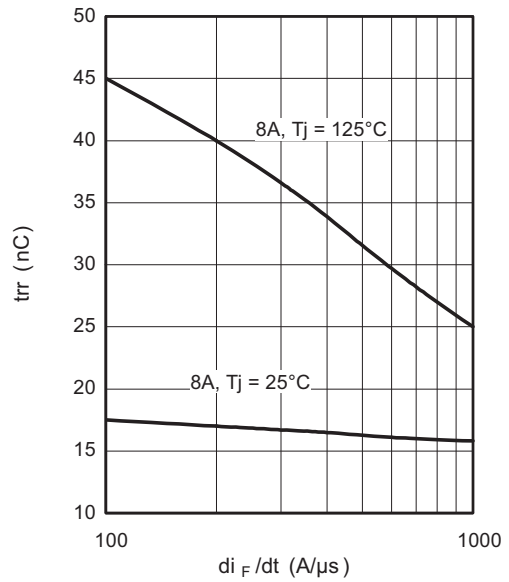

Fig. 7 - Typical Reverse Recovery Time vs. di_F/dt

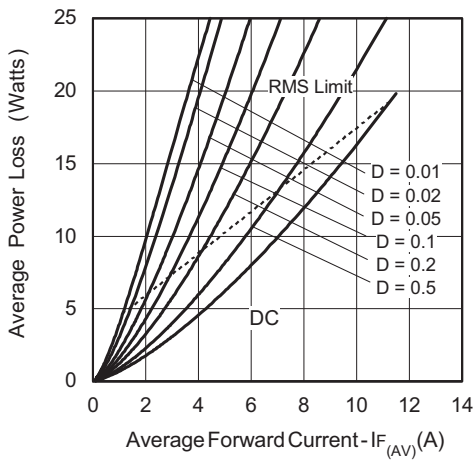

Fig. 6 - Forward Power Loss Characteristics

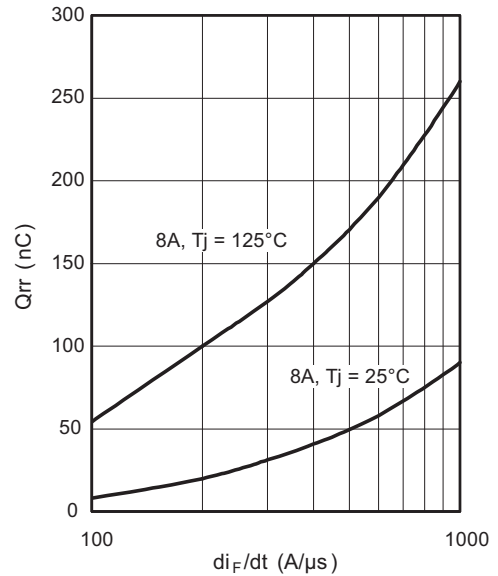

Fig. 8 - Typical Stored Charge vs. di_F/dt

Note

- (1) Formula used: $T_C = T_J - (P_d + P_{d_{REV}}) \times R_{thJC}$;
 P_d = Forward power loss = $I_{F(AV)} \times V_{FM}$ at $(I_{F(AV)}/D)$ (see fig. 6);
 $P_{d_{REV}}$ = Inverse power loss = $V_{R1} \times I_R (1 - D)$; I_R at V_{R1} = Rated V_R

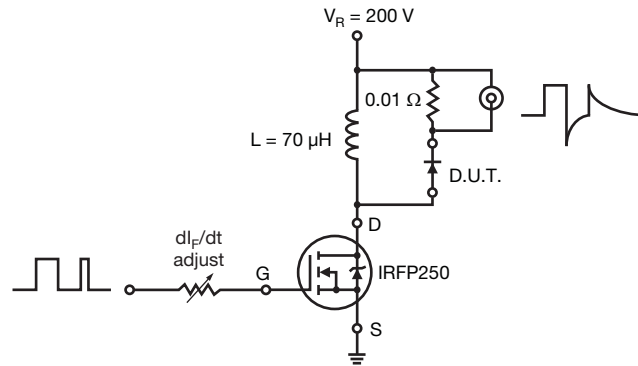
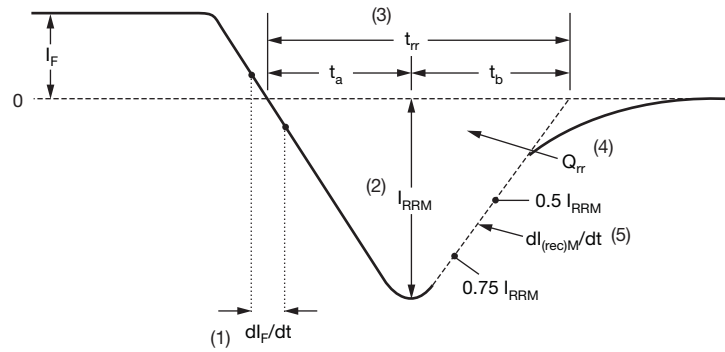

Fig. 9 - Reverse Recovery Parameter Test Circuit



- (1) di_F/dt - rate of change of current through zero crossing
- (2) I_{RRM} - peak reverse recovery current
- (3) t_{rr} - reverse recovery time measured from zero crossing point of negative going I_F to point where a line passing through $0.75 I_{RRM}$ and $0.50 I_{RRM}$ extrapolated to zero current.
- (4) Q_{rr} - area under curve defined by t_{rr} and I_{RRM}
- (5) $dl_{(rec)M}/dt$ - peak rate of change of current during t_b portion of t_{rr}

$$Q_{rr} = \frac{t_{rr} \times I_{RRM}}{2}$$

Fig. 10 - Reverse Recovery Waveform and Definitions



ORDERING INFORMATION TABLE

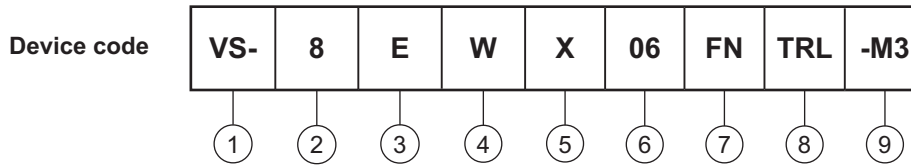

- 1** - Vishay Semiconductors product
- 2** - Current rating (8 = 8 A)
- 3** - Circuit configuration:
E = Single diode
- 4** - Package identifier:
W = D-PAK
- 5** - X = Hyperfast recovery time
- 6** - Voltage rating (06 = 600 V)
- 7** - FN = TO-252AA
- 8** -
 - None = Tube
 - TR = Tape and reel
 - TRL = Tape and reel (left oriented)
 - TRR = Tape and reel (right oriented)
- 9** - Environmental digit:
-M3 = Halogen-free, RoHS compliant and terminations lead (Pb)-free

ORDERING INFORMATION (Example)			
PREFERRED P/N	QUANTITY PER T/R	MINIMUM ORDER QUANTITY	PACKAGING DESCRIPTION
VS-8EWX06FN-M3	75	3000	Antistatic plastic tube
VS-8EWX06FNTR-M3	2000	2000	13" diameter reel
VS-8EWX06FNTRL-M3	3000	3000	13" diameter reel
VS-8EWX06FNTRR-M3	3000	3000	13" diameter reel

LINKS TO RELATED DOCUMENTS	
Dimensions	www.vishay.com/doc?95016
Part marking information	www.vishay.com/doc?95176
Packaging information	www.vishay.com/doc?95033
SPICE model	www.vishay.com/doc?95374

D-PAK (TO-252AA)

DIMENSIONS in millimeters and inches



SYMBOL	MILLIMETERS		INCHES		NOTES	SYMBOL	MILLIMETERS		INCHES		NOTES
	MIN.	MAX.	MIN.	MAX.			MIN.	MAX.	MIN.	MAX.	
A	2.18	2.39	0.086	0.094		e	2.29 BSC		0.090 BSC		
A1	-	0.13	-	0.005		H	9.40	10.41	0.370	0.410	
b	0.64	0.89	0.025	0.035		L	1.40	1.78	0.055	0.070	
b2	0.76	1.14	0.030	0.045		L1	2.74 BSC		0.108 REF.		
b3	4.95	5.46	0.195	0.215	3	L2	0.51 BSC		0.020 BSC		
c	0.46	0.61	0.018	0.024		L3	0.89	1.27	0.035	0.050	3
c2	0.46	0.89	0.018	0.035		L4	-	1.02	-	0.040	
D	5.97	6.22	0.235	0.245	5	L5	1.14	1.52	0.045	0.060	2
D1	5.21	-	0.205	-	3	Ø	0°	10°	0°	10°	
E	6.35	6.73	0.250	0.265	5	Ø1	0°	15°	0°	15°	
E1	4.32	-	0.170	-	3	Ø2	25°	35°	25°	35°	

Notes

- (1) Dimensioning and tolerancing as per ASME Y14.5M-1994
- (2) Lead dimension uncontrolled in L5
- (3) Dimension D1, E1, L3 and b3 establish a minimum mounting surface for thermal pad
- (4) Section C - C dimension apply to the flat section of the lead between 0.13 and 0.25 mm (0.005 and 0.10") from the lead tip
- (5) Dimension D, and E do not include mold flash. Mold flash shall not exceed 0.127 mm (0.005") per side. These dimensions are measured at the outermost extremes of the plastic body
- (6) Dimension b1 and c1 applied to base metal only
- (7) Datum A and B to be determined at datum plane H
- (8) Outline conforms to JEDEC outline TO-252AA



Disclaimer

ALL PRODUCT, PRODUCT SPECIFICATIONS AND DATA ARE SUBJECT TO CHANGE WITHOUT NOTICE TO IMPROVE RELIABILITY, FUNCTION OR DESIGN OR OTHERWISE.

Vishay Intertechnology, Inc., its affiliates, agents, and employees, and all persons acting on its or their behalf (collectively, "Vishay"), disclaim any and all liability for any errors, inaccuracies or incompleteness contained in any datasheet or in any other disclosure relating to any product.

Vishay makes no warranty, representation or guarantee regarding the suitability of the products for any particular purpose or the continuing production of any product. To the maximum extent permitted by applicable law, Vishay disclaims (i) any and all liability arising out of the application or use of any product, (ii) any and all liability, including without limitation special, consequential or incidental damages, and (iii) any and all implied warranties, including warranties of fitness for particular purpose, non-infringement and merchantability.

Statements regarding the suitability of products for certain types of applications are based on Vishay's knowledge of typical requirements that are often placed on Vishay products in generic applications. Such statements are not binding statements about the suitability of products for a particular application. It is the customer's responsibility to validate that a particular product with the properties described in the product specification is suitable for use in a particular application. Parameters provided in datasheets and/or specifications may vary in different applications and performance may vary over time. All operating parameters, including typical parameters, must be validated for each customer application by the customer's technical experts. Product specifications do not expand or otherwise modify Vishay's terms and conditions of purchase, including but not limited to the warranty expressed therein.

Except as expressly indicated in writing, Vishay products are not designed for use in medical, life-saving, or life-sustaining applications or for any other application in which the failure of the Vishay product could result in personal injury or death. Customers using or selling Vishay products not expressly indicated for use in such applications do so at their own risk. Please contact authorized Vishay personnel to obtain written terms and conditions regarding products designed for such applications.

No license, express or implied, by estoppel or otherwise, to any intellectual property rights is granted by this document or by any conduct of Vishay. Product names and markings noted herein may be trademarks of their respective owners.

Material Category Policy

Vishay Intertechnology, Inc. hereby certifies that all its products that are identified as RoHS-Compliant fulfill the definitions and restrictions defined under Directive 2011/65/EU of The European Parliament and of the Council of June 8, 2011 on the restriction of the use of certain hazardous substances in electrical and electronic equipment (EEE) - recast, unless otherwise specified as non-compliant.

Please note that some Vishay documentation may still make reference to RoHS Directive 2002/95/EC. We confirm that all the products identified as being compliant to Directive 2002/95/EC conform to Directive 2011/65/EU.

Vishay Intertechnology, Inc. hereby certifies that all its products that are identified as Halogen-Free follow Halogen-Free requirements as per JEDEC JS709A standards. Please note that some Vishay documentation may still make reference to the IEC 61249-2-21 definition. We confirm that all the products identified as being compliant to IEC 61249-2-21 conform to JEDEC JS709A standards.

Данный компонент на территории Российской Федерации

Вы можете приобрести в компании MosChip.

Для оперативного оформления запроса Вам необходимо перейти по данной ссылке:

<http://moschip.ru/get-element>

Вы можете разместить у нас заказ для любого Вашего проекта, будь то серийное производство или разработка единичного прибора.

В нашем ассортименте представлены ведущие мировые производители активных и пассивных электронных компонентов.

Нашей специализацией является поставка электронной компонентной базы двойного назначения, продукции таких производителей как XILINX, Intel (ex.ALTERA), Vicor, Microchip, Texas Instruments, Analog Devices, Mini-Circuits, Amphenol, Glenair.

Сотрудничество с глобальными дистрибьюторами электронных компонентов, предоставляет возможность заказывать и получать с международных складов практически любой перечень компонентов в оптимальные для Вас сроки.

На всех этапах разработки и производства наши партнеры могут получить квалифицированную поддержку опытных инженеров.

Система менеджмента качества компании отвечает требованиям в соответствии с ГОСТ Р ИСО 9001, ГОСТ РВ 0015-002 и ЭС РД 009

Офис по работе с юридическими лицами:

105318, г.Москва, ул.Щербаковская д.3, офис 1107, 1118, ДЦ «Щербаковский»

Телефон: +7 495 668-12-70 (многоканальный)

Факс: +7 495 668-12-70 (доб.304)

E-mail: info@moschip.ru

Skype отдела продаж:

moschip.ru

moschip.ru_4

moschip.ru_6

moschip.ru_9