

Model 345

HFF LVPECL VCXO

Features

- Ceramic Surface Mount Package
- Ultra-Low Phase Jitter Performance
- High Frequency Fundamental Crystal Design
- Frequency Range 100 – 250MHz *
- +3.3V Operation
- Output Enable Standard
- Tape and Reel Packaging, EIA-418



Part Dimensions:
5.0 × 3.2 × 1.2mm • 62.28mg

Applications

- Small Cells
- Wireless Communication
- Broadband Access
- SONET/SDH/DWDM
- Base Stations
- Ethernet/GbE/SyncE
- Digital Video
- Test and Measurement

Standard Frequencies	
- 100.00MHz	- 156.25MHz
- 122.88MHz	- 166.00MHz
- 125.00MHz	- 200.00MHz
- 153.60MHz	- 204.80MHz
- 155.52MHz	- 245.76MHz *

* Check with factory for availability.

Description

CTS Model 345 is a low cost, small size, high performance VCXO. Employing the latest IC technology, coupled with a high frequency fundamental crystal, M345 has excellent stability and low jitter/phase noise performance.

Ordering Information

Model	Supply Voltage	Absolute Pull Range	Frequency Stability	Temperature Range	Frequency Code [MHz]	Packaging
345	L	B	3	I	XXX or XXXX	T
	Code Voltage		Code Stability		Code Frequency	
	L +3.3V ±5%		3 ±50ppm 5 ±25ppm 6 ±20ppm ¹		Product Frequency Code ²	
		Code APR		Code Temp. Range		Code Packing
		B ±50ppm ³		C -20°C to +70°C I -40°C to +85°C		T 1k pcs./reel

Notes:

- 1] Only available with "C" temperature range.
- 2] Refer to document 016-1454-0, Frequency Code Tables.
3-digits for frequencies <100MHz, 4-digits for frequencies 100MHz or greater.
- 3] Frequencies ≥200MHz, APR is ±30ppm.

**Not all performance combinations and frequencies may be available.
Contact your local CTS Representative or CTS Customer Service for availability.**



Electrical Specifications

Operating Conditions

PARAMETER	SYMBOL	CONDITIONS	MIN	TYP	MAX	UNIT
Maximum Supply Voltage	V _{CC}	-	-0.3	-	5.0	V
Maximum Control Voltage	V _C	-	-0.5	-	V _{CC}	V
Supply Voltage	V _{CC}	±5%	3.14	3.3	3.47	V
Supply Current	I _{CC}	Typical @ LVPECL Load, T _A = +25°C	-	65	80	mA
Output Load	R _L	Terminated to V _{CC} - 2.0V	-	50	-	Ohms
Operating Temperature	T _A	-	-20 -40	+25	+70 +85	°C
Storage Temperature	T _{STG}	-	-40	-	+100	°C

Frequency Stability

PARAMETER	SYMBOL	CONDITIONS	MIN	TYP	MAX	UNIT
Frequency Range	f ₀	-		100 - 250		MHz
Frequency Stability [Note 1]	Δf/f ₀	±20ppm stability, -20°C to +70°C only		20, 25 or 50		±ppm
Absolute Pull Range [Note 2]	APR	Frequencies ≥200MHz, APR is ±30ppm	50	-	-	±ppm
Aging	Δf/f ₂₅	First Year @ +25°C, nominal V _{CC} and V _C	-3	-	3	ppm

1.] Inclusive of initial tolerance at time of shipment, changes in supply voltage, load, temperature and 1st year aging.

2.] Minimum guaranteed frequency shift from f₀ over variations in temperature, aging, power supply and load.

Output Parameters

PARAMETER	SYMBOL	CONDITIONS	MIN	TYP	MAX	UNIT
Output Type	-	-		LVPECL		-
Output Voltage Levels	V _{OH} V _{OL}	LVPECL Load, -40°C to +85°C LVPECL Load, -40°C to +85°C	V _{CC} - 1.085 V _{CC} - 1.810	- -	V _{CC} - 0.880 V _{CC} - 1.620	V
Output Duty Cycle	SYM	@ V _{CC} - 1.3V	45	-	55	%
Rise and Fall Time	T _R , T _F	@ 20%/80% Levels	-	0.3	1.0	ns
Start Up Time	T _S	Application of V _{CC}	-	5	10	ms
Enable Function						
Enable Input Voltage	V _{IH}	Pin 2 Logic '1', Output Enabled	0.7V _{CC}	-	-	V
Disable Input Voltage	V _{IL}	Pin 2 Logic '0', Output Disabled	-	-	0.3V _{CC}	V
Standby Current	I _{STB}	Pin 2 Logic '0', Output Standby	-	-	10	μA
Enable Time	T _{PLZ}	Pin 2 Logic '1'	-	-	20	μs
Phase Jitter, RMS	t _{jrms}	Bandwidth 12 kHz - 20 MHz	-	90	500	fs
Phase Noise	-	See Typical Plots	-	-	-	-

Enable Truth Table

Pin 2	Pin 4 & 5
Logic '1'	Output
Open	Output
Logic '0'	High Imp.

Electrical Specifications

Control Voltage

PARAMETER	SYMBOL	CONDITIONS	MIN	TYP	MAX	UNIT
Control Voltage	V_C	-	0.30	1.65	3.00	V
Frequency Deviation	$\Delta f/f_0$	$V_C = 0.0V$		-155 to -75		ppm
		$V_C = 3.3V$		75 to 155		
Linearity	L	Best Straight Line Fit	-	5	10	%
Gain Transfer	K_V	Pull Sensitivity; @ +1.65V, +25°C	-	75	-	ppm/V
Input Impedance	Z_{Vc}	-	10	-	-	MOhms
Modulation Roll-off	-	@ -3dB	25	-	-	kHz
Transfer Function	-	-		Positive		-

Test Circuit

LVPECL

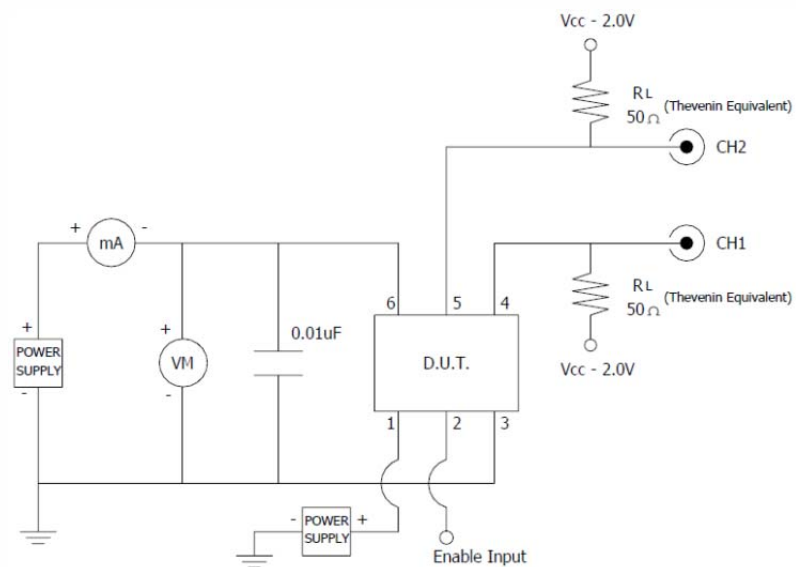

Output Waveform

LVPECL

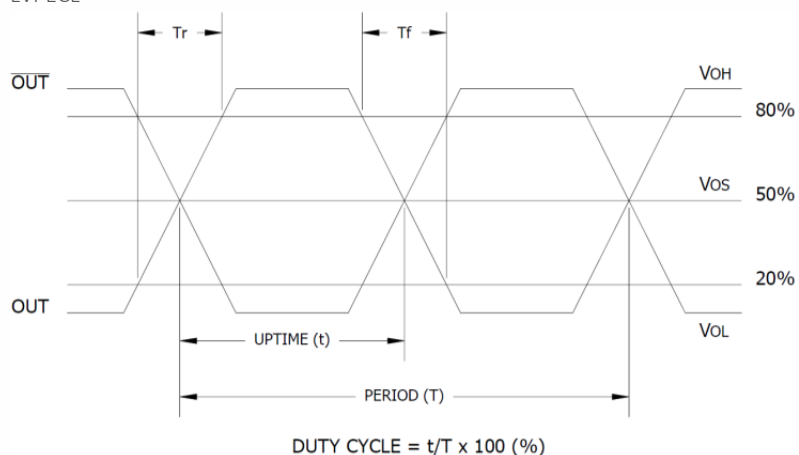

Electrical Specifications

Performance Data

Frequency Deviation – Over Temperature [typical]

122.88MHz, $V_{CC} = 3.3V$, $V_C = 1.65V$

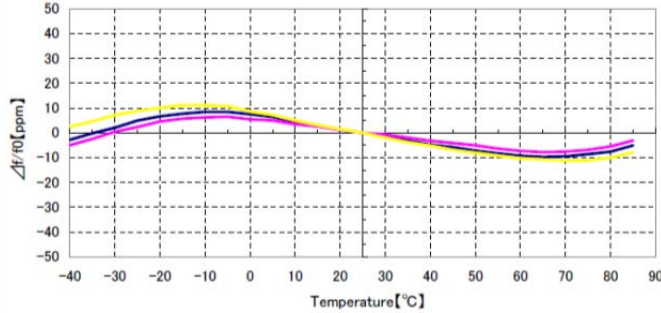

156.25MHz, $V_{CC} = 3.3V$, $V_C = 1.65V$

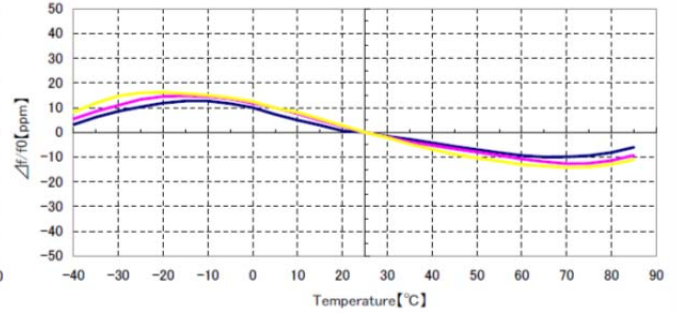

Frequency Deviation – Pulling Range [typical]

122.88MHz, $V_{CC} = 3.3V$, $T_A = +25^\circ V$

Pulling range

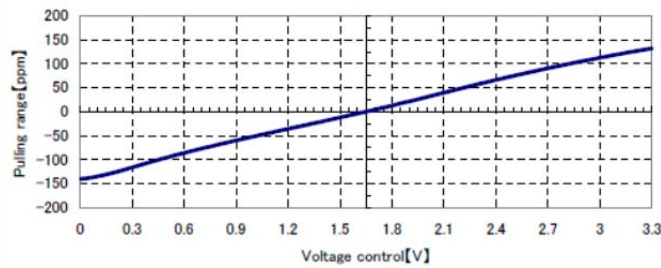

156.25MHz, $V_{CC} = 3.3V$, $T_A = +25^\circ V$

Pulling range

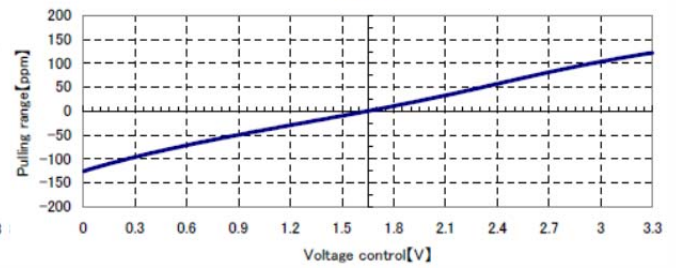

Frequency Deviation – Gain Transfer [typical]

122.88MHz, $V_{CC} = 3.3V$, $T_A = +25^\circ V$

Sensitivity

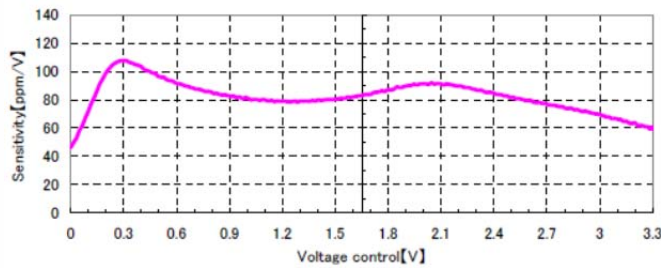

156.25MHz, $V_{CC} = 3.3V$, $T_A = +25^\circ V$

Sensitivity

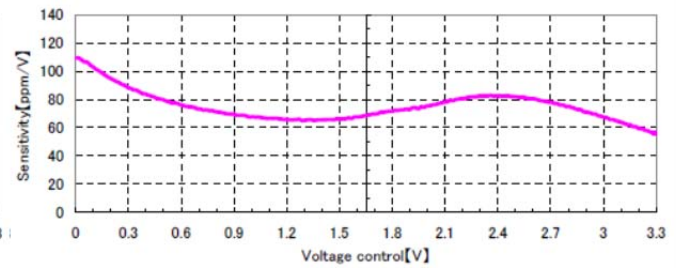



Electrical Specifications

Performance Data

Phase Noise [typical]

122.88MHz, $V_{CC} = 3.3V$, $V_C = 1.65V$, $T_A = +25^\circ C$



156.25MHz, $V_{CC} = 3.3V$, $V_C = 1.65V$, $T_A = +25^\circ C$



Mechanical Specifications

Package Drawing



Marking Information

- ** - Manufacturing Site Code.
- D - Date Code. See Table I for codes.
- ST - Frequency Stability/Temperature Code. [Refer to Ordering Information]
- V - Voltage Code. L = 3.3V
- xxxx - Frequency Code. 4-digits required for frequencies 100MHz and above. [See document 016-1454-0, Frequency Code Tables.]

Recommended Pad Layout



Notes

- Termination pads (e4). Barrier-plating is nickel [Ni] with gold [Au] flash plate.
- Reflow conditions per JEDEC J-STD-020; +260°C maximum, 20 seconds.
- MSL = 1.

Pin Assignments

Pin	Symbol	Function
1	V _C	Control Voltage
2	EOH	Enable
3	GND	Circuit & Package
4	Output	RF Output
5	Output	RF Output, Complementary
6	V _{CC}	Supply Voltage

Table I - Date Code

YEAR		MONTH					JAN	FEB	MAR	APR	MAY	JUN	JUL	AUG	SEP	OCT	NOV	DEC
2001	2005	2009	2013	2017		A	B	C	D	E	F	G	H	J	K	L	M	
2002	2006	2010	2014	2018		N	P	Q	R	S	T	U	V	W	X	Y	Z	
2003	2007	2011	2015	2019		a	b	c	d	e	f	g	h	j	k	l	m	
2004	2008	2012	2016	2020		n	p	q	r	s	t	u	v	w	x	y	z	

Packaging - Tape and Reel

Tape Drawing



Reel Drawing



Notes

1. Device quantity is 1k pieces maximum per 180mm reel.
2. Complete CTS part number, frequency value and date code information must appear on reel and carton labels.

Данный компонент на территории Российской Федерации

Вы можете приобрести в компании MosChip.

Для оперативного оформления запроса Вам необходимо перейти по данной ссылке:

<http://moschip.ru/get-element>

Вы можете разместить у нас заказ для любого Вашего проекта, будь то серийное производство или разработка единичного прибора.

В нашем ассортименте представлены ведущие мировые производители активных и пассивных электронных компонентов.

Нашей специализацией является поставка электронной компонентной базы двойного назначения, продукции таких производителей как XILINX, Intel (ex.ALTERA), Vicor, Microchip, Texas Instruments, Analog Devices, Mini-Circuits, Amphenol, Glenair.

Сотрудничество с глобальными дистрибьюторами электронных компонентов, предоставляет возможность заказывать и получать с международных складов практически любой перечень компонентов в оптимальные для Вас сроки.

На всех этапах разработки и производства наши партнеры могут получить квалифицированную поддержку опытных инженеров.

Система менеджмента качества компании отвечает требованиям в соответствии с ГОСТ Р ИСО 9001, ГОСТ РВ 0015-002 и ЭС РД 009

Офис по работе с юридическими лицами:

105318, г.Москва, ул.Щербаковская д.3, офис 1107, 1118, ДЦ «Щербаковский»

Телефон: +7 495 668-12-70 (многоканальный)

Факс: +7 495 668-12-70 (доб.304)

E-mail: info@moschip.ru

Skype отдела продаж:

moschip.ru

moschip.ru_4

moschip.ru_6

moschip.ru_9