

# Model 345

## HFF LVPECL VCXO

### Features

- Ceramic Surface Mount Package
- Ultra-Low Phase Jitter Performance
- High Frequency Fundamental Crystal Design
- Frequency Range 100 – 250MHz \*
- +3.3V Operation
- Output Enable Standard
- Tape and Reel Packaging, EIA-418

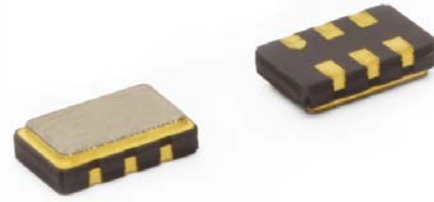

Part Dimensions:  
5.0 × 3.2 × 1.2mm • 62.28mg

### Applications

- Small Cells
- Wireless Communication
- Broadband Access
- SONET/SDH/DWDM
- Base Stations
- Ethernet/GbE/SyncE
- Digital Video
- Test and Measurement

Standard Frequencies	
- 100.00MHz	- 156.25MHz
- 122.88MHz	- 166.00MHz
- 125.00MHz	- 200.00MHz
- 153.60MHz	- 204.80MHz
- 155.52MHz	- 245.76MHz *

\* Check with factory for availability.

### Description

CTS Model 345 is a low cost, small size, high performance VCXO. Employing the latest IC technology, coupled with a high frequency fundamental crystal, M345 has excellent stability and low jitter/phase noise performance.

### Ordering Information

Model	Supply Voltage	Absolute Pull Range	Frequency Stability	Temperature Range	Frequency Code [MHz]	Packaging
345	L	B	3	I	XXX or XXXX	T
	Code Voltage L +3.3V ±5%		Code Stability 3 ±50ppm 5 ±25ppm 6 ±20ppm <sup>1</sup>		Code Frequency Product Frequency Code <sup>2</sup>	
		Code APR B ±50ppm <sup>3</sup>		Code Temp. Range C -20°C to +70°C I -40°C to +85°C		Code Packing T 1k pcs./reel

Notes:

- 1] Only available with "C" temperature range.
- 2] Refer to document 016-1454-0, Frequency Code Tables.  
3-digits for frequencies <100MHz, 4-digits for frequencies 100MHz or greater.
- 3] Frequencies ≥200MHz, APR is ±30ppm.

**Not all performance combinations and frequencies may be available.  
Contact your local CTS Representative or CTS Customer Service for availability.**

## Electrical Specifications

### Operating Conditions

PARAMETER	SYMBOL	CONDITIONS	MIN	TYP	MAX	UNIT
Maximum Supply Voltage	$V_{CC}$	-	-0.3	-	5.0	V
Maximum Control Voltage	$V_C$	-	-0.5	-	$V_{CC}$	V
Supply Voltage	$V_{CC}$	$\pm 5\%$	3.14	3.3	3.47	V
Supply Current	$I_{CC}$	Typical @ LVPECL Load, $T_A = +25^\circ\text{C}$	-	65	80	mA
Output Load	$R_L$	Terminated to $V_{CC} - 2.0\text{V}$	-	50	-	Ohms
Operating Temperature	$T_A$	-	-20 -40	+25	+70 +85	$^\circ\text{C}$
Storage Temperature	$T_{STG}$	-	-40	-	+100	$^\circ\text{C}$

### Frequency Stability

PARAMETER	SYMBOL	CONDITIONS	MIN	TYP	MAX	UNIT
Frequency Range	$f_0$	-		100 - 250		MHz
Frequency Stability [Note 1]	$\Delta f/f_0$	$\pm 20\text{ppm}$ stability, $-20^\circ\text{C}$ to $+70^\circ\text{C}$ only		20, 25 or 50		$\pm\text{ppm}$
Absolute Pull Range [Note 2]	APR	Frequencies $\geq 200\text{MHz}$ , APR is $\pm 30\text{ppm}$	50	-	-	$\pm\text{ppm}$
Aging	$\Delta f/f_{25}$	First Year @ $+25^\circ\text{C}$ , nominal $V_{CC}$ and $V_C$	-3	-	3	ppm

1.] Inclusive of initial tolerance at time of shipment, changes in supply voltage, load, temperature and 1st year aging.

2.] Minimum guaranteed frequency shift from  $f_0$  over variations in temperature, aging, power supply and load.

### Output Parameters

PARAMETER	SYMBOL	CONDITIONS	MIN	TYP	MAX	UNIT
Output Type	-	-		LVPECL		-
Output Voltage Levels	$V_{OH}$ $V_{OL}$	LVPECL Load, $-40^\circ\text{C}$ to $+85^\circ\text{C}$ LVPECL Load, $-40^\circ\text{C}$ to $+85^\circ\text{C}$	$V_{CC} - 1.085$ $V_{CC} - 1.810$	- -	$V_{CC} - 0.880$ $V_{CC} - 1.620$	V
Output Duty Cycle	SYM	@ $V_{CC} - 1.3\text{V}$	45	-	55	%
Rise and Fall Time	$T_R, T_F$	@ 20%/80% Levels	-	0.3	1.0	ns
Start Up Time	$T_S$	Application of $V_{CC}$	-	5	10	ms
<b>Enable Function</b>						
Enable Input Voltage	$V_{IH}$	Pin 2 Logic '1', Output Enabled	$0.7V_{CC}$	-	-	V
Disable Input Voltage	$V_{IL}$	Pin 2 Logic '0', Output Disabled	-	-	$0.3V_{CC}$	V
Standby Current	$I_{STB}$	Pin 2 Logic '0', Output Standby	-	-	10	$\mu\text{A}$
Enable Time	$T_{PLZ}$	Pin 2 Logic '1'	-	-	20	$\mu\text{s}$
Phase Jitter, RMS	$t_{jrms}$	Bandwidth 12 kHz - 20 MHz	-	90	500	fs
Phase Noise	-	See Typical Plots	-	-	-	-

### Enable Truth Table

Pin 2	Pin 4 & 5
Logic '1'	Output
Open	Output
Logic '0'	High Imp.

## Electrical Specifications

### Control Voltage

PARAMETER	SYMBOL	CONDITIONS	MIN	TYP	MAX	UNIT
Control Voltage	$V_C$	-	0.30	1.65	3.00	V
Frequency Deviation	$\Delta f/f_0$	$V_C = 0.0V$		-155 to -75		ppm
		$V_C = 3.3V$		75 to 155		
Linearity	L	Best Straight Line Fit	-	5	10	%
Gain Transfer	$K_V$	Pull Sensitivity; @ +1.65V, +25°C	-	75	-	ppm/V
Input Impedance	$Z_{Vc}$	-	10	-	-	MOhms
Modulation Roll-off	-	@ -3dB	25	-	-	kHz
Transfer Function	-	-		Positive		-

### Test Circuit

LVPECL

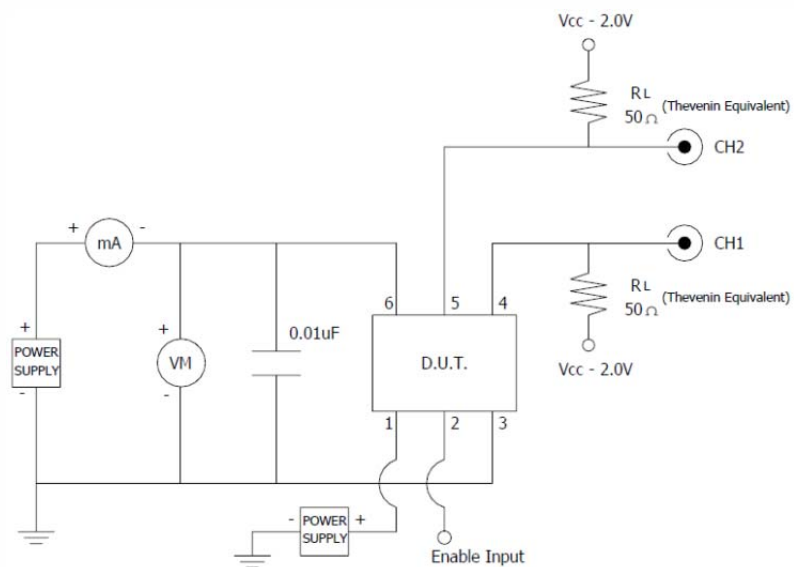

### Output Waveform

LVPECL

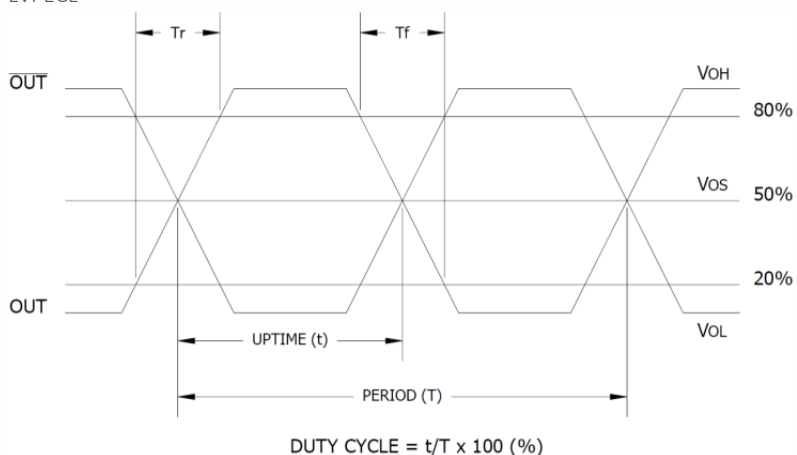

## Electrical Specifications

### Performance Data

#### Frequency Deviation – Over Temperature [typical]

122.88MHz,  $V_{CC} = 3.3V$ ,  $V_C = 1.65V$



156.25MHz,  $V_{CC} = 3.3V$ ,  $V_C = 1.65V$

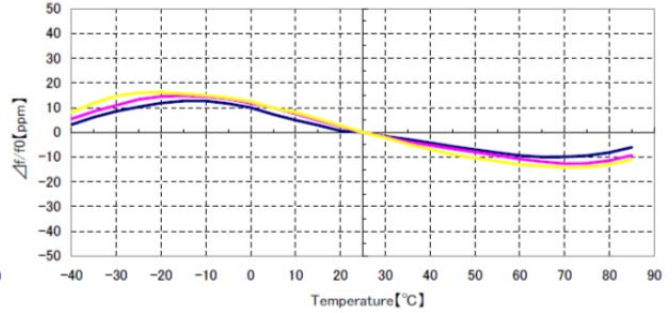

#### Frequency Deviation – Pulling Range [typical]

122.88MHz,  $V_{CC} = 3.3V$ ,  $T_A = +25^\circ V$

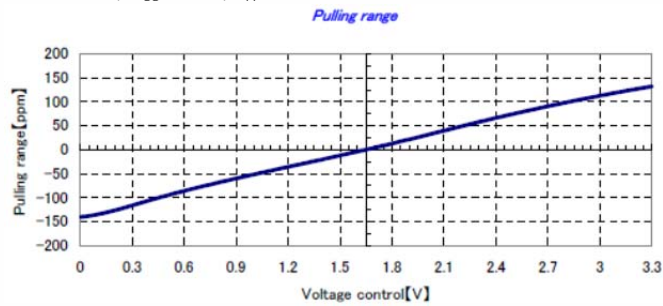

156.25MHz,  $V_{CC} = 3.3V$ ,  $T_A = +25^\circ V$

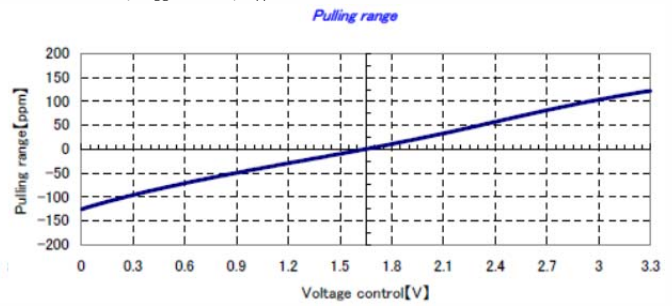

#### Frequency Deviation – Gain Transfer [typical]

122.88MHz,  $V_{CC} = 3.3V$ ,  $T_A = +25^\circ V$

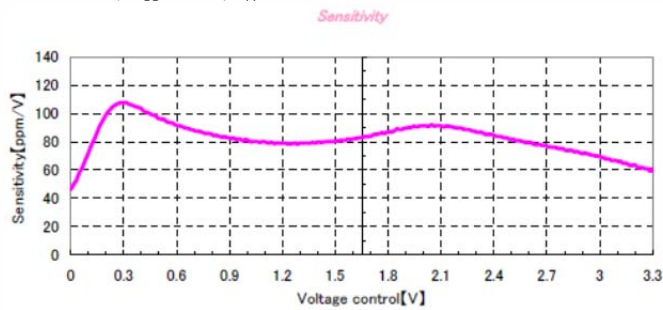

156.25MHz,  $V_{CC} = 3.3V$ ,  $T_A = +25^\circ V$

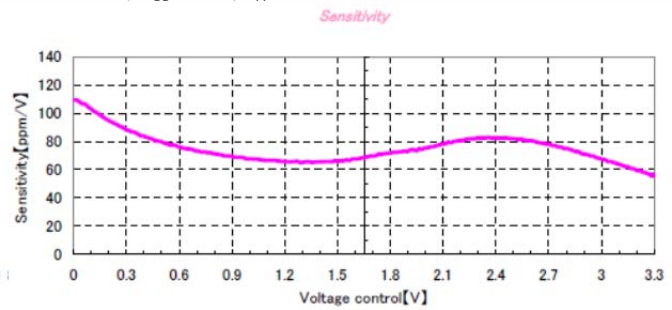



### Electrical Specifications

#### Performance Data

##### Phase Noise [typical]

122.88MHz,  $V_{CC} = 3.3V$ ,  $V_C = 1.65V$ ,  $T_A = +25^\circ C$

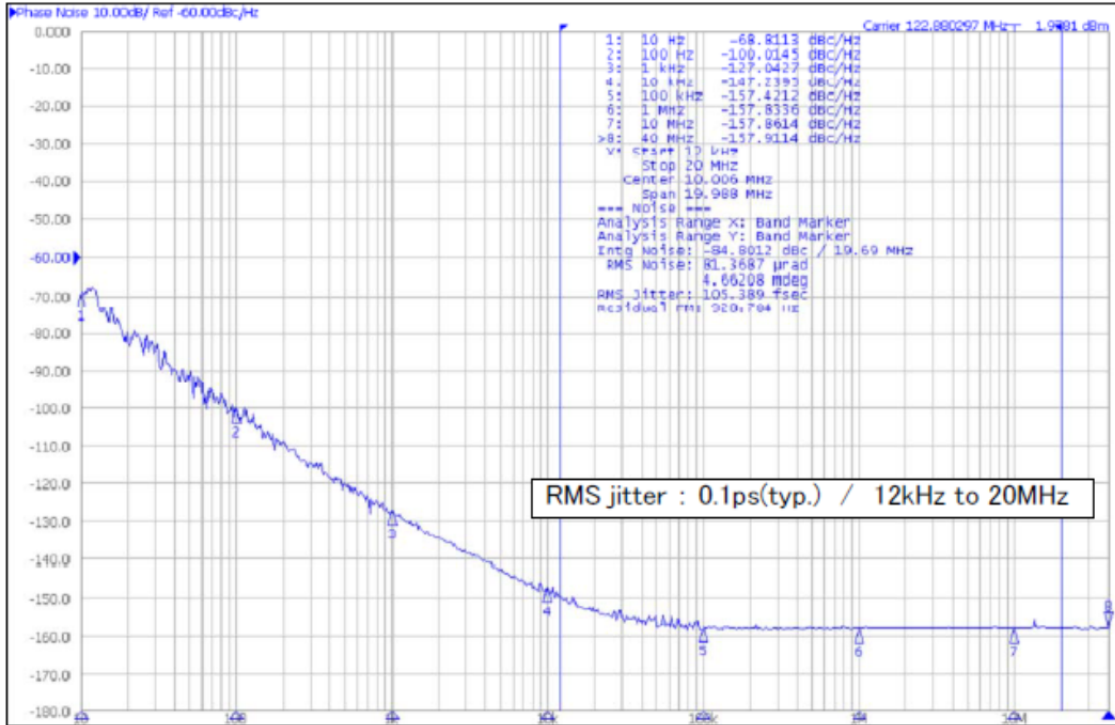

156.25MHz,  $V_{CC} = 3.3V$ ,  $V_C = 1.65V$ ,  $T_A = +25^\circ C$

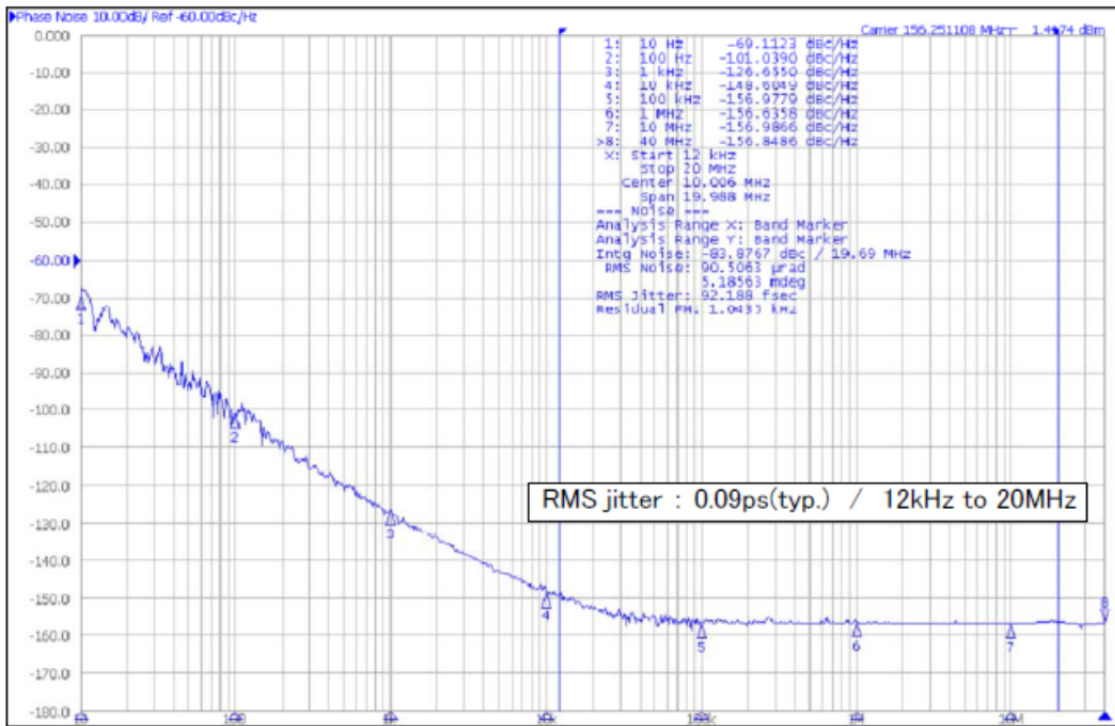

## Mechanical Specifications

### Package Drawing

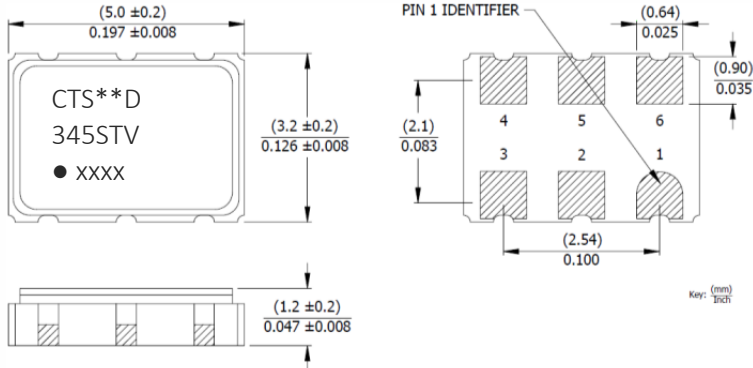

### Marking Information

- \*\* - Manufacturing Site Code.
- D – Date Code. See Table I for codes.
- ST – Frequency Stability/Temperature Code. [Refer to Ordering Information]
- V – Voltage Code. L = 3.3V
- xxxx – Frequency Code. 4-digits required for frequencies 100MHz and above. [See document 016-1454-0, Frequency Code Tables.]

### Recommended Pad Layout

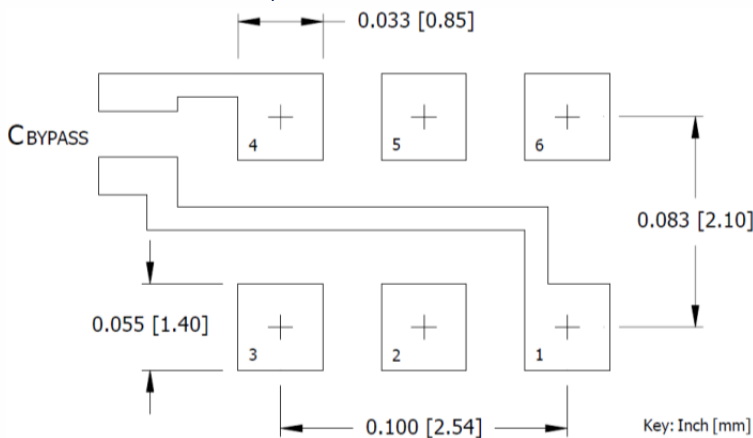

### Notes

- Termination pads (e4). Barrier-plating is nickel [Ni] with gold [Au] flash plate.
- Reflow conditions per JEDEC J-STD-020; +260°C maximum, 20 seconds.
- MSL = 1.

### Pin Assignments

Pin	Symbol	Function
1	V <sub>C</sub>	Control Voltage
2	EOH	Enable
3	GND	Circuit & Package
4	Output	RF Output
5	Output	RF Output, Complementary
6	V <sub>CC</sub>	Supply Voltage

Table I - Date Code

		MONTH															
YEAR		JAN	FEB	MAR	APR	MAY	JUN	JUL	AUG	SEP	OCT	NOV	DEC				
2001	2005	2009	2013	2017	A	B	C	D	E	F	G	H	J	K	L	M	
2002	2006	2010	2014	2018	N	P	Q	R	S	T	U	V	W	X	Y	Z	
2003	2007	2011	2015	2019	a	b	c	d	e	f	g	h	j	k	l	m	
2004	2008	2012	2016	2020	n	p	q	r	s	t	u	v	w	x	y	z	

### Packaging - Tape and Reel

#### Tape Drawing



#### Reel Drawing



#### Notes

1. Device quantity is 1k pieces maximum per 180mm reel.
2. Complete CTS part number, frequency value and date code information must appear on reel and carton labels.

## Данный компонент на территории Российской Федерации

### Вы можете приобрести в компании MosChip.

Для оперативного оформления запроса Вам необходимо перейти по данной ссылке:

<http://moschip.ru/get-element>

Вы можете разместить у нас заказ для любого Вашего проекта, будь то серийное производство или разработка единичного прибора.

В нашем ассортименте представлены ведущие мировые производители активных и пассивных электронных компонентов.

Нашей специализацией является поставка электронной компонентной базы двойного назначения, продукции таких производителей как XILINX, Intel (ex.ALTERA), Vicor, Microchip, Texas Instruments, Analog Devices, Mini-Circuits, Amphenol, Glenair.

Сотрудничество с глобальными дистрибьюторами электронных компонентов, предоставляет возможность заказывать и получать с международных складов практически любой перечень компонентов в оптимальные для Вас сроки.

На всех этапах разработки и производства наши партнеры могут получить квалифицированную поддержку опытных инженеров.

Система менеджмента качества компании отвечает требованиям в соответствии с ГОСТ Р ИСО 9001, ГОСТ РВ 0015-002 и ЭС РД 009

### Офис по работе с юридическими лицами:

105318, г.Москва, ул.Щербаковская д.3, офис 1107, 1118, ДЦ «Щербаковский»

Телефон: +7 495 668-12-70 (многоканальный)

Факс: +7 495 668-12-70 (доб.304)

E-mail: [info@moschip.ru](mailto:info@moschip.ru)

Skype отдела продаж:

moschip.ru

moschip.ru\_4

moschip.ru\_6

moschip.ru\_9