

Photomicrosensor (Transmissive) EE-SX3161-W11/4161-W11

⚠ Be sure to read Precautions on page 24.

■ Dimensions

Note: All units are in millimeters unless otherwise indicated.

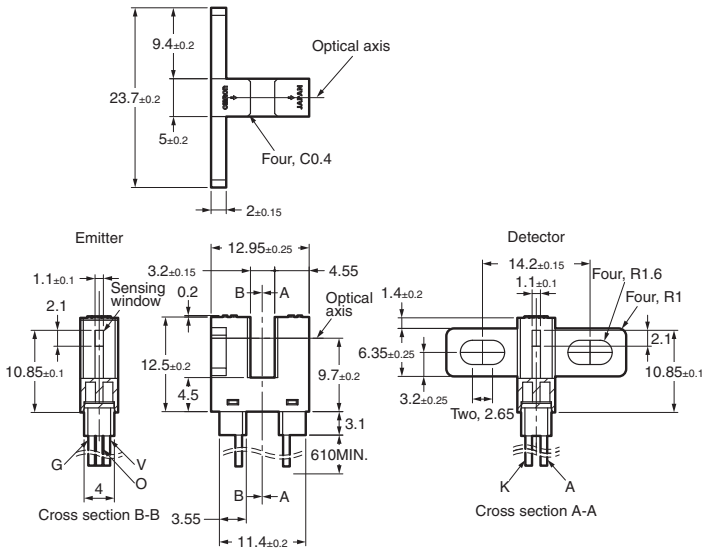

Internal Circuit

Terminal No.	Color	Name
A	Red	Anode
K	Black	Cathode
V	White	Power supply (V _{CC})
O	Blue	Output (OUT)
G	Green	Ground (GND)

Unless otherwise specified, the tolerances are as shown below.

Dimensions	Tolerance
3 mm max.	±0.3
3 < mm ≤ 6	±0.375
6 < mm ≤ 10	±0.45
10 < mm ≤ 18	±0.55
18 < mm ≤ 30	±0.65

■ Features

- Dust-proof model.
- Light-receiving element and amplification circuits contained in one chip.
- Can use a power supply voltage of 4.5 to 16 V.
- Connects directly to C-MOS or TTL.
- Dark-ON Sensor: EE-SX3161-W11
- Light-ON Sensor: EE-SX4161-W11
- Pre-wired Sensors (AWG28).
- Solder-less lead wire connection to increase reliability.

■ Absolute Maximum Ratings (Ta = 25°C)

Item	Symbol	Rated value
Emitter	Forward current	I _F 50 mA (see note 1)
	Reverse voltage	V _R 4 V
Detector	Power supply voltage	V _{CC} 16 V
	Output voltage	V _{OUT} 28 V
	Output current	I _{OUT} 16 mA
	Permissible output dissipation	P _{OUT} 250 mW (see note 1)
Ambient temperature	Operating	T _{opr} -25°C to 75°C
	Storage	T _{stg} -25°C to 85°C

- Note:**
1. Refer to the temperature rating chart if the ambient temperature exceeds 25°C.
 2. If you mount the Sensor with screws, use M3 screws, and flat washers and use a tightening torque of 0.5 N·m max.

■ Electrical and Optical Characteristics (Ta = 25°C)

Item	Symbol	Value	Condition
Emitter	Forward voltage	V _F 1.2 V typ., 1.5 V max.	I _F = 20 mA
	Reverse current	I _R 0.01 μA typ., 10 μA max.	V _R = 4 V
	Peak emission wavelength	λ _P 940 nm	I _F = 20 mA
Detector	Low-level output voltage	V _{OL} 0.12 V typ., 0.4 V max.	V _{CC} = 4.5 to 16 V, I _{OL} = 16 mA, I _F = 0 mA (EE-SX3161), I _F = 10 mA (EE-SX4161)
	High-level output voltage	V _{OH} 15 V min.	V _{CC} = 16 V, R _L = 1 kΩ, I _F = 10 mA (EE-SX3161), I _F = 0 mA (EE-SX4161)
	Current consumption	I _{CC} 3.2 mA typ., 10 mA max.	V _{CC} = 16 V
	Peak spectral sensitivity wavelength	λ _P 870 nm	V _{CC} = 4.5 to 16 V
LED current when output is OFF	I _{FT}	2 mA typ., 10 mA max.	V _{CC} = 4.5 to 16 V
LED current when output is ON			
Hysteresis	ΔH	15% typ.	V _{CC} = 4.5 to 16 V (see note 1)
Response frequency	f	3kHz min.	V _{CC} = 4.5 to 16 V, I _F = 15 mA, I _{OL} = 16 mA (see note 2)
Response delay time	t _{PLH} (t _{PHL})	3 μs typ.	V _{CC} = 4.5 to 16 V, I _F = 15 mA, I _{OL} = 16 mA (see note 3)
Response delay time	t _{PHL} (t _{PLH})	20 μs typ.	V _{CC} = 4.5 to 16 V, I _F = 15 mA, I _{OL} = 16 mA (see note 3)

- Note:** 1. Hysteresis denotes the difference in forward LED current value, expressed in percentage, calculated from the respective forward LED currents when the photo IC in turned from ON to OFF and when the photo IC in turned from OFF to ON.
2. The value of the response frequency is measured by rotating the disk as shown below.

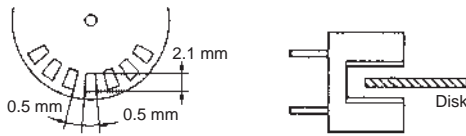

3. The following illustrations show the definition of response delay time. The value in the parentheses applies to the EE-SX4161.

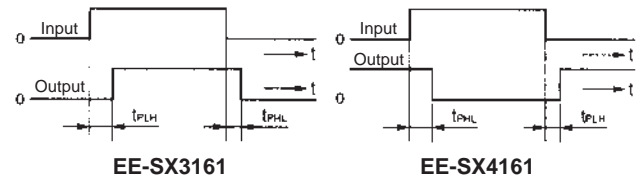

Engineering Data

Note: The values in the parentheses apply to the EE-SX4161.

Forward Current vs. Collector Dissipation Temperature Rating

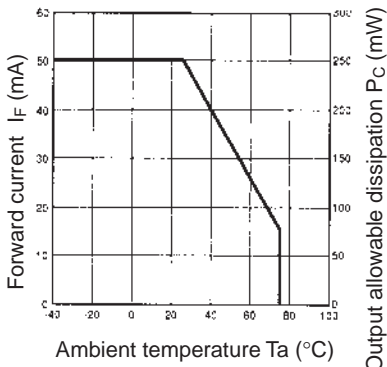

Forward Current vs. Forward Voltage Characteristics (Typical)

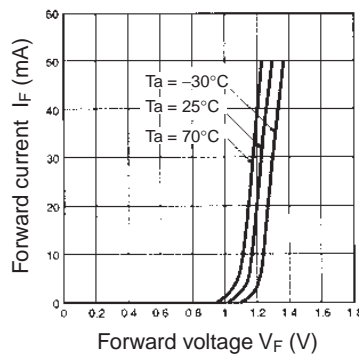

LED Current vs. Supply Voltage (Typical)

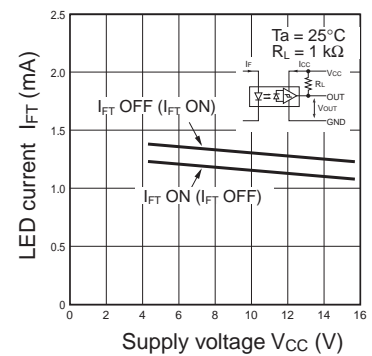

LED Current vs. Ambient Temperature Characteristics (Typical)

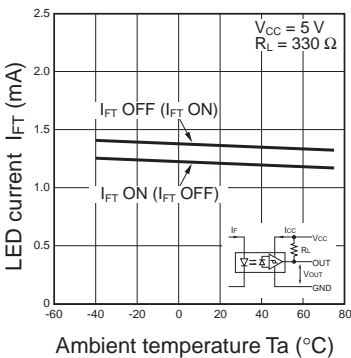

Low-level Output Voltage vs. Output Current (Typical)

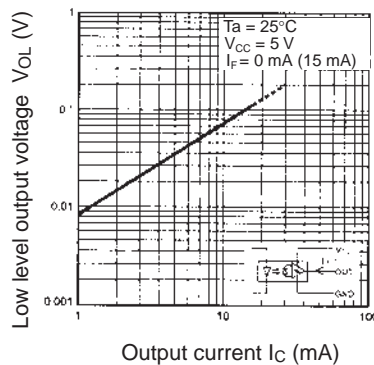

Low-level Output Voltage vs. Ambient Temperature Characteristics (Typical)

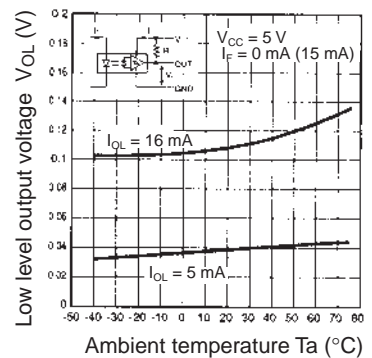

Current Consumption vs. Supply Voltage (Typical)

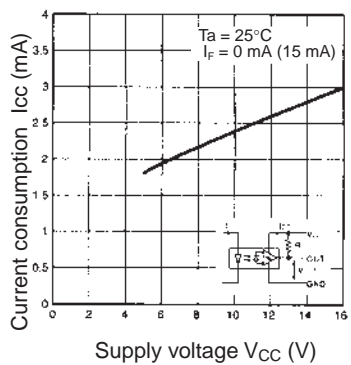

Response Delay Time vs. Forward Current (Typical)

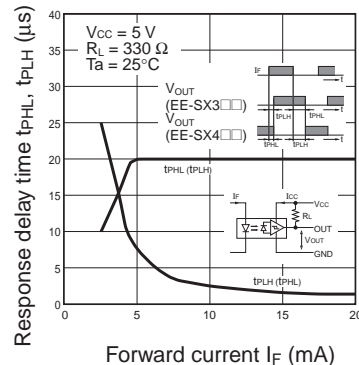

Repeat Sensing Position Characteristics (Typical)

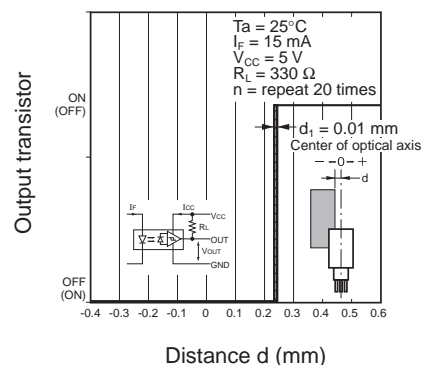

Данный компонент на территории Российской Федерации

Вы можете приобрести в компании MosChip.

Для оперативного оформления запроса Вам необходимо перейти по данной ссылке:

<http://moschip.ru/get-element>

Вы можете разместить у нас заказ для любого Вашего проекта, будь то серийное производство или разработка единичного прибора.

В нашем ассортименте представлены ведущие мировые производители активных и пассивных электронных компонентов.

Нашей специализацией является поставка электронной компонентной базы двойного назначения, продукции таких производителей как XILINX, Intel (ex.ALTERA), Vicor, Microchip, Texas Instruments, Analog Devices, Mini-Circuits, Amphenol, Glenair.

Сотрудничество с глобальными дистрибьюторами электронных компонентов, предоставляет возможность заказывать и получать с международных складов практически любой перечень компонентов в оптимальные для Вас сроки.

На всех этапах разработки и производства наши партнеры могут получить квалифицированную поддержку опытных инженеров.

Система менеджмента качества компании отвечает требованиям в соответствии с ГОСТ Р ИСО 9001, ГОСТ РВ 0015-002 и ЭС РД 009

Офис по работе с юридическими лицами:

105318, г.Москва, ул.Щербаковская д.3, офис 1107, 1118, ДЦ «Щербаковский»

Телефон: +7 495 668-12-70 (многоканальный)

Факс: +7 495 668-12-70 (доб.304)

E-mail: info@moschip.ru

Skype отдела продаж:

moschip.ru

moschip.ru_4

moschip.ru_6

moschip.ru_9