



Features

- $P_{1dB} = 33.5\text{dBm}$ at 5V, 2.4GHz
- 802.11g 54 Mb/s Class AB Performance
- $P_{OUT} = 26\text{dBm}$ at 2.5% EVM, $V_{CC} = 5\text{V}$
- $P_{OUT} = 27\text{dBm}$ at 2.5% EVM, $V_{CC} = 6\text{V}$
- On-Chip Output Power Detector
- Input Prematched to $\sim 50\Omega$
- Proprietary Low Thermal Resistance Package
- Hand Solderable and Easy Rework
- Power Up/Down control $< 1\mu\text{s}$

Applications

- 802.16 WiMAX Driver or Output Stage
- 2.4GHz 802.11 WiFi and ISM Applications

Functional Block Diagram

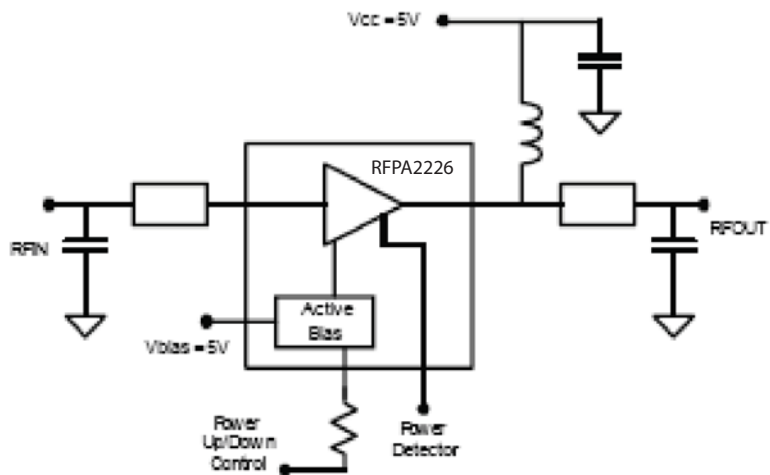

Functional Block Diagram

Product Description

RFMD's RFPA2226 is a high linearity single stage class AB Heterojunction Bipolar Transistor (HBT) amplifier housed in a proprietary surface-mountable plastic encapsulated package. This HBT amplifier is made with InGaP on GaAs device technology and fabricated with MOCVD for an ideal combination of low cost and high reliability. This product is specifically designed as a flexible final or driver stage for 802.16 and 802.11 equipment in the 2.2GHz to 2.7GHz bands. It can run from a 3V to 6V supply. It is prematched to $\sim 50\Omega$ on the input for broadband performance and ease of matching at the board level. It features an output power detector, on/off power control, ESD protection, excellent overall robustness and a proprietary hand reworkable and thermally enhanced QFN package. This product features a RoHS Compliant and Green package with matte tin finish.

Ordering Information

RFPA2226SQ	Standard 25-piece bag
RFPA2226SR	Standard 100-piece reel
RFPA2226	Standard 1000-piece reel
RFPA2226-EVB1	Evaluation Board 2.4GHz to 2.5GHz Tune
RFPA2226-EVB2	Evaluation Board 2.5GHz to 2.7GHz Tune

Optimum Technology Matching® Applied

- | | | | |
|---|--------------------------------------|-------------------------------------|------------------------------------|
| <input type="checkbox"/> GaAs HBT | <input type="checkbox"/> SiGe BiCMOS | <input type="checkbox"/> GaAs pHEMT | <input type="checkbox"/> GaN HEMT |
| <input type="checkbox"/> GaAs MESFET | <input type="checkbox"/> Si BiCMOS | <input type="checkbox"/> Si CMOS | <input type="checkbox"/> BiFET HBT |
| <input checked="" type="checkbox"/> InGaP HBT | <input type="checkbox"/> SiGe HBT | <input type="checkbox"/> Si BJT | <input type="checkbox"/> LD MOS |

RF MICRO DEVICES®, RFMD®, Optimum Technology Matching®, Enabling Wireless Connectivity™, PowerStar®, POLARIS™ TOTAL RADIO™ and UltimateBlue™ are trademarks of RFMD, LLC. BLUETOOTH is a trademark owned by Bluetooth SIG, Inc., U.S.A. and licensed for use by RFMD. All other trade names, trademarks and registered trademarks are the property of their respective owners. ©2012, RF Micro Devices, Inc.

Absolute Maximum Ratings

Parameter	Rating	Unit
VC1 Collector Bias Current (I_{VC1})	1500	mA
**Device Voltage (V_D)	7.0	V
Power Dissipation	6	W
*Max RF output Power for 50Ω continuous long term operation	30	dBm
Max RF Input Power for 50W output load	28	dBm
Max RF Input Power for 10:1 VSWR output load	23	dBm
Junction Temp (T_J)	+150	°C
Operating Lead Temperature (T_L)	-40 to +85	°C
Storage Temperature Range	-40 to +150	°C
ESD Rating - Human Body Model	1000	V

*Note: With specified application circuit

**Note: No RF Drive

Operation of this device beyond any one of these limits may cause permanent damage. For reliable continuous operation, the device voltage and current must not exceed the maximum operating values specified in the table on page one.

Bias Conditions should also satisfy the following expression: $I_D V_D < (T_J - T_L) / R_{TH, j-H}$



Caution! ESD sensitive device.

Exceeding any one or a combination of the Absolute Maximum Rating conditions may cause permanent damage to the device. Extended application of Absolute Maximum Rating conditions to the device may reduce device reliability. Specified typical performance or functional operation of the device under Absolute Maximum Rating conditions is not implied.

The information in this publication is believed to be accurate and reliable. However, no responsibility is assumed by RF Micro Devices, Inc. ("RFMD") for its use, nor for any infringement of patents, or other rights of third parties, resulting from its use. No license is granted by implication or otherwise under any patent or patent rights of RFMD. RFMD reserves the right to change component circuitry, recommended application circuitry and specifications at any time without prior notice.



RFMD Green: RoHS compliant per EU Directive 2002/95/EC, halogen free per IEC 61249-2-21, < 1000ppm each of antimony trioxide in polymeric materials and red phosphorus as a flame retardant, and <2% antimony in solder.

Parameter	Specification			Unit	Condition
	Min.	Typ.	Max.		
Frequency of Operation,	2200		2700	MHz	
Output Power at 1dB Compression	31.5	33.0		dBm	2.7 GHz
Small Signal Gain	11.3	12.8		dB	2.7 GHz
EVM		2.5		%	2.7 GHz, 802.11g 54Mb/s at $P_{OUT}=26$ dBm
Third Order Suppression		-45.0	-42.0	dBc	2.7 GHz, $P_{OUT}=23$ dBm per tone
Noise Figure		4.3		dB	2.7 GHz
Worst Case Input Return Loss	8.0	12.0		dB	2.5GHz to 2.7 GHz
Worst Case Output Return Loss	8.0	12.0		dB	2.5GHz to 2.7 GHz
Power Detector Range	0.75		2.2	V	$P_{OUT}=10$ dBm to 30dBm
Quiescent Current	395	445	495	mA	$V_{CC}=5$ V
Power Up Control Current		2.1		mA	$V_{PC}=5$ V
VCC Leakage Current			10	μA	$V_{CC}=5$ V, $V_{PC}=0$ V
Thermal Resistance		12.0		°C/W	junction - lead

Test Conditions: $Z_0=50\Omega$, $V_{CC}=5$ V, $I_Q=445$ mA, $T_{BP}=30$ °C

Typical Performance 2.4GHz to 2.5GHz and 2.5GHz to 2.7GHz App Circuits

($V_{CC} = 5V$, 802.11g 54Mb/s 64QAM)

Parameter	Unit	*2.4GHz	*2.5GHz	**2.6GHz	**2.7GHz
Gain	dB	13.3	13.0	12.8	12.7
P1dB	dBm	33.5	33.3	33.6	33.3
P _{OUT} at 2.5% EVM	dBm	26.0	26.0	26.2	26.0
Current at P _{OUT} at 2.5% EVM	mA	550	545	570	570
Input Return Loss	dB	16.0	12.0	17.0	13.0
Output Return Loss	dB	16.0	16.0	17.0	15.0

*Measured with 2.4GHz to 2.5GHz Applications Circuit

**Measured with 2.5GHz to 2.7GHz Applications Circuit

Pin Out

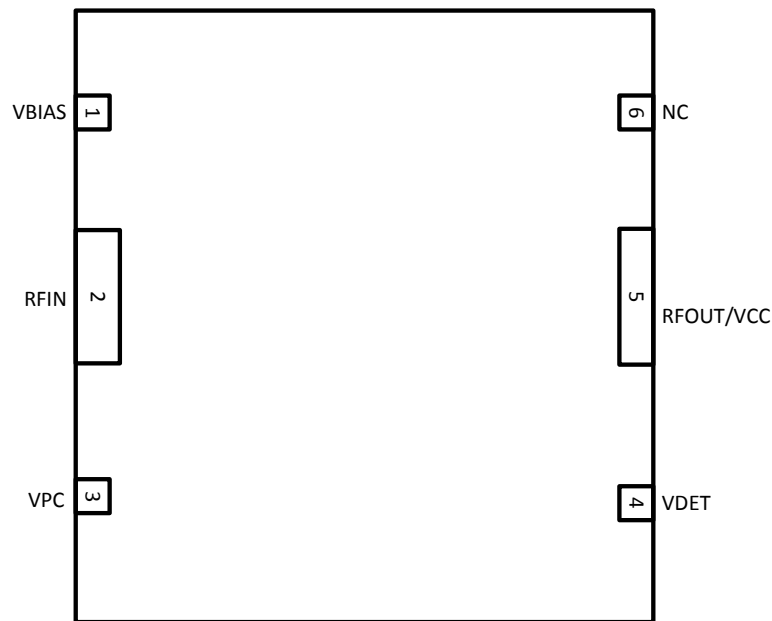

Measured 2.4GHz to 2.5GHz Application Circuit Data

($V_{CC}=V_{PC}=5.0V$ $I_Q=445mA$, $T=25^\circ C$)

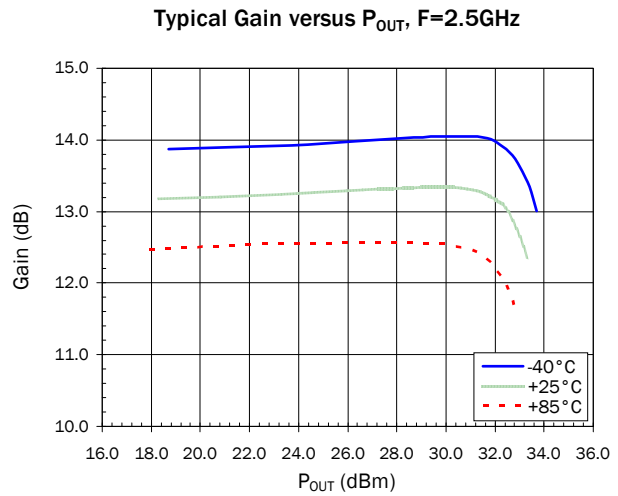
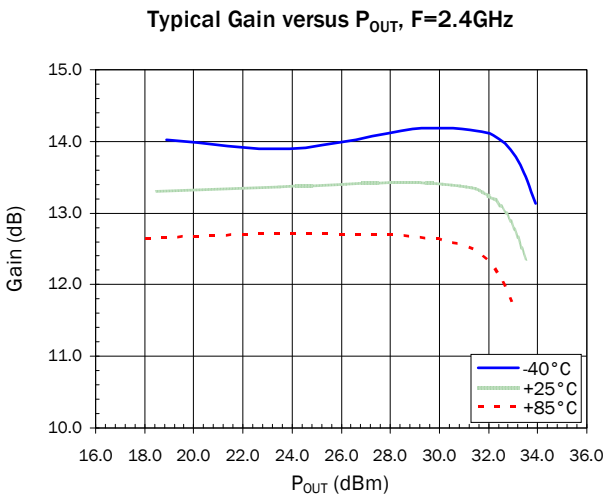
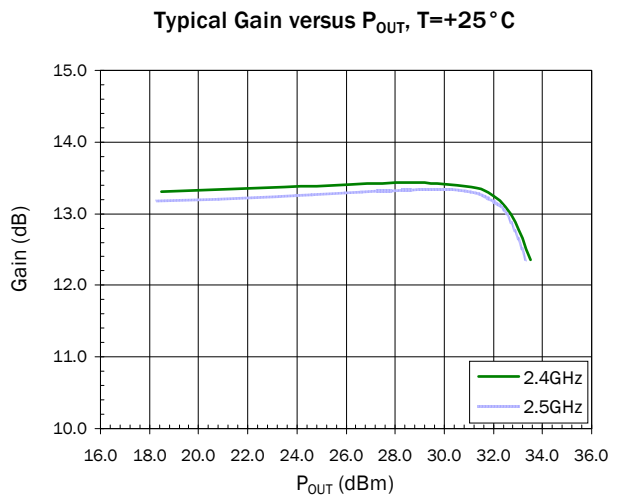
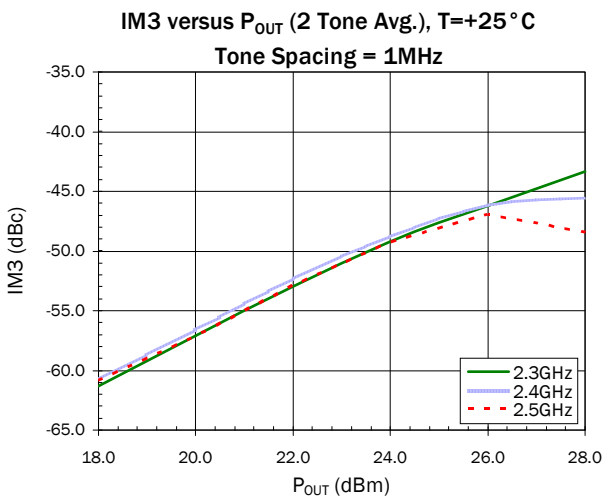
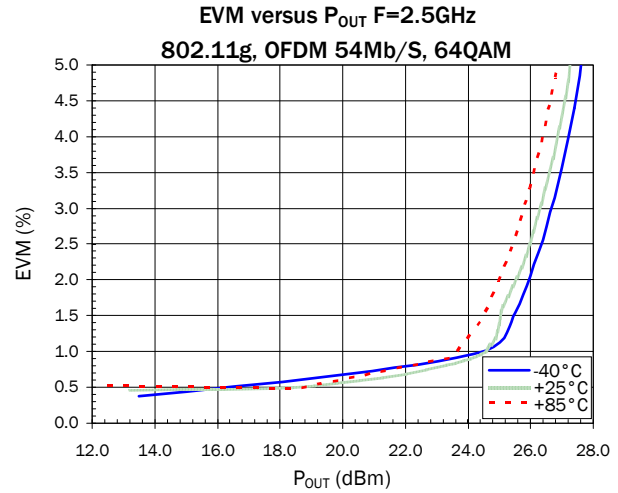
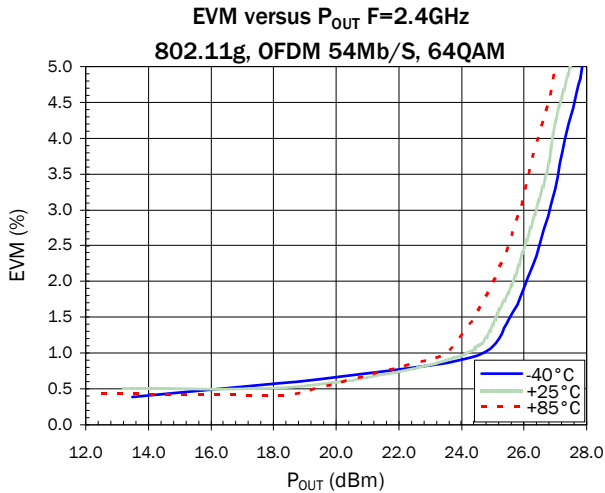

Measured 2.4GHz to 2.5GHz Application Circuit Data

($V_{CC}=V_{PC}=5.0V$ $I_Q=445mA$, $T=25^\circ C$)

Narrowband S11 - Input Return Loss

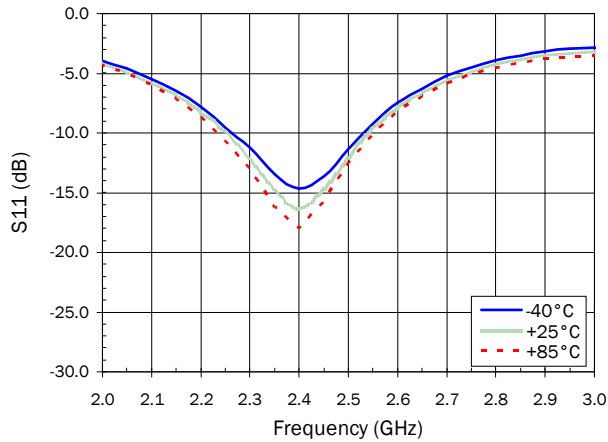

Narrowband S12 - Reverse Isolation

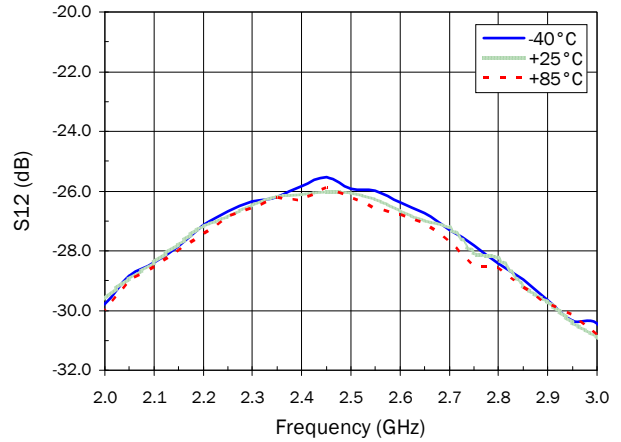

Narrowband S21 - Forward Gain

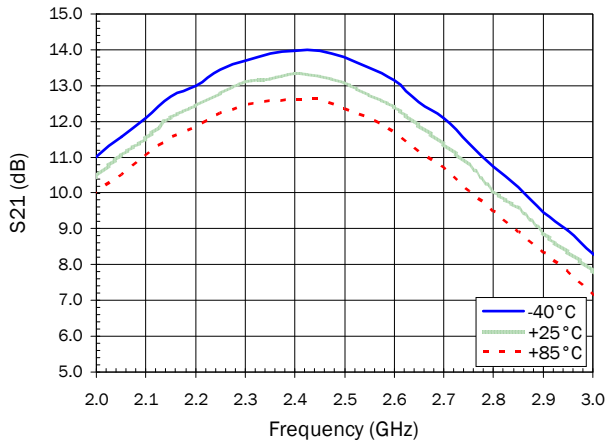

Narrowband S22 - Output Return Loss

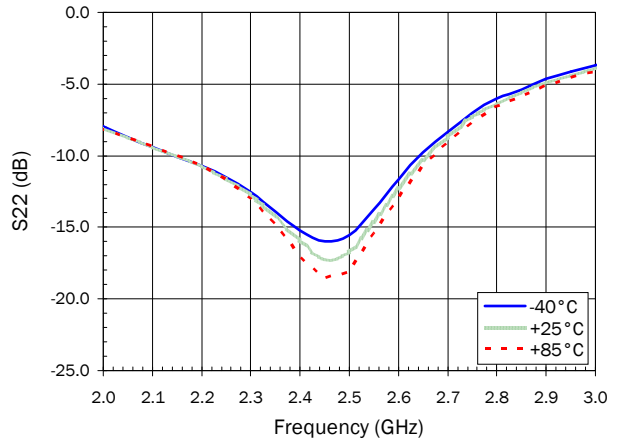

DC Supply Current versus P_{OUT}, F=2.4GHz

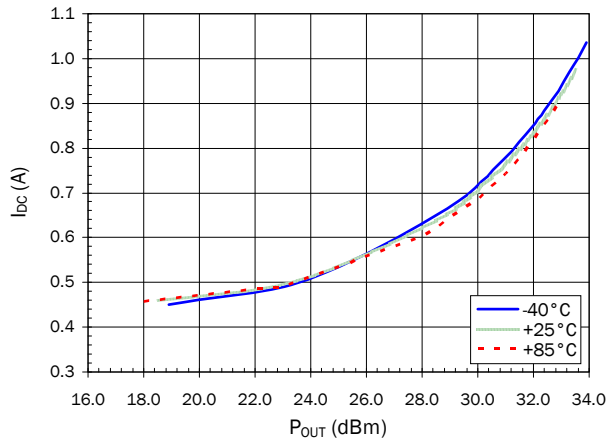

Noise Figure versus Frequency, O.T.

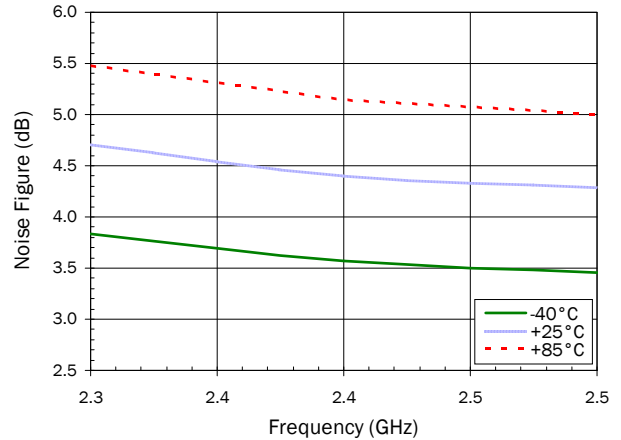

Measured 2.4GHz to 2.5GHz Application Circuit Data

($V_{CC}=V_{PC}=5.0V$ $I_Q=445mA$, $T=25^\circ C$)

RF Power Detector (V_{DET}) versus P_{OUT} , F=2.4GHz

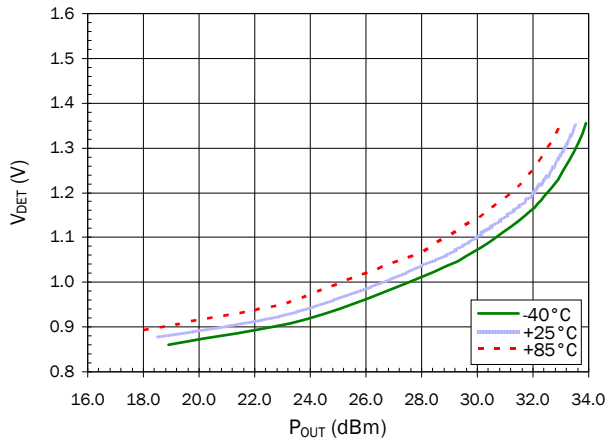

RF Power Detector (V_{DET}) versus P_{OUT} , F=2.5GHz

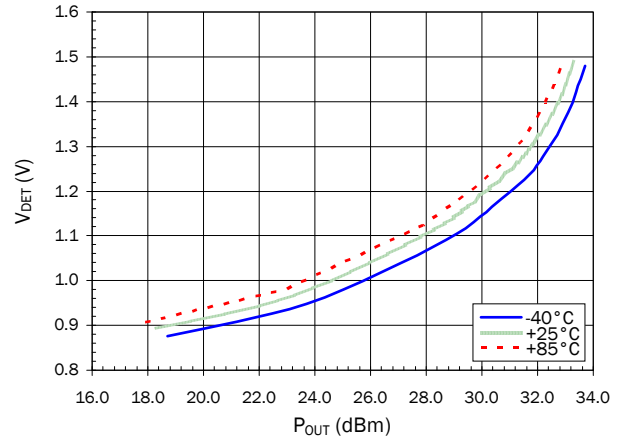

Broadband S11 - Input Return Loss

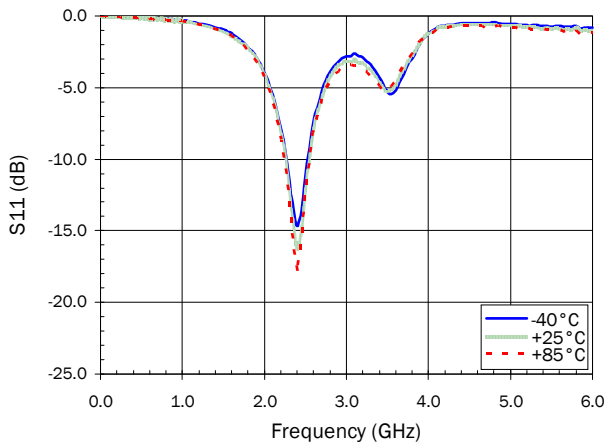

Broadband S12 - Reverse Isolation

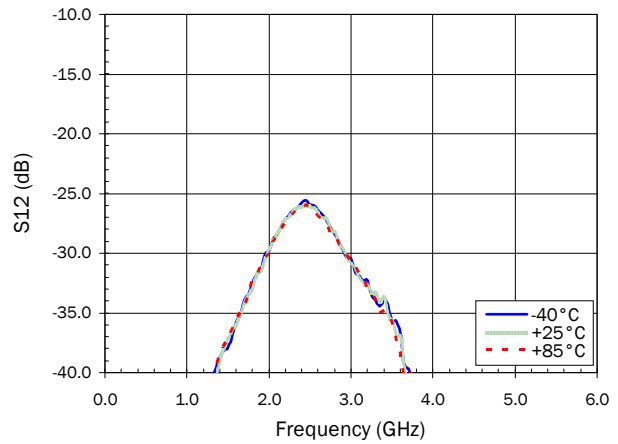

Broadband S21 - Forward Gain

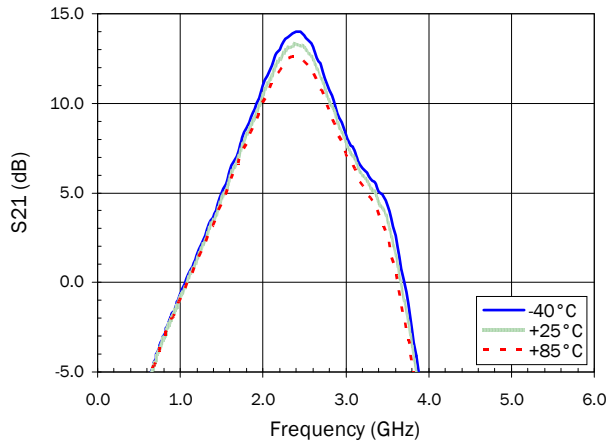

Broadband S22 - Output Return Loss

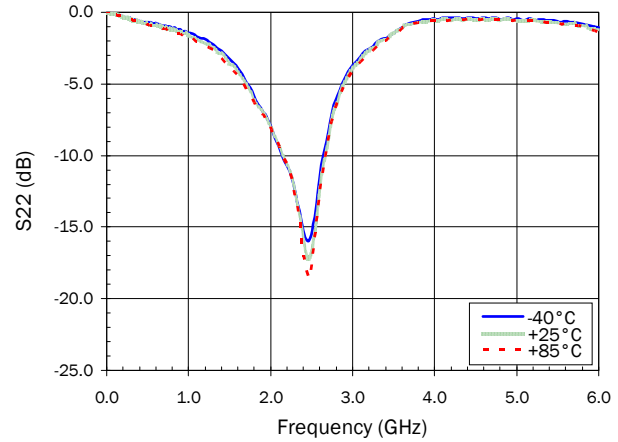

Measured 2.5GHz to 2.7GHz Application Circuit Data

($V_{CC}=V_{PC}=5.0V$ $I_Q=445mA$, $T=25^\circ C$)

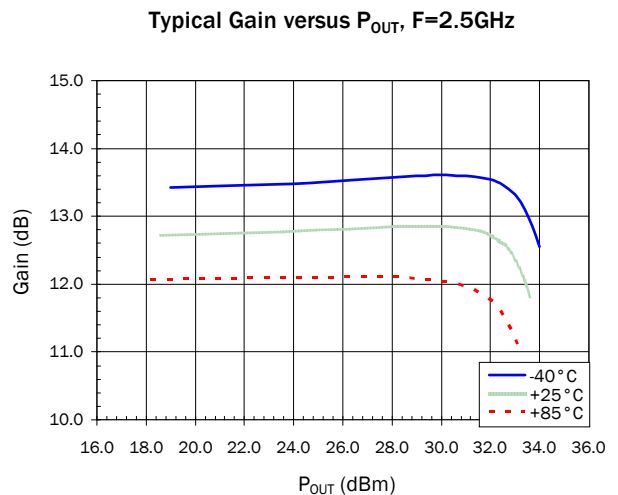
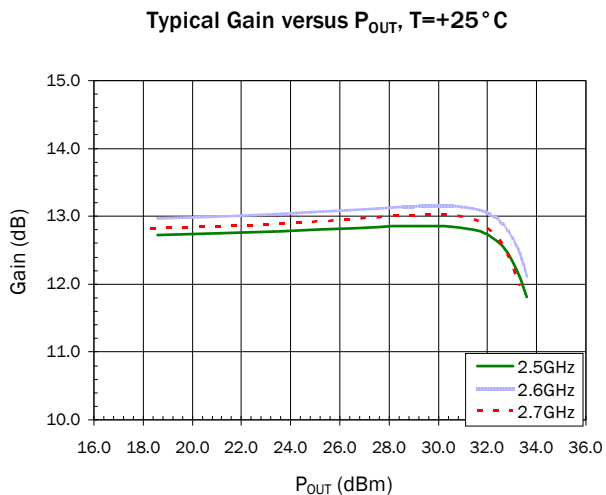
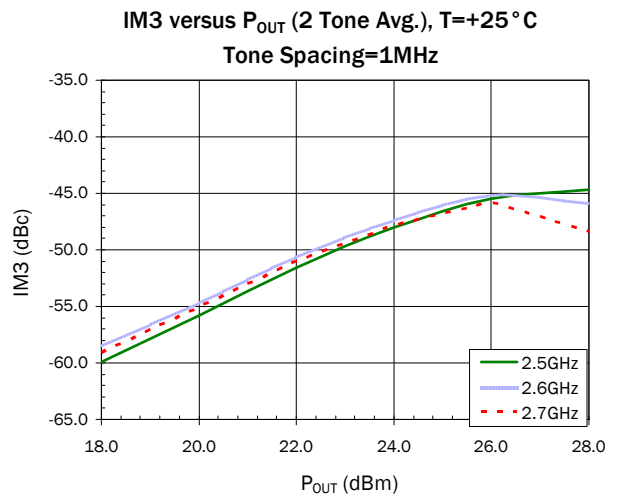
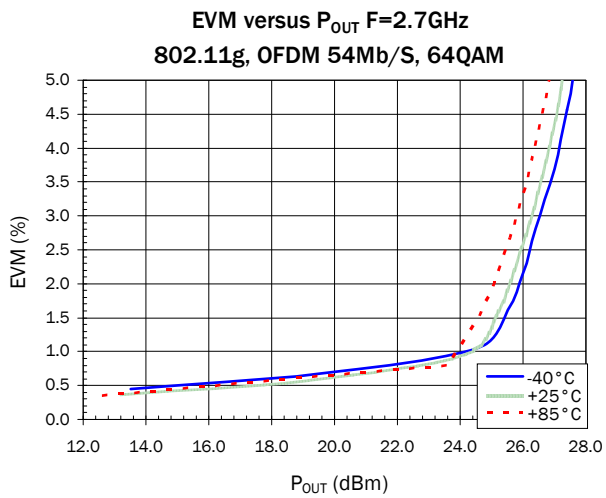
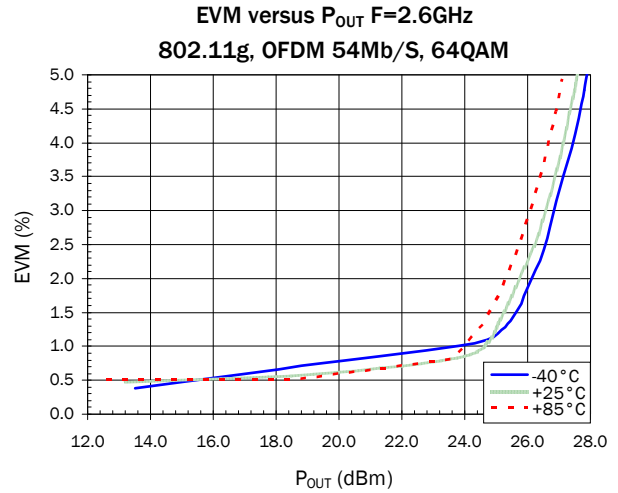
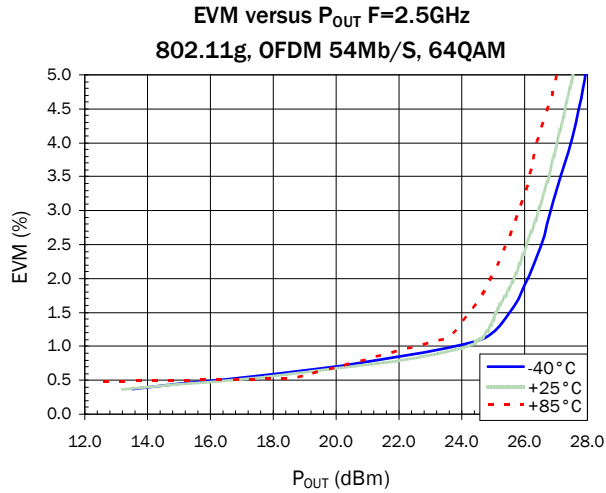

Measured 2.5GHz to 2.7GHz Application Circuit Data

($V_{CC}=V_{PC}=5.0V$ $I_Q=445mA$, $T=25^\circ C$)

Typical Gain versus P_{OUT} , F=2.6GHz

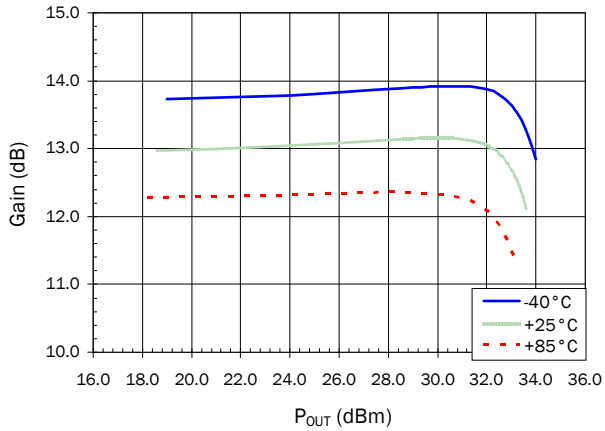

Typical Gain versus P_{OUT} , F=2.7GHz

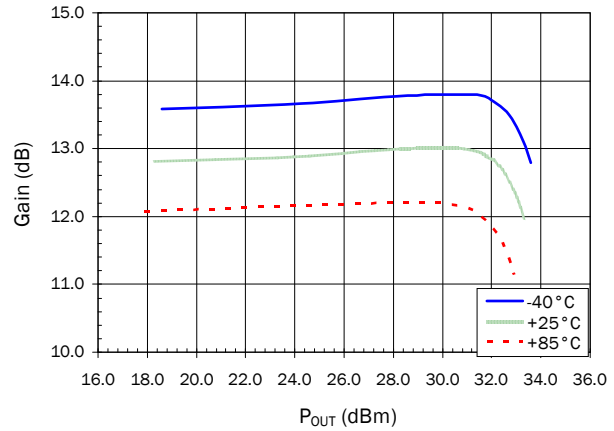

Narrowband S11 - Input Return Loss

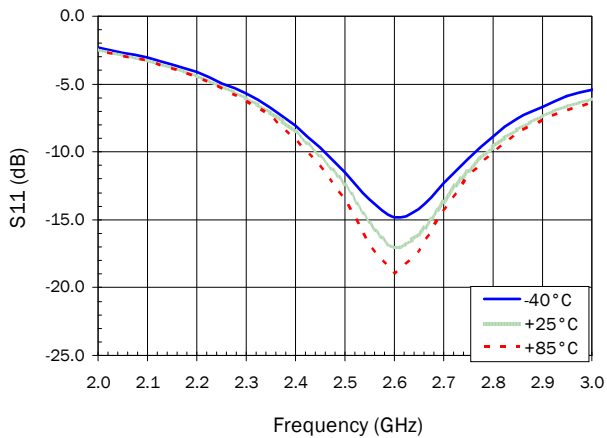

Narrowband S12 - Reverse Isolation

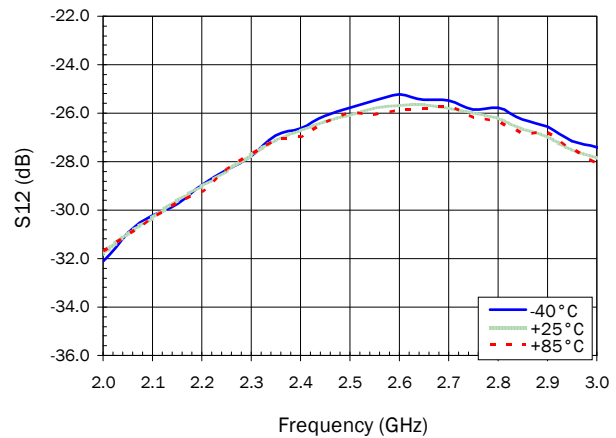

Narrowband S21 - Forward Gain

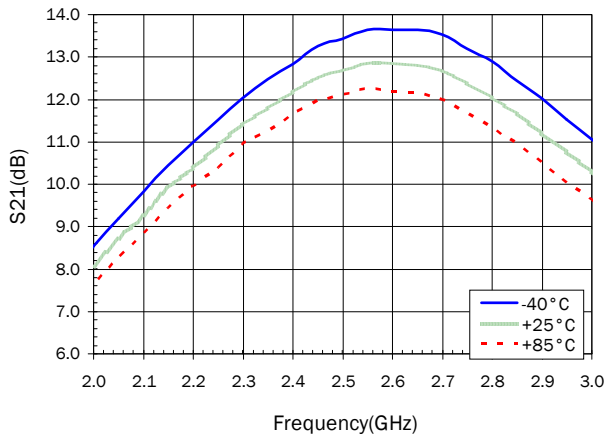

Narrowband S22 - Output Return Loss

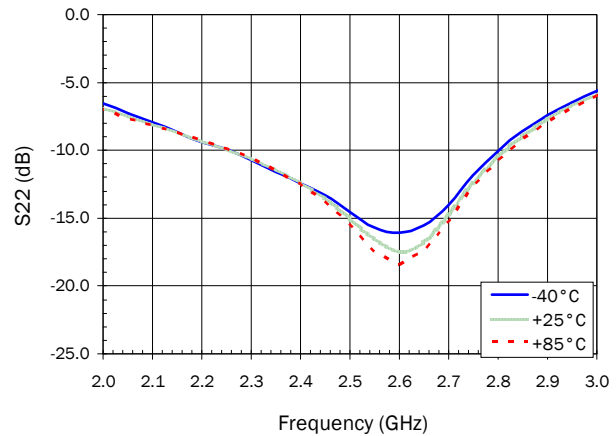

Measured 2.5GHz to 2.7GHz Application Circuit Data

($V_{CC}=V_{PC}=5.0V$ $I_Q=445mA$, $T=25^\circ C$)

DC Supply Current versus P_{OUT} , $T=+25^\circ C$

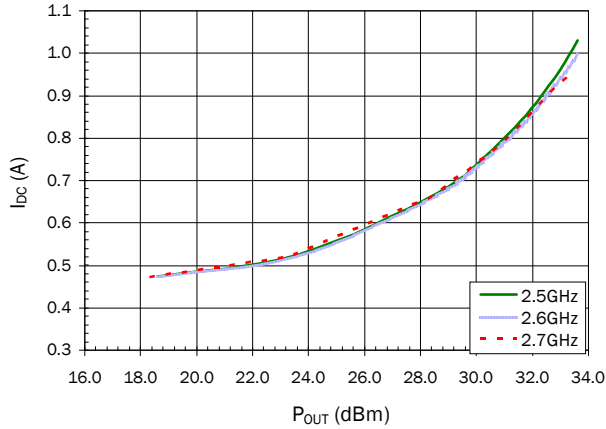

DC Supply Current versus P_{OUT} , $F=2.6GHz$

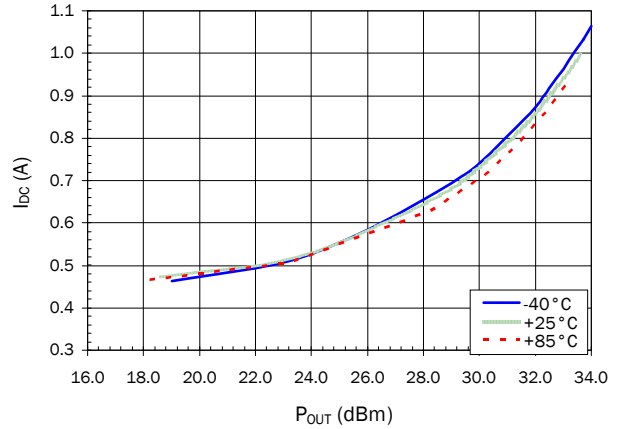

Noise Figure versus Frequency, O.T.

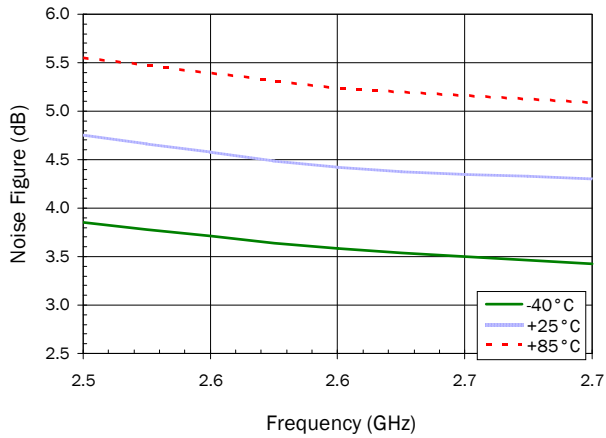

RF Power Detector (V_{DET}) versus P_{OUT} , $F=2.5GHz$

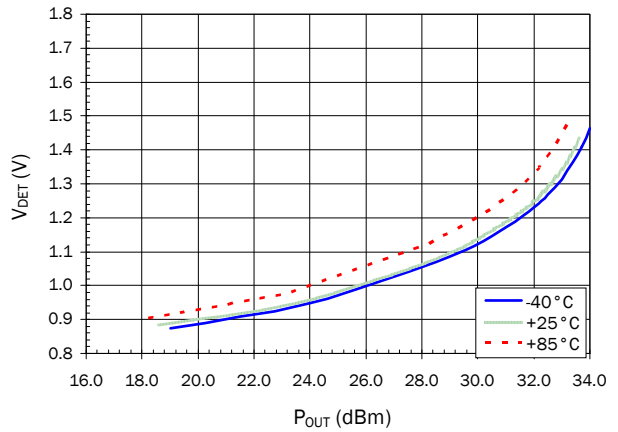

RF Power Detector (V_{DET}) versus P_{OUT} , $F=2.6GHz$

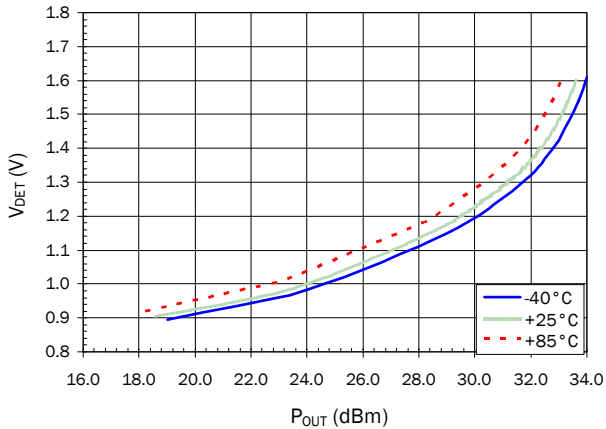

RF Power Detector (V_{DET}) versus P_{OUT} , $F=2.7GHz$

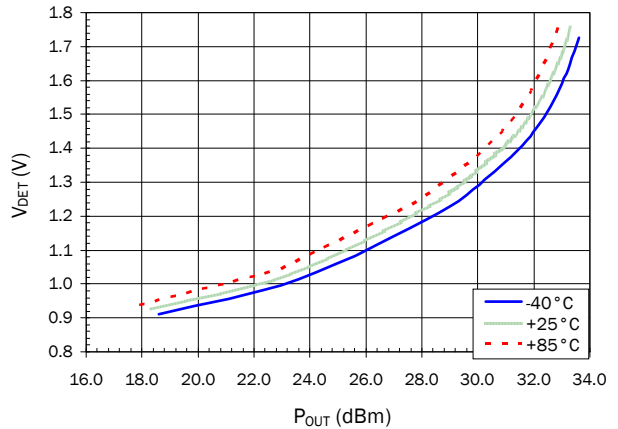

Measured 2.5 GHz to 2.7 GHz Application Circuit Data

($V_{CC}=V_{PC}=5.0V$ $I_Q=445mA$, $T=25^\circ C$)

Broadband S11 - Input Return Loss

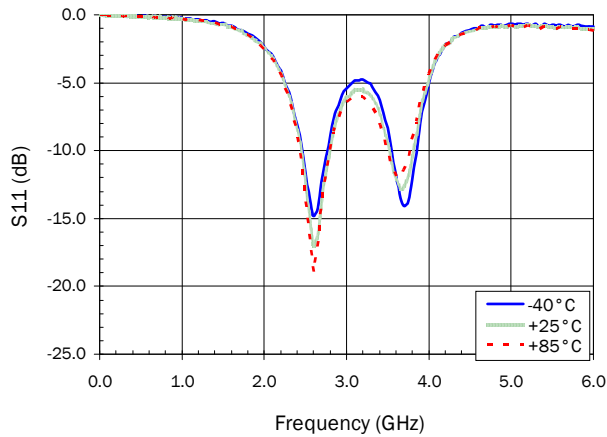

Broadband S12 - Reverse Isolation

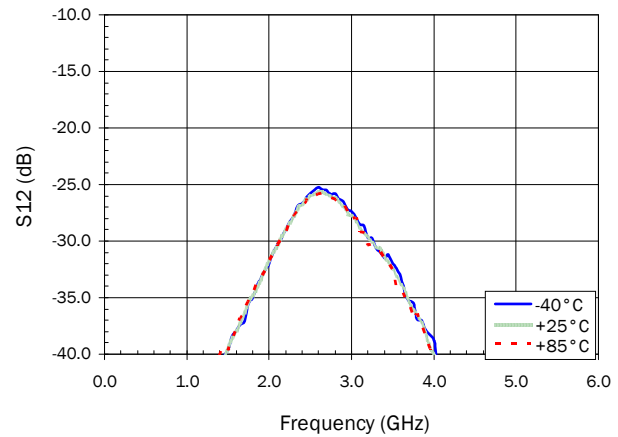

Broadband S21 - Forward Gain

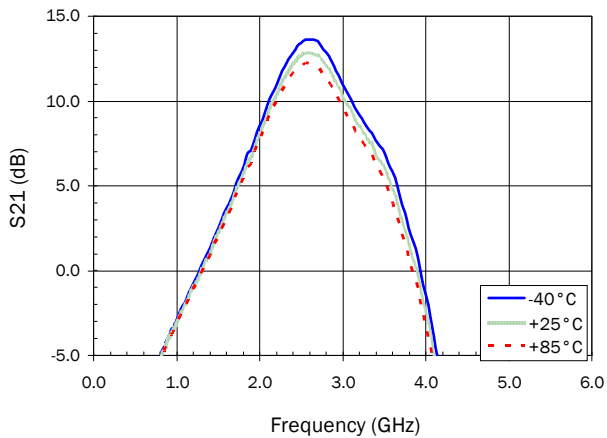

Broadband S22 - Output Return Loss

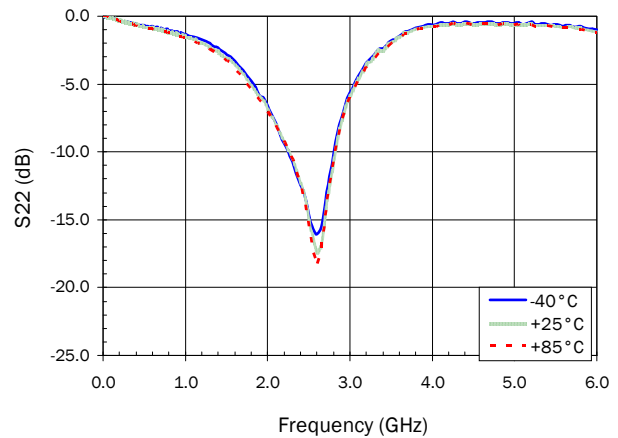

Pin Names and Descriptions

Pin	Name	Description
1	VBIAS	This is the supply voltage for the active bias circuit.
2	RF IN	This is the RF input pin and has a DC voltage present. An external DC block is required.
3	VPC	Power up/down control pin. The voltage on this pin should never exceed the voltage on pin 1 by more than 0.5V unless the supply current from pin 3 is limited < 10mA.
4	VDET	This is the output port for the power detector. It samples the power at the input of the amplifier.
5	RF OUT/VCC	This is the RF output pin and DC connection to the collector.
6	NC	This pin is not connected internal to the package. Buss it to pin 5 as shown on the app circuit to achieve the specified performance.
Pkg Base	GND	These pins are DC connected to the backside paddle. They provide good thermal connection to the backside paddle for hand soldering and rework. Many thermal and electrical GND vias are recommended as shown in the landing pattern.

Package Drawing

Dimensions in millimeters (inches)

Refer to drawing posted at www.rfmd.com for tolerances.

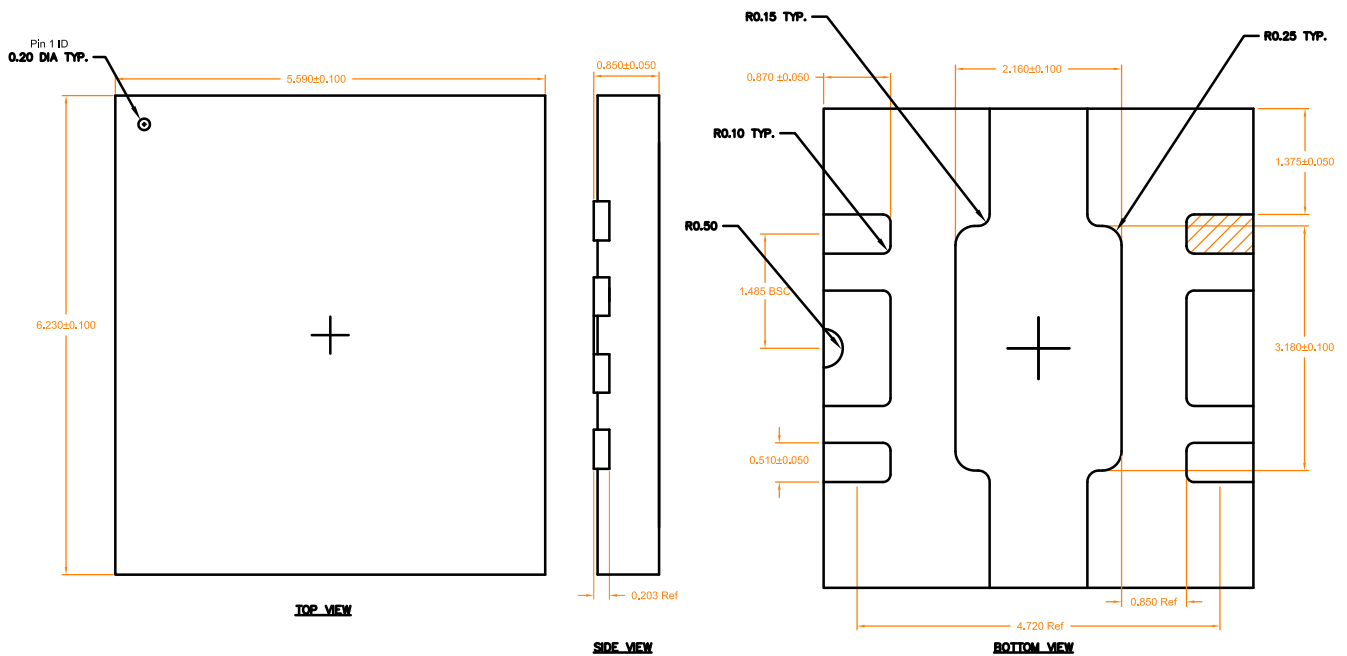

Shaded area represents Pin 1.

PCB Requirements

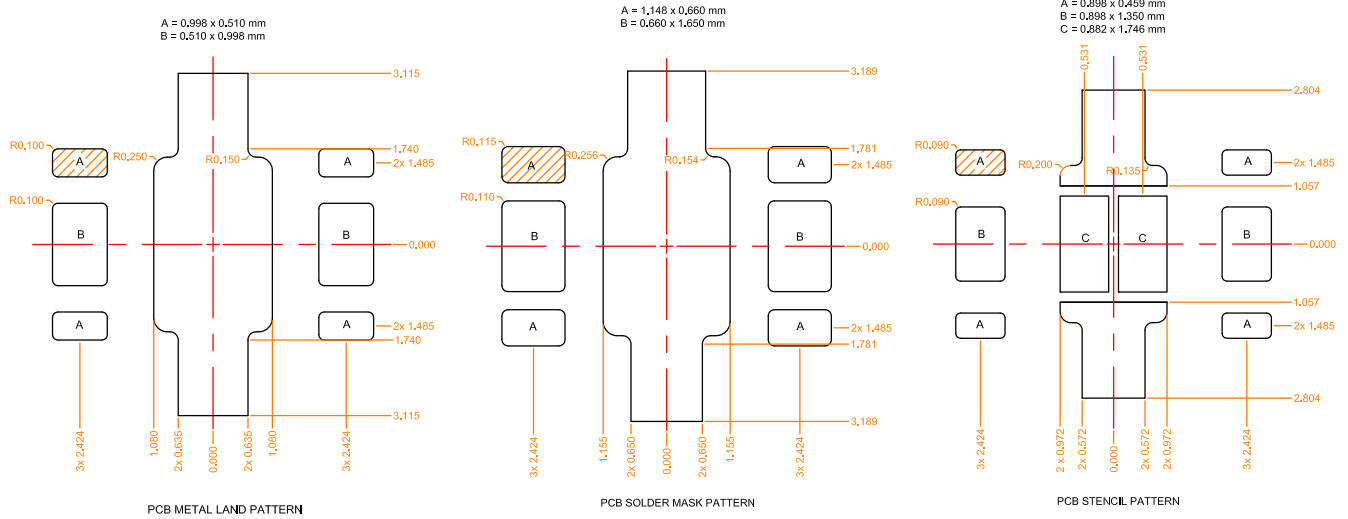

Shaded area represents Pin 1 location.

Application Schematic

(2.4GHz to 2.5GHz)

For $V^+ = V_{CC} = V_{PC} = 5.0V$

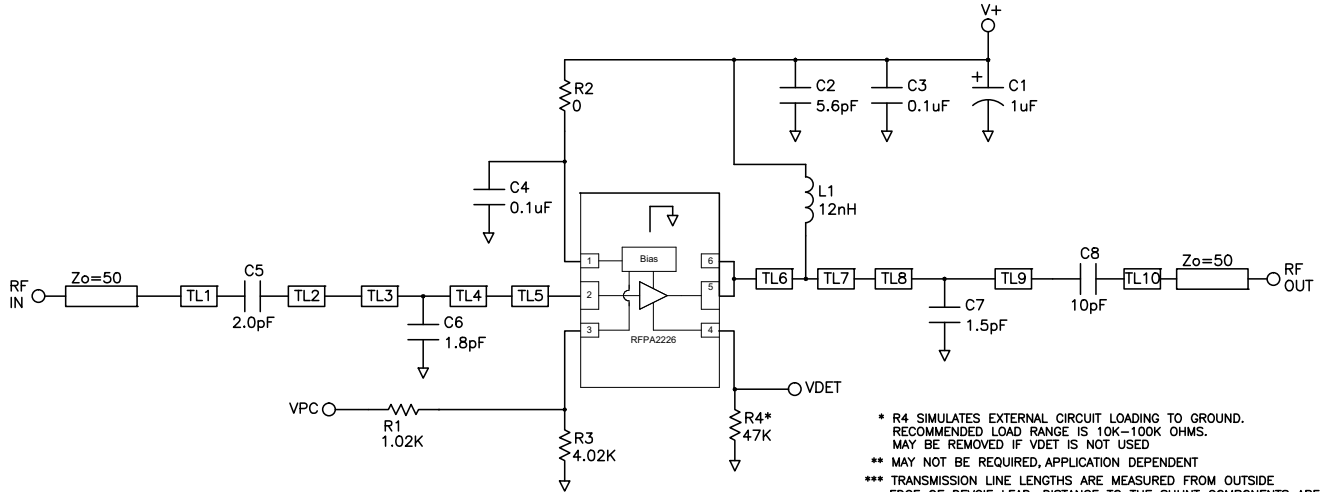

- * R4 SIMULATES EXTERNAL CIRCUIT LOADING TO GROUND. RECOMMENDED LOAD RANGE IS 10K-100K OHMS. MAY BE REMOVED IF VDET IS NOT USED
- ** MAY NOT BE REQUIRED, APPLICATION DEPENDENT
- *** TRANSMISSION LINE LENGTHS ARE MEASURED FROM OUTSIDE EDGE OF DEVICE LEAD. DISTANCE TO THE SHUNT COMPONENTS ARE MEASURED FROM THE MIDDLE EDGE OF THE COMPONENT; DISTANCE TO SERIES COMPONENTS MEASURED FROM INSIDE EDGE OF LAND PAD.

Evaluation Board Layout

(2.4GHz to 2.5GHz)

For $V_+ = V_{CC} = V_{PC} = 5.0V$

Board Material GETEK, 10mil thick, $Dk=3.9$, 2oz. copper

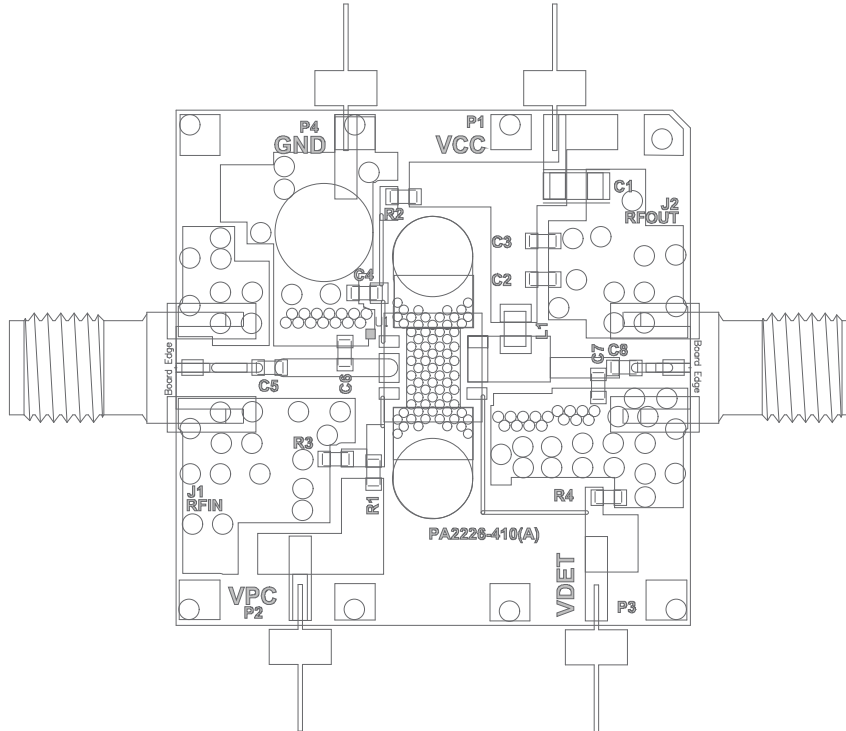

PCB Notes: Do not use less than the recommended number of via holes under the device ground paddle. RF layers thicker than .020 inches (0.5mm) not recommended.

Bill of Materials

(2.4GHz to 2.5GHz)

DESG	Description	Notes
Q1	RFPA2226	DFN
R1	1.02K, Ω , 0603 1%	0402 may be used
R2	0 Ω , 0603	0402 may be used
R3	4.02K, Ω , 0603 1%	0402 may be used
R4	47K, Ω , 0603	0402 may be used
C1	1uF 16V MLCC CAP	Tantalum ok for EVM performance. Use MLCC type for best IM3 levels.
C2	5.6pF CAP, 0603	NPO ROHM MCH185A5R6DK or equiv.
C3, 4	0.1uF CAP, 0603	X7R 0402 ok, ROHM MCH182CN104K or equiv.
C5	2.0pF CAP, 0603	NPO, low ESR ATC 600S2R0JW250 or equiv.
C6	1.8pF CAP, 0603	NPO, low ESR ATC 600S1R8CW250 or equiv.
C7	1.5pF CAP, 0603	NPO, low ESR ATC 600S1R5CW250 or equiv.
C8	10pF CAP, 0603	NPO, low EST ATC 600S100JW250 or equiv.
L1	12nH IND, 0805	Coilcraft 0805HQ-12NXJBB.

Application Schematic

(2.5GHz to 2.7GHz)

For $V^+ = V_{CC} = V_{PC} = 5.0V$

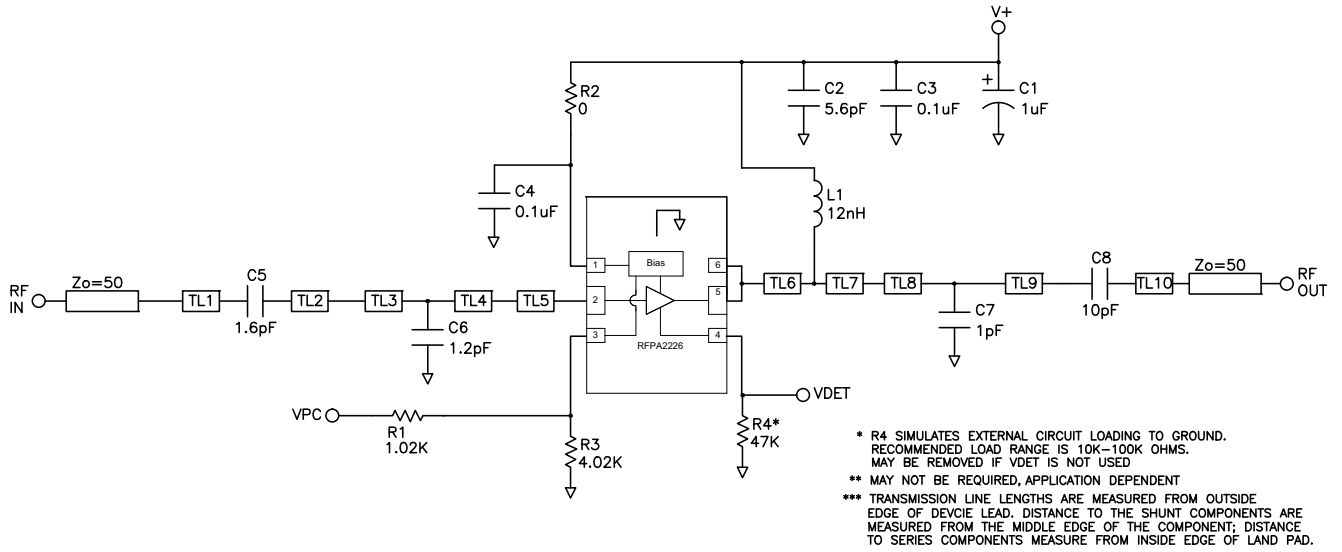

Evaluation Board Layout and Bill of Materials

(2.5GHz to 2.7 GHz)

For $V_+ = V_{CC} = V_{PC} = 5.0V$

Board Material GETEK, 10mil thick, Dk=3.9, 2oz. copper

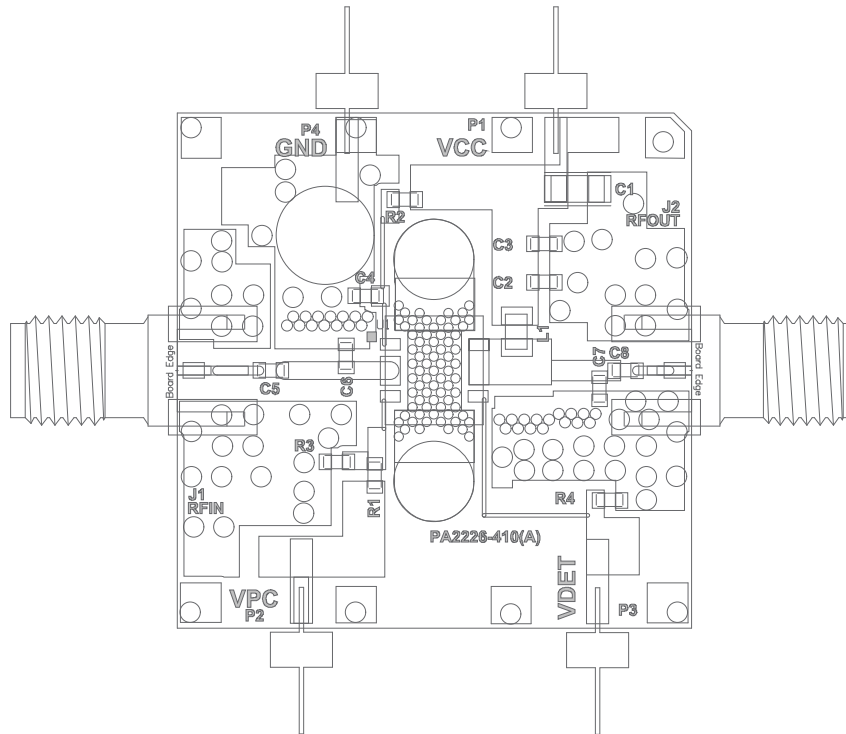

PCB Notes: Do not use less than the recommended number of via holes under the device ground paddle. RF layers thicker than .020 inches (0.5mm) not recommended..

Bill of Materials

(2.5GHz to 2.7 GHz)

DESG	Description	Notes
Q1	RFPA2226	DFN
R1	1.02K, Ω , 0603 1%	0402 may be used
R2	0 Ω , 0603	0402 may be used
R3	4.02K, Ω , 0603 1%	0402 may be used
R4	47K, Ω , 0603	0402 may be used
C1	1uF 16V MLCC CAP	Tantalum ok for EVM performance. Use MLCC type for best IM3 levels.
C2	5.6pF CAP, 0603	NPO ROHM MCH185A5R6DK or equiv.
C3, 4	0.1uF CAP, 0603	X7R 0402 ok, ROHM MCH182CN104K or equiv.
C5	1.6pF CAP, 0603	NPO, low ESR ATC 600S1R6JW250 or equiv.
C6	1.2pF CAP, 0603	NPO, low ESR ATC 600S1R2CW250 or equiv.
C7	1.0pF CAP, 0603	ROHM MCH185A1R0DK or equiv. NPO 0402 ok.
C8	10pF CAP, 0603	NPO, low EST ATC 600S100JW250 or equiv.
L1	12nH IND, 0805	Coilcraft 0805HQ-12NXJBB.

Данный компонент на территории Российской Федерации

Вы можете приобрести в компании MosChip.

Для оперативного оформления запроса Вам необходимо перейти по данной ссылке:

<http://moschip.ru/get-element>

Вы можете разместить у нас заказ для любого Вашего проекта, будь то серийное производство или разработка единичного прибора.

В нашем ассортименте представлены ведущие мировые производители активных и пассивных электронных компонентов.

Нашей специализацией является поставка электронной компонентной базы двойного назначения, продукции таких производителей как XILINX, Intel (ex.ALTERA), Vicor, Microchip, Texas Instruments, Analog Devices, Mini-Circuits, Amphenol, Glenair.

Сотрудничество с глобальными дистрибьюторами электронных компонентов, предоставляет возможность заказывать и получать с международных складов практически любой перечень компонентов в оптимальные для Вас сроки.

На всех этапах разработки и производства наши партнеры могут получить квалифицированную поддержку опытных инженеров.

Система менеджмента качества компании отвечает требованиям в соответствии с ГОСТ Р ИСО 9001, ГОСТ РВ 0015-002 и ЭС РД 009

Офис по работе с юридическими лицами:

105318, г.Москва, ул.Щербаковская д.3, офис 1107, 1118, ДЦ «Щербаковский»

Телефон: +7 495 668-12-70 (многоканальный)

Факс: +7 495 668-12-70 (доб.304)

E-mail: info@moschip.ru

Skype отдела продаж:

moschip.ru

moschip.ru_4

moschip.ru_6

moschip.ru_9