



### FEATURES

- Low input offset voltage: 125  $\mu\text{V}$  (maximum)
- Low input offset voltage drift
  - 0.4  $\mu\text{V}/^\circ\text{C}$  (typical)
  - 2.7  $\mu\text{V}/^\circ\text{C}$  (maximum)
- Ultralow supply current: 500  $\mu\text{A}$  per amplifier
- Fully specified at  $V_s = 3\text{ V}, 5\text{ V}, \pm 5\text{ V}$
- High speed performance
  - 3 dB bandwidth: 105 MHz
  - Slew rate: 160  $\text{V}/\mu\text{s}$
  - Settling time to 0.1%: 35 ns
- Rail-to-rail outputs
- Input common-mode range:  $-V_s - 0.1\text{ V}$  to  $+V_s - 1\text{ V}$
- Low noise: 5.9  $\text{nV}/\sqrt{\text{Hz}}$  at 100 kHz; 0.6  $\text{pA}/\sqrt{\text{Hz}}$  at 100 kHz
- Low distortion: -102 dBc/-126 dBc HD2/HD3 at 100 kHz
- Low input bias current: 470 nA (typical)
- Small packaging
  - 8-lead MSOP

### ENHANCED PRODUCT FEATURES

- Supports defense and aerospace applications (AQEC standard)
- Extended industrial temperature range ( $-55^\circ\text{C}$  to  $+125^\circ\text{C}$ )
- Controlled manufacturing baseline
- 1 assembly/test site
- 1 fabrication site
- Enhanced product change notification
- Qualification data available upon request

### APPLICATIONS

- High resolution, high precision analog-to-digital converter (ADC) drivers
- Battery-powered instrumentation
- Micropower active filters
- Portable point of sales terminals
- Active radio frequency identification (RFID) readers
- Photomultipliers
- ADC reference buffers

### GENERAL DESCRIPTION

The ADA4805-2-EP is a high speed voltage feedback, rail-to-rail output amplifier with an exceptionally low quiescent current of 500  $\mu\text{A}$ , making it ideal for low power, high resolution data conversion systems. Despite being low power, this amplifier provides excellent overall performance. It offers a high bandwidth of 105 MHz at a gain of +1, a high slew rate of 160  $\text{V}/\mu\text{s}$ , and a low input offset voltage of 125  $\mu\text{V}$  (maximum).

### TYPICAL APPLICATIONS CIRCUIT

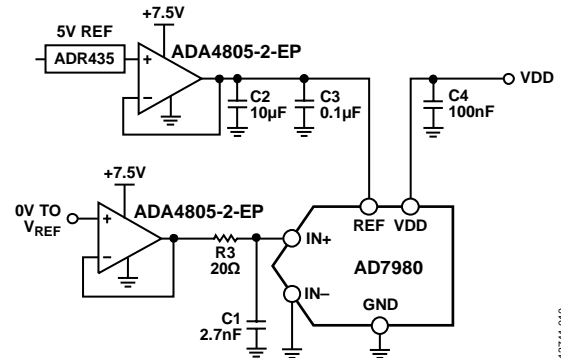

Figure 1. Driving the AD7980 with the ADA4805-2-EP

The Analog Devices, Inc., proprietary extra fast complementary bipolar (XFCB) process allows both low voltage and low current noise (5.9  $\text{nV}/\sqrt{\text{Hz}}$ , 0.6  $\text{pA}/\sqrt{\text{Hz}}$ ). The ADA4805-2-EP operates over a wide range of supply voltages from  $\pm 1.5\text{ V}$  to  $\pm 5\text{ V}$ , as well as single 3 V and 5 V supplies, making it ideal for high speed, low power instruments.

The ADA4805-2-EP is available in an 8-lead MSOP package and is rated to work over the extended industrial temperature range of  $-55^\circ\text{C}$  to  $+125^\circ\text{C}$ . Additional application and technical information can be found in the ADA4805-1/ADA4805-2 data sheet.

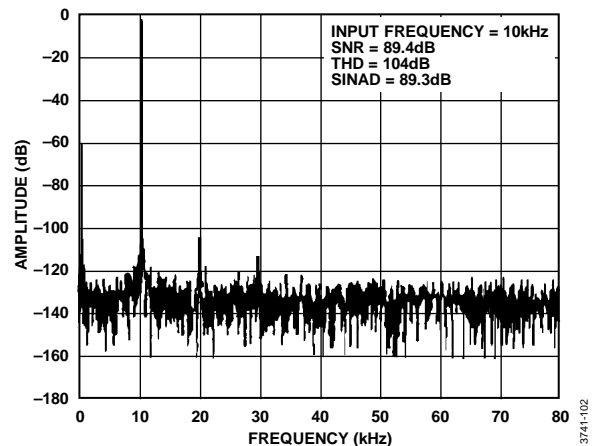

Figure 2. FFT Plot for the Circuit Configuration in Figure 1

Table 1. Complementary ADCs to the ADA4805-2-EP

Product	ADC Power (mW)	Throughput (MSPS)	Resolution (Bits)	SNR (dB)
AD7982	7.0	1	18	98
AD7984	10.5	1.33	18	98.5
AD7980	4.0	1	16	91
AD7685	10	0.25	16	88

**TABLE OF CONTENTS**

Features .....	1	Absolute Maximum Ratings .....	6
Enhanced Product Features .....	1	Thermal Resistance .....	6
Applications .....	1	Maximum Power Dissipation .....	6
General Description .....	1	ESD Caution .....	6
Typical Applications Circuit .....	1	Pin Configuration and Function Descriptions .....	7
Revision History .....	2	Typical Performance Characteristics .....	8
Specifications .....	3	Outline Dimensions .....	9
±5 V Supply .....	3	Ordering Guide .....	9
5 V Supply .....	4		
3 V Supply .....	5		

**REVISION HISTORY**

**4/16—Revision 0: Initial Version**

## SPECIFICATIONS

### ±5 V SUPPLY

$V_S = \pm 5\text{ V}$  at  $T_A = 25^\circ\text{C}$ ;  $R_F = 0\ \Omega$  for  $G = +1$ ; otherwise,  $R_F = 1\ \text{k}\Omega$ ;  $R_L = 2\ \text{k}\Omega$  to ground; unless otherwise noted. All specifications are per amplifier.

Table 2.

Parameter	Test Conditions/Comments	Min	Typ	Max	Unit
<b>DYNAMIC PERFORMANCE</b>					
–3 dB Bandwidth	$G = +1, V_{OUT} = 0.02\text{ V p-p}$		120		MHz
	$G = +1, V_{OUT} = 2\text{ V p-p}$		40		MHz
Bandwidth for 0.1 dB Flatness	$G = +1, V_{OUT} = 0.02\text{ V p-p}$		18		MHz
Slew Rate	$G = +1, V_{OUT} = 2\text{ V step}$		190		V/ $\mu\text{s}$
	$G = +2, V_{OUT} = 4\text{ V step}$		250		V/ $\mu\text{s}$
Settling Time to 0.1%	$G = +1, V_{OUT} = 2\text{ V step}$		35		ns
	$G = +2, V_{OUT} = 4\text{ V step}$		78		ns
<b>NOISE/DISTORTION PERFORMANCE</b>					
Harmonic Distortion, HD <sub>2</sub> /HD <sub>3</sub> <sup>1</sup>	$f_C = 20\ \text{kHz}, V_{OUT} = 2\text{ V p-p}$		–114/–140		dBc
	$f_C = 100\ \text{kHz}, V_{OUT} = 2\text{ V p-p}$		–102/–128		dBc
	$f_C = 20\ \text{kHz}, V_{OUT} = 4\text{ V p-p}, G = +1$		–109/–143		dBc
	$f_C = 100\ \text{kHz}, V_{OUT} = 4\text{ V p-p}, G = +1$		–93/–130		dBc
	$f_C = 20\ \text{kHz}, V_{OUT} = 4\text{ V p-p}, G = +2$		–113/–142		dBc
	$f_C = 100\ \text{kHz}, V_{OUT} = 4\text{ V p-p}, G = +2$		–96/–130		dBc
Input Voltage Noise	$f = 100\ \text{kHz}$		5.2		nV/ $\sqrt{\text{Hz}}$
Input Voltage Noise 1/f Corner Frequency			8		Hz
0.1 Hz to 10 Hz Voltage Noise			44		nV rms
Input Current Noise	$f = 100\ \text{kHz}$		0.7		pA/ $\sqrt{\text{Hz}}$
<b>DC PERFORMANCE</b>					
Input Offset Voltage			13	125	$\mu\text{V}$
Input Offset Voltage Drift <sup>2</sup>	$T_{MIN}$ to $T_{MAX}$		0.4	2.7	$\mu\text{V}/^\circ\text{C}$
Input Bias Current			550	800	nA
Input Offset Current			2.1	25	nA
Open-Loop Gain	$V_{OUT} = -4.0\text{ V to }+4.0\text{ V}$	107	111		dB
<b>INPUT CHARACTERISTICS</b>					
Input Resistance					
Common Mode			50		M $\Omega$
Differential Mode			260		k $\Omega$
Input Capacitance			1		pF
Input Common-Mode Voltage Range		–5.1		+4	V
Common-Mode Rejection Ratio	$V_{IN, CM} = -4.0\text{ V to }+4.0\text{ V}$	103	130		dB
<b>OUTPUT CHARACTERISTICS</b>					
Output Overdrive Recovery Time (Rising/Falling Edge)	$V_{IN} = +6\text{ V to }-6\text{ V}, G = +2$		95/100		ns
Output Voltage Swing	$R_L = 2\ \text{k}\Omega$	–4.98		+4.98	V
Short-Circuit Current	Sinking/sourcing		85/73		mA
Linear Output Current	<1% THD at 100 kHz, $V_{OUT} = 2\text{ V p-p}$		±58		mA
Capacitive Load Drive	30% overshoot		15		pF
<b>POWER SUPPLY</b>					
Operating Range		2.7		10	V
Quiescent Current per Amplifier			570	625	$\mu\text{A}$
Power Supply Rejection Ratio					
Positive	$+V_S = 3\text{ V to }5\text{ V}, -V_S = -5\text{ V}$	100	119		dB
Negative	$+V_S = 5\text{ V}, -V_S = -3\text{ V to }-5\text{ V}$	100	122		dB

<sup>1</sup>  $f_C$  is the fundamental frequency.

<sup>2</sup> Guaranteed, but not tested.

**5 V SUPPLY**

$V_S = 5\text{ V}$  at  $T_A = 25^\circ\text{C}$ ;  $R_F = 0\ \Omega$  for  $G = +1$ ; otherwise,  $R_F = 1\ \text{k}\Omega$ ;  $R_L = 2\ \text{k}\Omega$  to midsupply; unless otherwise noted. All specifications are per amplifier.

**Table 3.**

Parameter	Test Conditions/Comments	Min	Typ	Max	Unit
<b>DYNAMIC PERFORMANCE</b>					
-3 dB Bandwidth	$G = +1, V_{OUT} = 0.02\text{ V p-p}$		105		MHz
	$G = +1, V_{OUT} = 2\text{ V p-p}$		35		MHz
Bandwidth for 0.1 dB Flatness	$G = +1, V_{OUT} = 0.02\text{ V p-p}$		20		MHz
Slew Rate	$G = +1, V_{OUT} = 2\text{ V step}$		160		V/ $\mu\text{s}$
	$G = +2, V_{OUT} = 4\text{ V step}$		220		V/ $\mu\text{s}$
Settling Time to 0.1%	$G = +1, V_{OUT} = 2\text{ V step}$		35		ns
	$G = +2, V_{OUT} = 4\text{ V step}$		82		ns
<b>NOISE/DISTORTION PERFORMANCE</b>					
Harmonic Distortion, HD2/HD3 <sup>1</sup>	$f_C = 20\ \text{kHz}, V_{OUT} = 2\text{ V p-p}$		-114/-135		dBc
	$f_C = 100\ \text{kHz}, V_{OUT} = 2\text{ V p-p}$		-102/-126		dBc
	$f_C = 20\ \text{kHz}, G = +2, V_{OUT} = 4\text{ V p-p}$		-107/-143		dBc
	$f_C = 100\ \text{kHz}, G = +2, V_{OUT} = 4\text{ V p-p}$		-90/-130		dBc
Input Voltage Noise	$f = 100\ \text{kHz}$		5.9		nV/ $\sqrt{\text{Hz}}$
Input Voltage Noise 1/f Corner			8		Hz
0.1 Hz to 10 Hz Voltage Noise			54		nV rms
Input Current Noise	$f = 100\ \text{kHz}$		0.6		pA/ $\sqrt{\text{Hz}}$
<b>DC PERFORMANCE</b>					
Input Offset Voltage			9	125	$\mu\text{V}$
Input Offset Voltage Drift <sup>2</sup>	$T_{MIN}$ to $T_{MAX}$		0.4	2.7	$\mu\text{V}/^\circ\text{C}$
Input Bias Current			470	720	nA
Input Offset Current			0.4		nA
Open-Loop Gain	$V_{OUT} = 1.25\text{ V to }3.75\text{ V}$	105	109		dB
<b>INPUT CHARACTERISTICS</b>					
Input Resistance			50		M $\Omega$
Common Mode			260		k $\Omega$
Differential Mode			1		pF
Input Capacitance					
Input Common-Mode Voltage Range		-0.1		+4	V
Common-Mode Rejection Ratio	$V_{IN,CM} = 1.25\text{ V to }3.75\text{ V}$	103	133		dB
<b>OUTPUT CHARACTERISTICS</b>					
Overdrive Recovery Time (Rising/Falling Edge)	$V_{IN} = -1\text{ V to }+6\text{ V}, G = +2$		130/145		ns
Output Voltage Swing	$R_L = 2\ \text{k}\Omega$	0.02		4.98	V
Short-Circuit Current	Sinking/sourcing		73/63		mA
Linear Output Current	<1% THD at 100 kHz, $V_{OUT} = 2\text{ V p-p}$		$\pm 47$		mA
Capacitive Load Drive	30% overshoot		15		pF
<b>POWER SUPPLY</b>					
Operating Range		2.7		10	V
Quiescent Current per Amplifier			500	520	$\mu\text{A}$
Power Supply Rejection Ratio					
Positive	$+V_S = 1.5\text{ V to }3.5\text{ V}, -V_S = -2.5\text{ V}$	100	120		dB
Negative	$+V_S = 2.5\text{ V}, -V_S = -1.5\text{ V to }-3.5\text{ V}$	100	126		dB

<sup>1</sup>  $f_C$  is the fundamental frequency.

<sup>2</sup> Guaranteed, but not tested.

**3 V SUPPLY**

$V_S = 3\text{ V}$  at  $T_A = 25^\circ\text{C}$ ;  $R_F = 0\ \Omega$  for  $G = +1$ ; otherwise,  $R_F = 1\ \text{k}\Omega$ ;  $R_L = 2\ \text{k}\Omega$  to midsupply; unless otherwise noted. All specifications are per amplifier.

**Table 4.**

Parameter	Test Conditions/Comments	Min	Typ	Max	Unit
<b>DYNAMIC PERFORMANCE</b>					
-3 dB Bandwidth	$G = +1, V_{OUT} = 0.02\text{ V p-p}$		95		MHz
	$G = +1, V_{OUT} = 1\text{ V p-p}, +V_S = 2\text{ V}, -V_S = -1\text{ V}$		30		MHz
Bandwidth for 0.1 dB Flatness	$G = +1, V_{OUT} = 0.02\text{ V p-p}$		35		MHz
Slew Rate	$G = +1, V_{OUT} = 1\text{ V step}, +V_S = 2\text{ V}, -V_S = -1\text{ V}$		85		V/ $\mu\text{s}$
Settling Time to 0.1%	$G = +1, V_{OUT} = 1\text{ V step}$		41		ns
<b>NOISE/DISTORTION PERFORMANCE</b>					
Harmonic Distortion, HD2/HD3 <sup>1</sup>	$f_c = 20\ \text{kHz}, V_{OUT} = 1\text{ V p-p}, +V_S = 2\text{ V}, -V_S = -1\text{ V}$		-123/-143		dBc
	$f_c = 100\ \text{kHz}, V_{OUT} = 1\text{ V p-p}, +V_S = 2\text{ V}, -V_S = -1\text{ V}$		-107/-133		dBc
Input Voltage Noise	$f = 100\ \text{kHz}$		6.3		nV/ $\sqrt{\text{Hz}}$
Input Voltage Noise 1/f Corner			8		Hz
0.1 Hz to 10 Hz Voltage Noise			55		nV rms
Input Current Noise	$f = 100\ \text{kHz}$		0.8		pA/ $\sqrt{\text{Hz}}$
<b>DC PERFORMANCE</b>					
Input Offset Voltage			7	125	$\mu\text{V}$
Input Offset Voltage Drift <sup>2</sup>	$T_{MIN}$ to $T_{MAX}$		0.4	2.7	$\mu\text{V}/^\circ\text{C}$
Input Bias Current			440	690	nA
Input Offset Current			0.5		nA
Open-Loop Gain	$V_{OUT} = 1.1\text{ V to }1.9\text{ V}$	100	107		dB
<b>INPUT CHARACTERISTICS</b>					
Input Resistance			50		M $\Omega$
Common Mode			260		k $\Omega$
Differential Mode			1		pF
Input Capacitance					
Input Common-Mode Voltage Range		-0.1		+2	V
Common-Mode Rejection Ratio	$V_{IN,CM} = 0.5\text{ V to }2\text{ V}$	89	117		dB
<b>OUTPUT CHARACTERISTICS</b>					
Output Overdrive Recovery Time (Rising/Falling Edge)	$V_{IN} = -1\text{ V to }+4\text{ V}, G = +2$		135/175		ns
Output Voltage Swing	$R_L = 2\ \text{k}\Omega$	0.02		2.98	V
Short-Circuit Current	Sinking/sourcing		65/47		mA
Linear Output Current	<1% THD at 100 kHz, $V_{OUT} = 1\text{ V p-p}$		$\pm 40$		mA
Capacitive Load Drive	30% overshoot		15		pF
<b>POWER SUPPLY</b>					
Operating Range		2.7		10	V
Quiescent Current per Amplifier			470	495	$\mu\text{A}$
Power Supply Rejection Ratio					
Positive	$+V_S = 1.5\text{ V to }3.5\text{ V}, -V_S = -1.5\text{ V}$	96	119		dB
Negative	$+V_S = 1.5\text{ V}, -V_S = -1.5\text{ V to }-3.5\text{ V}$	96	125		dB

<sup>1</sup>  $f_c$  is the fundamental frequency.

<sup>2</sup> Guaranteed, but not tested.

## ABSOLUTE MAXIMUM RATINGS

Table 5.

Parameter	Rating
Supply Voltage	11 V
Power Dissipation	See Figure 3
Common-Mode Input Voltage	-V <sub>S</sub> - 0.7 V to +V <sub>S</sub> + 0.7 V
Differential Input Voltage	±1 V
Storage Temperature Range	-65°C to +125°C
Operating Temperature Range	-55°C to +125°C
Lead Temperature (Soldering, 10 sec)	300°C
Junction Temperature	150°C

Stresses at or above those listed under Absolute Maximum Ratings may cause permanent damage to the product. This is a stress rating only; functional operation of the product at these or any other conditions above those indicated in the operational section of this specification is not implied. Operation beyond the maximum operating conditions for extended periods may affect product reliability.

### THERMAL RESISTANCE

θ<sub>JA</sub> is specified for the worst case conditions, that is, θ<sub>JA</sub> is specified for a device soldered in a circuit board for surface-mount packages. Table 6 lists the θ<sub>JA</sub> for the ADA4805-2-EP.

Table 6. Thermal Resistance

Package Type	θ <sub>JA</sub>	Unit
8-Lead MSOP	123.8	°C/W

### MAXIMUM POWER DISSIPATION

The maximum safe power dissipation for the ADA4805-2-EP is limited by the associated rise in junction temperature (T<sub>J</sub>) on the die. At approximately 150°C, which is the glass transition temperature, the properties of the plastic change. Even temporarily exceeding this temperature limit may change the stresses that the package exerts on the die, permanently shifting the parametric performance of the ADA4805-2-EP. Exceeding a junction temperature of 175°C for an extended period of time can result in changes in silicon devices, potentially causing degradation or loss of functionality.

The power dissipated in the package (P<sub>D</sub>) is the sum of the quiescent power dissipation and the power dissipated in the die due to the ADA4805-2-EP output load drive.

The quiescent power dissipation is the voltage between the supply pins (V<sub>S</sub>) multiplied by the quiescent current (I<sub>S</sub>).

$$P_D = \text{Quiescent Power} + (\text{Total Drive Power} - \text{Load Power})$$

$$P_D = (V_S \times I_S) + \left( \frac{V_S}{2} \times \frac{V_{OUT}}{R_L} \right) - \frac{V_{OUT}^2}{R_L}$$

RMS output voltages must be considered. If R<sub>L</sub> is referenced to -V<sub>S</sub>, as in single-supply operation, the total drive power is V<sub>S</sub> × I<sub>OUT</sub>. If the rms signal levels are indeterminate, consider the worst case, when V<sub>OUT</sub> = V<sub>S</sub>/4 for R<sub>L</sub> to midsupply.

$$P_D = (V_S \times I_S) + \frac{(V_S / 4)^2}{R_L}$$

In single-supply operation with R<sub>L</sub> referenced to -V<sub>S</sub>, worst case is V<sub>OUT</sub> = V<sub>S</sub>/2.

Airflow increases heat dissipation, effectively reducing θ<sub>JA</sub>. Also, more metal directly in contact with the package leads and exposed pad from metal traces, through holes, ground, and power planes reduces θ<sub>JA</sub>.

Figure 3 shows the maximum safe power dissipation in the package vs. the ambient temperature on a JEDEC standard, 4-layer board. θ<sub>JA</sub> values are approximations.

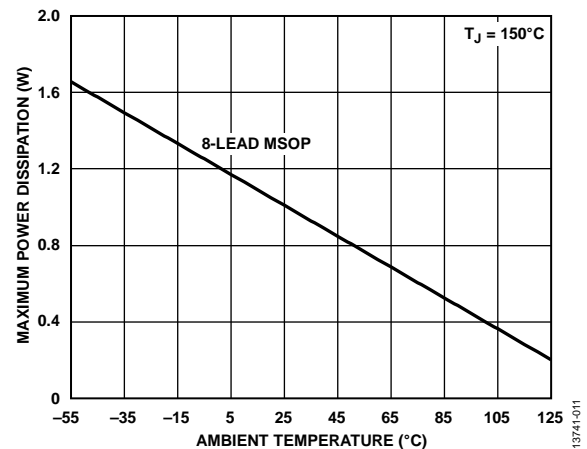

Figure 3. Maximum Power Dissipation vs. Temperature for a 4-Layer Board

### ESD CAUTION



**ESD (electrostatic discharge) sensitive device.** Charged devices and circuit boards can discharge without detection. Although this product features patented or proprietary protection circuitry, damage may occur on devices subjected to high energy ESD. Therefore, proper ESD precautions should be taken to avoid performance degradation or loss of functionality.

## PIN CONFIGURATION AND FUNCTION DESCRIPTIONS

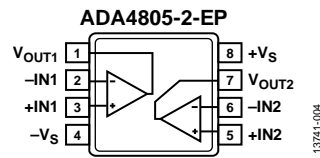

Figure 4. 8-Lead MSOP Pin Configuration

Table 7. Pin Function Descriptions

Pin No.	Mnemonic	Description
1	$V_{OUT1}$	Output 1.
2	$-IN1$	Inverting Input 1.
3	$+IN1$	Noninverting Input 1.
4	$-V_S$	Negative Supply.
5	$+IN2$	Noninverting Input 2.
6	$-IN2$	Inverting Input 2.
7	$V_{OUT2}$	Output 2.
8	$+V_S$	Positive Supply.

# TYPICAL PERFORMANCE CHARACTERISTICS

$R_L = 2\text{ k}\Omega$ , unless otherwise noted. When  $G = +1$ ,  $R_F = 0\ \Omega$ .

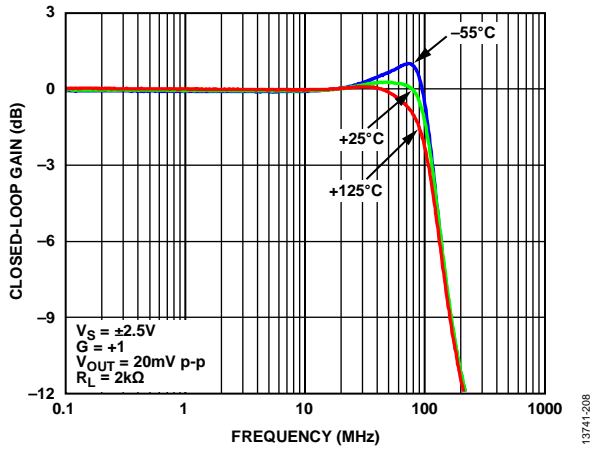

Figure 5. Small Signal Frequency Response for Various Temperatures

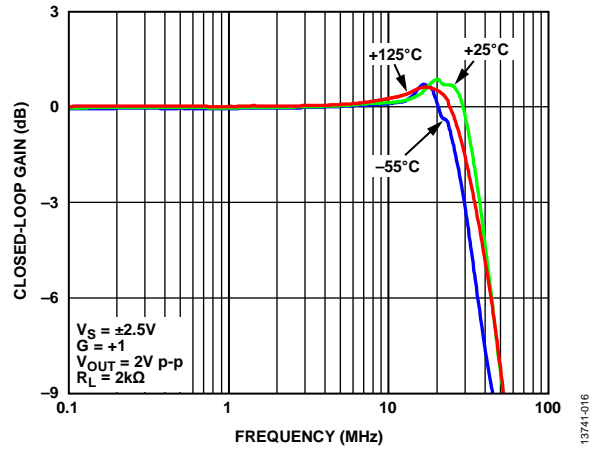

Figure 8. Large Signal Frequency Response for Various Temperatures

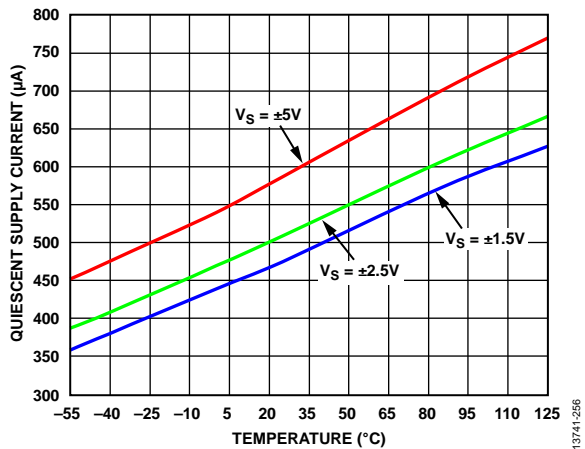

Figure 6. Quiescent Supply Current vs. Temperature for Various Supplies

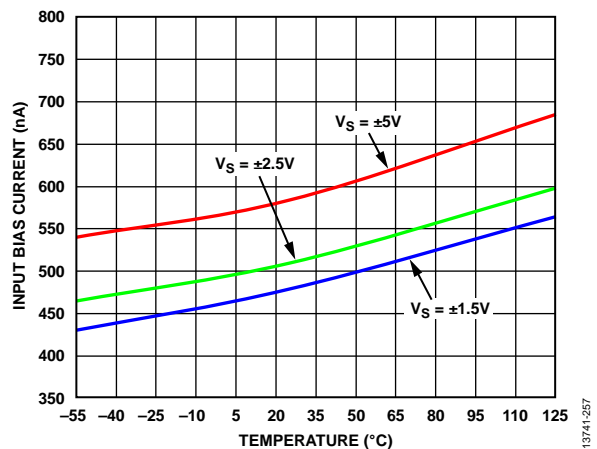

Figure 9. Input Bias Current vs. Temperature for Various Supplies

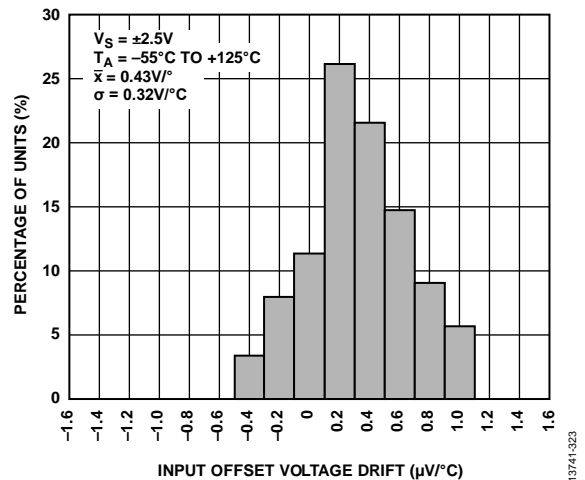

Figure 7. Input Offset Voltage Drift Distribution

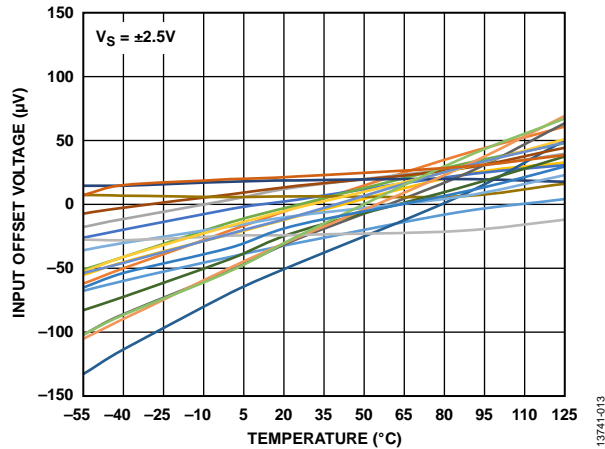
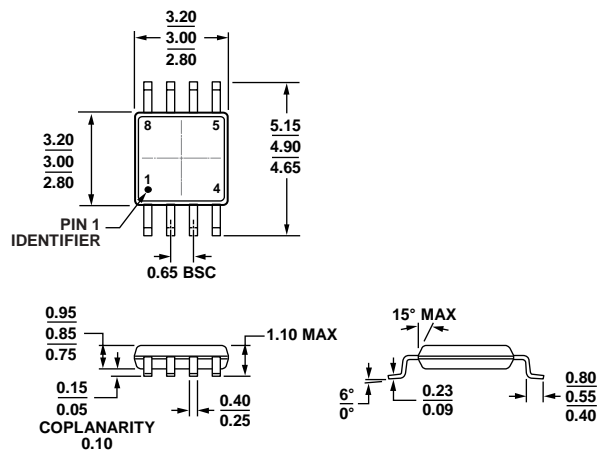

Figure 10. Input Offset Voltage vs. Temperature



# OUTLINE DIMENSIONS



COMPLIANT TO JEDEC STANDARDS MO-187-AA

Figure 11. 8-Lead Mini Small Outline Package [MSOP] (RM-8)

Dimensions shown in millimeters

10-07-2009-B

## ORDERING GUIDE

Model <sup>1</sup>	Temperature Range	Package Description	Package Option	Branding
ADA4805-2TRMZ-EP	-55°C to +125°C	8-Lead Mini Small Outline Package [MSOP]	RM-8	Y5W
ADA4805-2TRMZ-EPR7	-55°C to +125°C	8-Lead Mini Small Outline Package [MSOP]	RM-8	Y5W

<sup>1</sup> Z = RoHS Compliant Part.

## Данный компонент на территории Российской Федерации

### Вы можете приобрести в компании MosChip.

Для оперативного оформления запроса Вам необходимо перейти по данной ссылке:

<http://moschip.ru/get-element>

Вы можете разместить у нас заказ для любого Вашего проекта, будь то серийное производство или разработка единичного прибора.

В нашем ассортименте представлены ведущие мировые производители активных и пассивных электронных компонентов.

Нашей специализацией является поставка электронной компонентной базы двойного назначения, продукции таких производителей как XILINX, Intel (ex.ALTERA), Vicor, Microchip, Texas Instruments, Analog Devices, Mini-Circuits, Amphenol, Glenair.

Сотрудничество с глобальными дистрибьюторами электронных компонентов, предоставляет возможность заказывать и получать с международных складов практически любой перечень компонентов в оптимальные для Вас сроки.

На всех этапах разработки и производства наши партнеры могут получить квалифицированную поддержку опытных инженеров.

Система менеджмента качества компании отвечает требованиям в соответствии с ГОСТ Р ИСО 9001, ГОСТ РВ 0015-002 и ЭС РД 009

### Офис по работе с юридическими лицами:

105318, г.Москва, ул.Щербаковская д.3, офис 1107, 1118, ДЦ «Щербаковский»

Телефон: +7 495 668-12-70 (многоканальный)

Факс: +7 495 668-12-70 (доб.304)

E-mail: [info@moschip.ru](mailto:info@moschip.ru)

Skype отдела продаж:

moschip.ru

moschip.ru\_4

moschip.ru\_6

moschip.ru\_9