



3D SURROUND AUDIO PROCESSOR FOR HEADPHONE

■ GENERAL DESCRIPTION

The **NJM2703** is a high quality 3D surround audio processor designed for headphone applications.

It includes mode control switch (Surround mode / Bypass mode).

The **NJM2703** features low operating voltage, low operating current, low output noise and very small package, and is suitable for any portable audio applications.

■ PACKAGE OUTLINE



NJM2703RB2
(MSOP10 (TVSP10))

■ FEATURES

- Operating Voltage 1.8 to 6V
- Low Operating Current 0.45mA typ. (at Surround mode, VR: max.)
- Low Output Noise 10 μ V typ. (at Surround mode, VR: max.)
- Variable Surround Effect by external resistor
- Internal Mode Control Switch
- Bipolar Technology
- Package Outline MSOP10 (TVSP10)*

*MEET JEDEC MO-187-DA / THIN TYPE

■ PIN CONFIGURATION

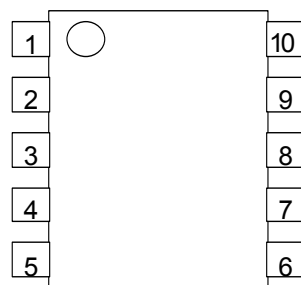

1. LIN
2. RIN
3. SW
4. VREF
5. GND
6. V+
7. NFR
8. NFL
9. ROUT
10. LOUT

■ BLOCK DIAGRAM

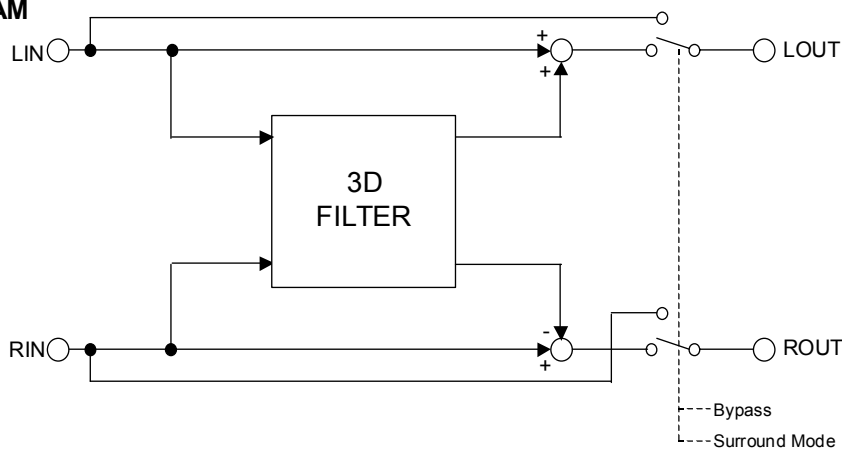

NJM2703

■ABSOLUTE MAXIMUM RATING (Ta=25°C)

PARAMETER	SYMBOL	RATINGS	UNIT
Supply Voltage	V ⁺	7	V
Power Dissipation	P _D	320	mW
Operating Temperature Range	T _{opr}	-20 to +75	°C
Storage Temperature Range	T _{stg}	-40 to +125	°C

■OPERATING VOLTAGE

PARAMETER	SYMBOL	TEST CONDITION	MIN.	TYP.	MAX.	UNIT
Operating Voltage	V ⁺	-	1.8	3.0	6.0	V

■ELECTRICAL CHARACTERISTICS (V⁺=3V, Ta=25°C unless otherwise specified)

PARAMETER	SYMBOL	TEST CONDITION						MIN.	TYP.	MAX.	UNIT
		INPUT		OUTPUT	MODE	VR					
		L	R								
Operating Current	I _{cc}	No Signal	0	0	-	Bypass	-	-	0.45	0.7	mA
			0	0	-	Surround	MAX	-	0.45	0.7	
Reference Voltage	V _{ref}	No Signal	0	0	-	-	-	1.0	1.15	1.3	V

● AC CHARACTERISTICS

(V⁺=3V, Ta=25°C, V_{IN}=-20dBV(100mVrms), f=1kHz, R_L=10kΩ, unless otherwise specified)

PARAMETER	SYMBOL	TEST CONDITION						MIN.	TYP.	MAX.	UNIT
		INPUT		OUTPUT	MODE	VR					
		L	R								
Maximum Input Voltage	V _{IM}	f=1kHz T.H.D.=1%	V _{IN} 0	0 V _{IN}	L R	Bypass	-	-	-2.0 (790)	-	dBV (mVrms)
		f=100Hz T.H.D.=1%	V _{IN} 0	0 V _{IN}	L R	Surround	MAX	-	-16.0 (160)	-	
		V ⁺ =1.8V f=1kHz T.H.D.=1%	V _{IN} 0	0 V _{IN}	L R	Bypass	-	-10.5 (300)	-8.5 (380)	-	
		V ⁺ =1.8V f=100Hz T.H.D.=1%	V _{IN} 0	0 V _{IN}	L R	Surround	MAX	-24.5 (60)	-22.5 (75)	-	
Output Noise	V _{NO}	R _g =0Ω A-Weighted	0	0	L R	Bypass	-	-	-112 (2.5)	-106 (5.0)	dBV (μVrms)
		R _g =0Ω A-Weighted	0	0	L R	Surround	MAX	-	-100 (10)	-94 (20)	
Total Harmonic Distortion	T.H.D.	f=1kHz	V _{IN} 0	0 V _{IN}	L R	Bypass	-	-	0.02	0.05	%
		f=1kHz	V _{IN} 0	0 V _{IN}	L R	Surround	MAX	-	0.1	0.5	

● **AC CHARACTERISTICS**

($V_+ = 3V$, $T_a = 25^\circ C$, $V_{IN} = -20dBV(100mV_{rms})$, $f = 1kHz$, $R_L = 10k\Omega$, unless otherwise specified)

PARAMETER	SYMBOL	TEST CONDITION						MIN.	TYP.	MAX.	UNIT
		INPUT		OUTPUT	MODE	VR					
		L	R								
Bypass Gain	G_{VBYP}	$f = 1kHz$	V_{IN} 0	0 V_{IN}	L R	Bypass	-	-1.0	0.0	1.0	dB
Surround Gain	G_{VSUR}	$f = 100Hz$	V_{IN} 0	0 V_{IN}	L R	Surround	MAX	12.5	14.5	16.5	dB
		$f = 100Hz$	0 V_{IN}	V_{IN} 0	L R	Surround	MAX	10.5	12.5	14.5	
		$f = 100Hz$	V_{IN} 0	0 V_{IN}	L R	Surround	MIN	0.5	2.5	4.5	

● **CONTROL CHARACTERISTICS** ($V_+ = 3V$, $T_a = 25^\circ C$ unless otherwise specified)

PARAMETER	SYMBOL	TEST CONDITION						MIN.	TYP.	MAX.	UNIT
		INPUT		OUTPUT	MODE	VR					
		L	R								
Mode Select Control Voltage	V_{MODE}	$V_{IN} =$ High Level	-	-	-	-	-	1.2	-	V_+	V
		$V_{IN} =$ Low Level	-	-	-	-	-	0.0	-	0.3	

■ **MODE SWITCH**

MODE	SW	NOTES
Bypass	L, open	Input Through
Surround	H	Surround Mode (Stereo Input)

NJM2703

■ TERMINAL DESCRIPTION

PIN NO.	SYMBOL	FUNCTION	EQUIVALENT CIRCUIT	VOLTAGE
1 2	LIN RIN	Rch Input Lch Input		1.15V
3	SW	Mode control switch		0V
4	VREF	Reference voltage		1.15V
5	GND	GND		0V

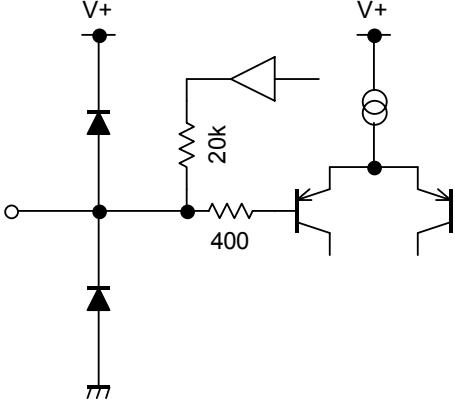
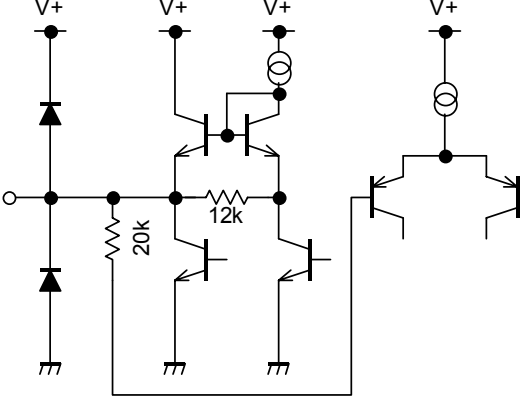
PIN NO.	SYMBOL	FUNCTION	EQUIVALENT CIRCUIT	VOLTAGE
5	V+	Power Supply		V+
7 8	NFL NFR	Filter terminal Filter terminal		1.15V
9 10	ROUT LOUT	Rch Output Lch Output		1.15V

NJM2703

■ APPLICATION CIRCUIT

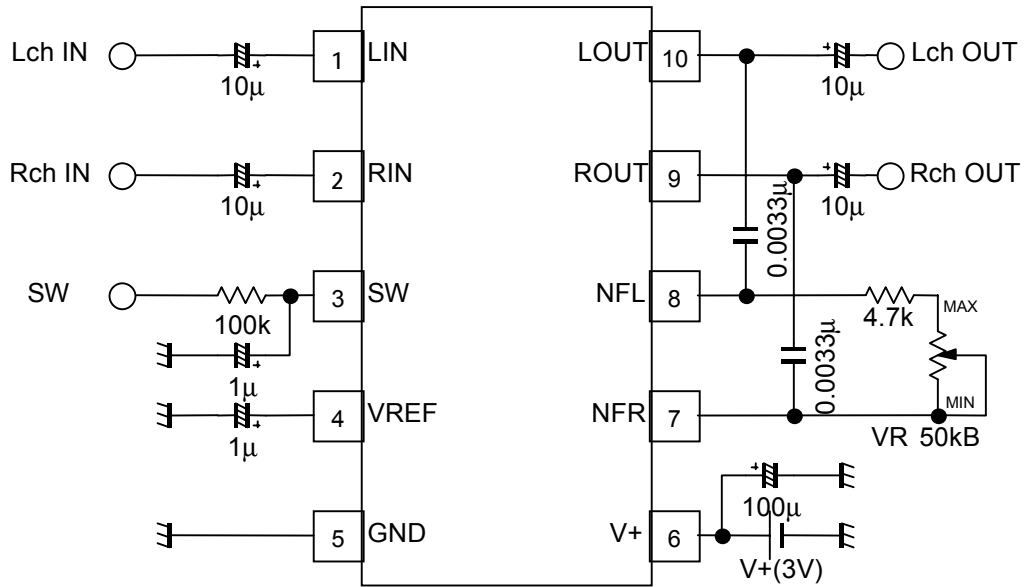

■ TYPICAL CHARACTERISTICS

Supply Current vs. Supply Voltage

Ta=25degrees

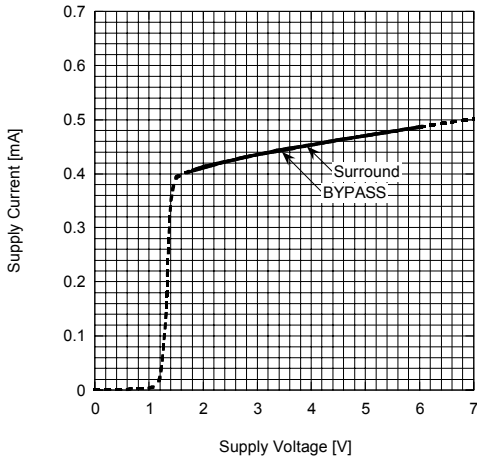

Supply Current vs. Ambient Temperature

V+=3V

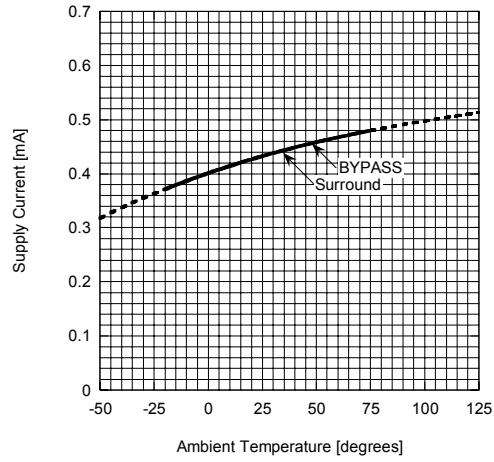

Reference Voltage vs. Supply Voltage

Ta=25degrees

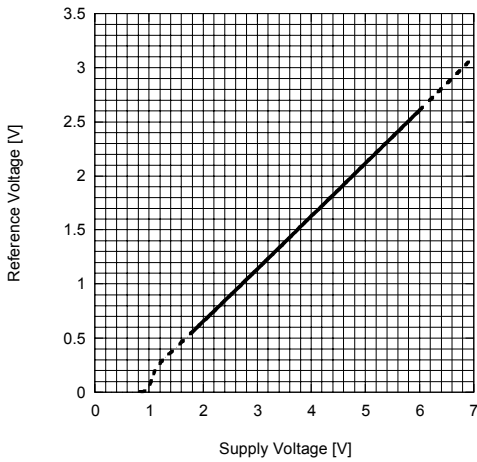

Reference Voltage vs. Ambient Temperature

V+=3V

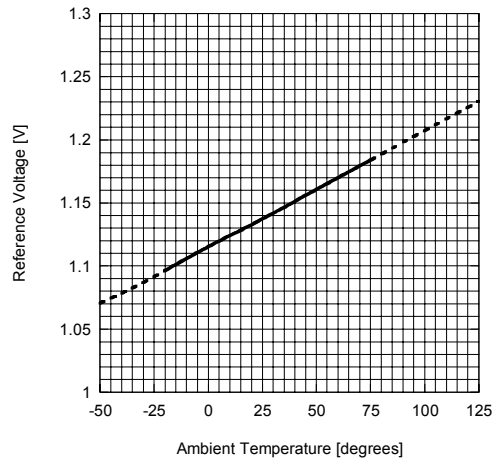

Maximum Input Voltage vs. Supply Voltage (BYPASS)

Vin=Lch f=1kHz Vout=Lch RL=10kohm
THD=1% Ta=25degrees

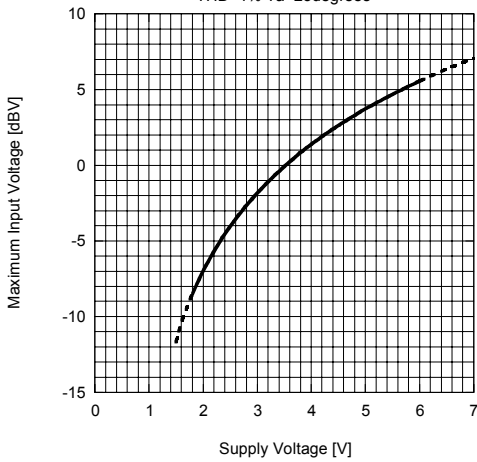

Maximum Input Voltage vs. Supply Voltage (Surround)

Vin=Lch f=100Hz Vout=Lch RL=10kohm VR=MAX
THD=1% Ta=25degrees

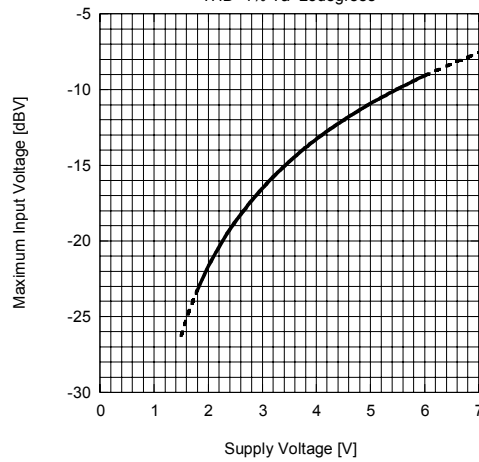

TYPICAL CHARACTERISTICS

Maximum Input Voltage vs. Ambient Temperature (BYPASS)

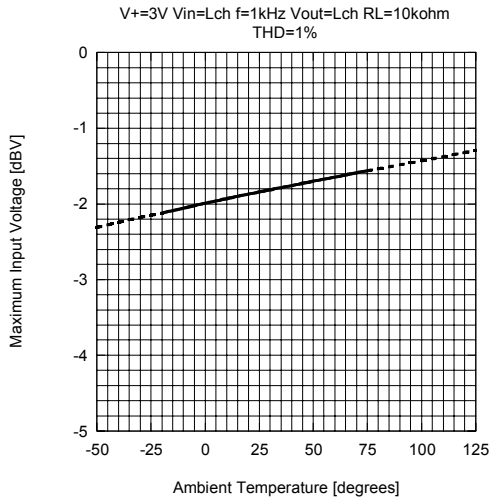

Maximum Input Voltage vs. Ambient Temperature (Surround)

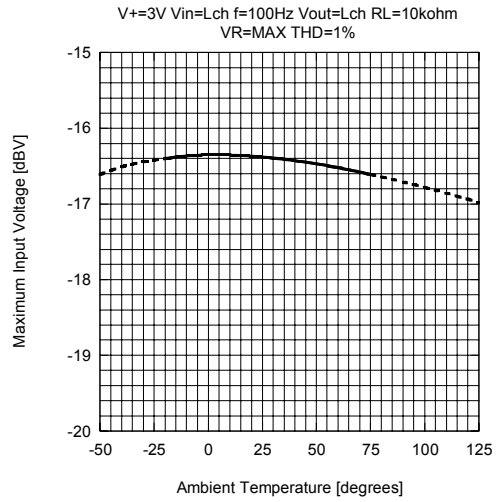

Maximum Input Voltage vs. Ambient Temperature (BYPASS)

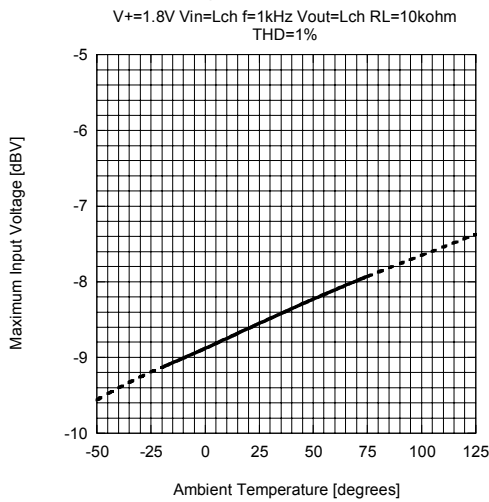

Maximum Input Voltage vs. Ambient Temperature (Surround)

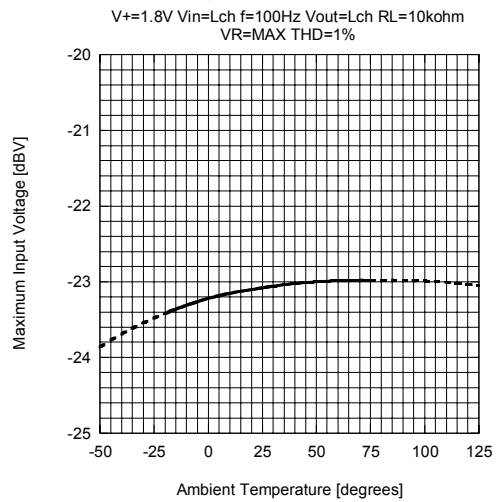

Output Noise Voltage vs. Ambient Temperature

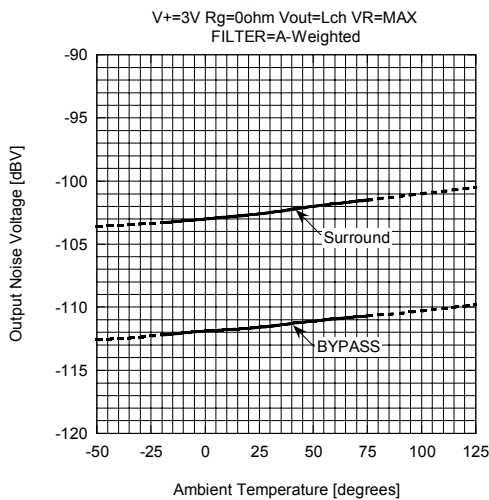

Output Noise Voltage vs. Ambient Temperature

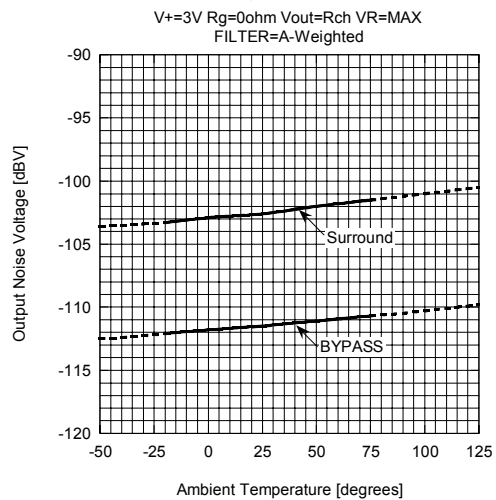

TYPICAL CHARACTERISTICS

Total Harmonic Distortion vs. Input Voltage (BYPASS)

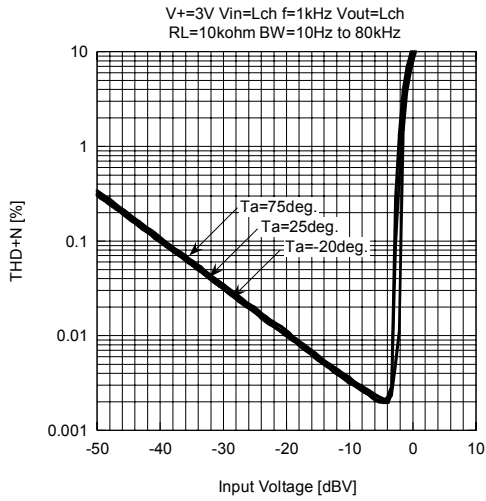

Total Harmonic Distortion vs. Input Voltage (Surround)

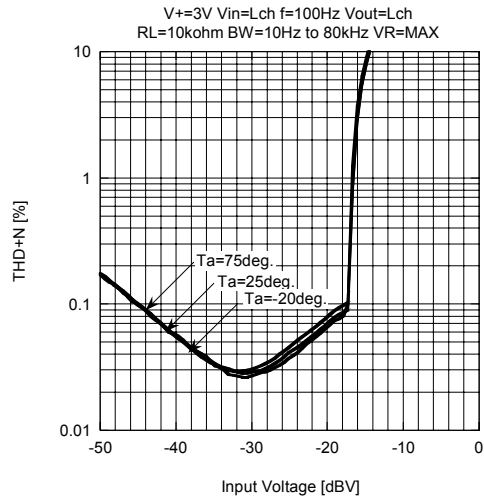

Voltage Gain vs. Frequency (BYPASS)

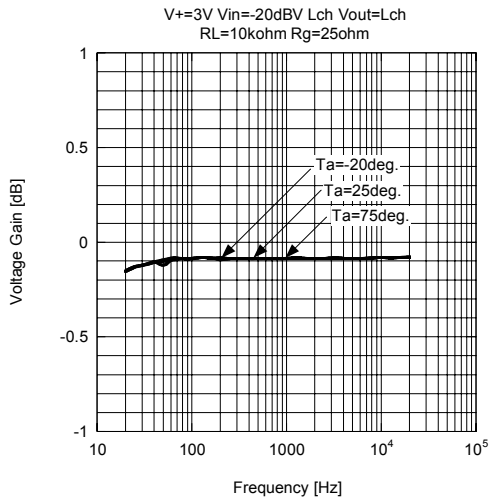

Voltage Gain vs. Frequency (Surround)

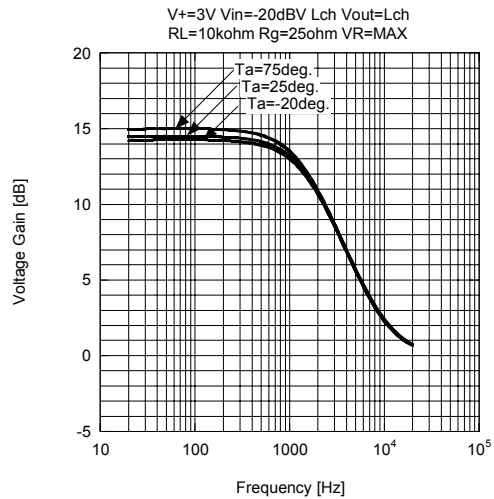

Voltage Gain vs. Frequency (Surround)

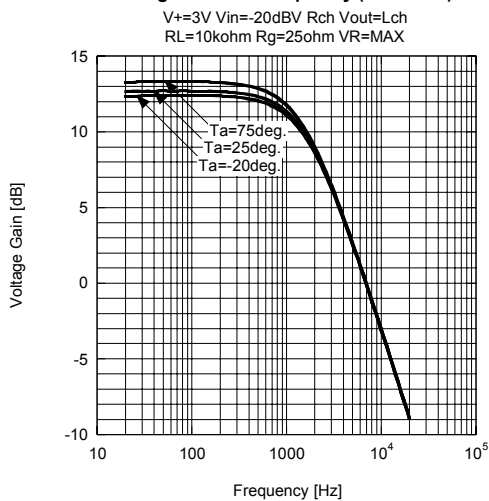

Voltage Gain vs. Frequency (Surround)

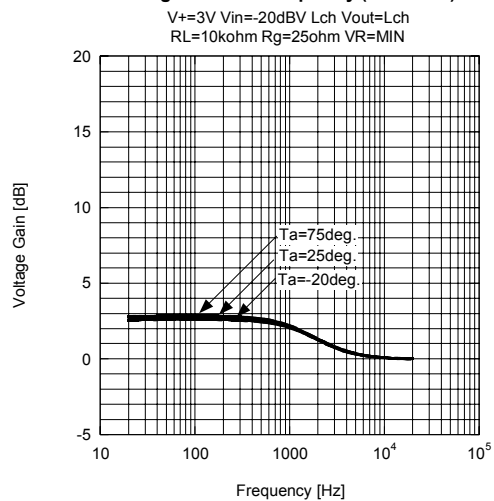

NJM2703

■ TYPICAL CHARACTERISTICS

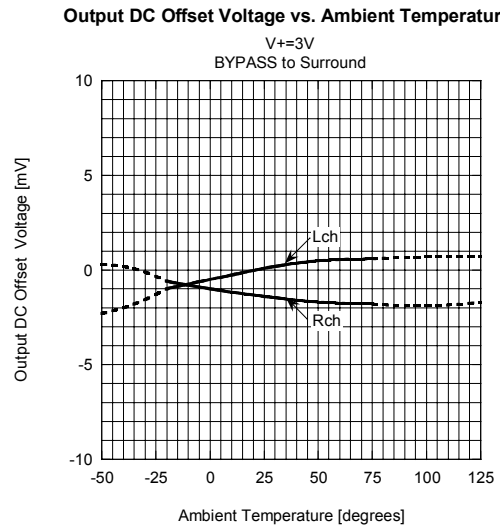
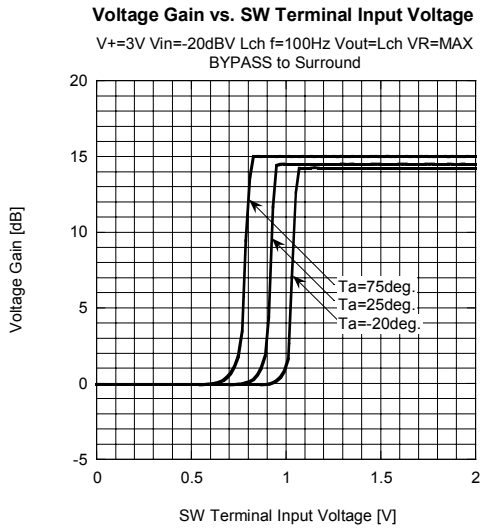

[CAUTION]

The specifications on this databook are only given for information, without any guarantee as regards either mistakes or omissions. The application circuits in this databook are described only to show representative usages of the product and not intended for the guarantee or permission of any right including the industrial rights.

Mouser Electronics

Authorized Distributor

Click to View Pricing, Inventory, Delivery & Lifecycle Information:

[NJR:](#)

[NJM2703RB2-TE1](#)

Данный компонент на территории Российской Федерации

Вы можете приобрести в компании MosChip.

Для оперативного оформления запроса Вам необходимо перейти по данной ссылке:

<http://moschip.ru/get-element>

Вы можете разместить у нас заказ для любого Вашего проекта, будь то серийное производство или разработка единичного прибора.

В нашем ассортименте представлены ведущие мировые производители активных и пассивных электронных компонентов.

Нашей специализацией является поставка электронной компонентной базы двойного назначения, продукции таких производителей как XILINX, Intel (ex.ALTERA), Vicor, Microchip, Texas Instruments, Analog Devices, Mini-Circuits, Amphenol, Glenair.

Сотрудничество с глобальными дистрибьюторами электронных компонентов, предоставляет возможность заказывать и получать с международных складов практически любой перечень компонентов в оптимальные для Вас сроки.

На всех этапах разработки и производства наши партнеры могут получить квалифицированную поддержку опытных инженеров.

Система менеджмента качества компании отвечает требованиям в соответствии с ГОСТ Р ИСО 9001, ГОСТ РВ 0015-002 и ЭС РД 009

Офис по работе с юридическими лицами:

105318, г.Москва, ул.Щербаковская д.3, офис 1107, 1118, ДЦ «Щербаковский»

Телефон: +7 495 668-12-70 (многоканальный)

Факс: +7 495 668-12-70 (доб.304)

E-mail: info@moschip.ru

Skype отдела продаж:

moschip.ru

moschip.ru_4

moschip.ru_6

moschip.ru_9