

A02 series

Keylock & selector switches

Distinctive features and specifications

A028_AX1607US



- ❑ Panel Sealed to IP65
- ❑ Single pole to four pole
- ❑ Custom engraving & overmould key
- ❑ Captive screw & push on tab terminals
- ❑ 12A 250VAC

ELECTRICAL SPECIFICATIONS

- **Current/Voltage Rating** : 25mA 5VAC Min, 12A 250VAC, 16A 250VAC max
12A 12VDC max
- **Initial Contact Resistance** : 10mΩ max at 1A 4VDC
- **Insulation Resistance** : 50MΩ min
- **Dielectric Strength** : 2KV between open contacts, 4KV live to accessible
- **Electrical Life** : 50,000 cycles min
- **Contact Gap** : Double break 2 x 1,5mm (0.059)
- **Insulation** : Class 2

MECHANICAL SPECIFICATIONS

- **Mechanical Life (operator)** : Momentary, 1 million cycles, maintained 100,000 cycles
- **Lamp** : Midget grove T1 ¾ filament, neon or LED
- **Terminals** : M3 captive screw and push on tab terminal

GENERAL SPECIFICATIONS

- **Operating Temperature** : -20°C to +85°C
- **Sealing** : Panel sealed to IP65, rear of panel IP40

AGENCY APPROVALS



PANEL CUT OUT

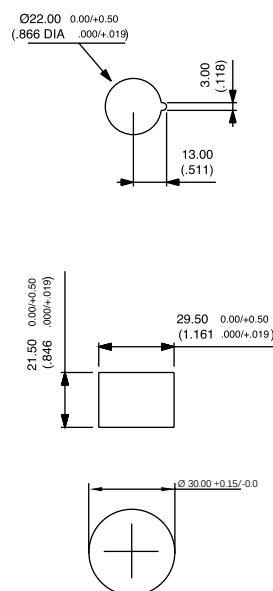

MATERIALS

- **Key** : Nickel plated steel
- **Key Barrel** : Chrome plated alloy
- **Optional Metal Bezel** : Nickel plated brass
- **Operator** : PBT
- **Nut** : ABS
- **Camtrack Momentary** : PPE
- **Camtrack Maintained** : PPSU
- **Switch Block 1 & 2 Pole** : PBT
- **Switch Block 3 & 4 Pole** : PEI
- **Contacts** : Gold plated silver



Dimensions : first dimensions are in mm while inches are shown in brackets.
Refer to the following pages for further information.



Mounting accessories : standard hardware 1 nut and 1 sealing washer.

A02 series

Keylock & selector switches

Panel cut-out $\text{Ø}22\text{mm}$ (0.866) or 29.5 (1.161) x 21.5(0.846)mm

Keylock

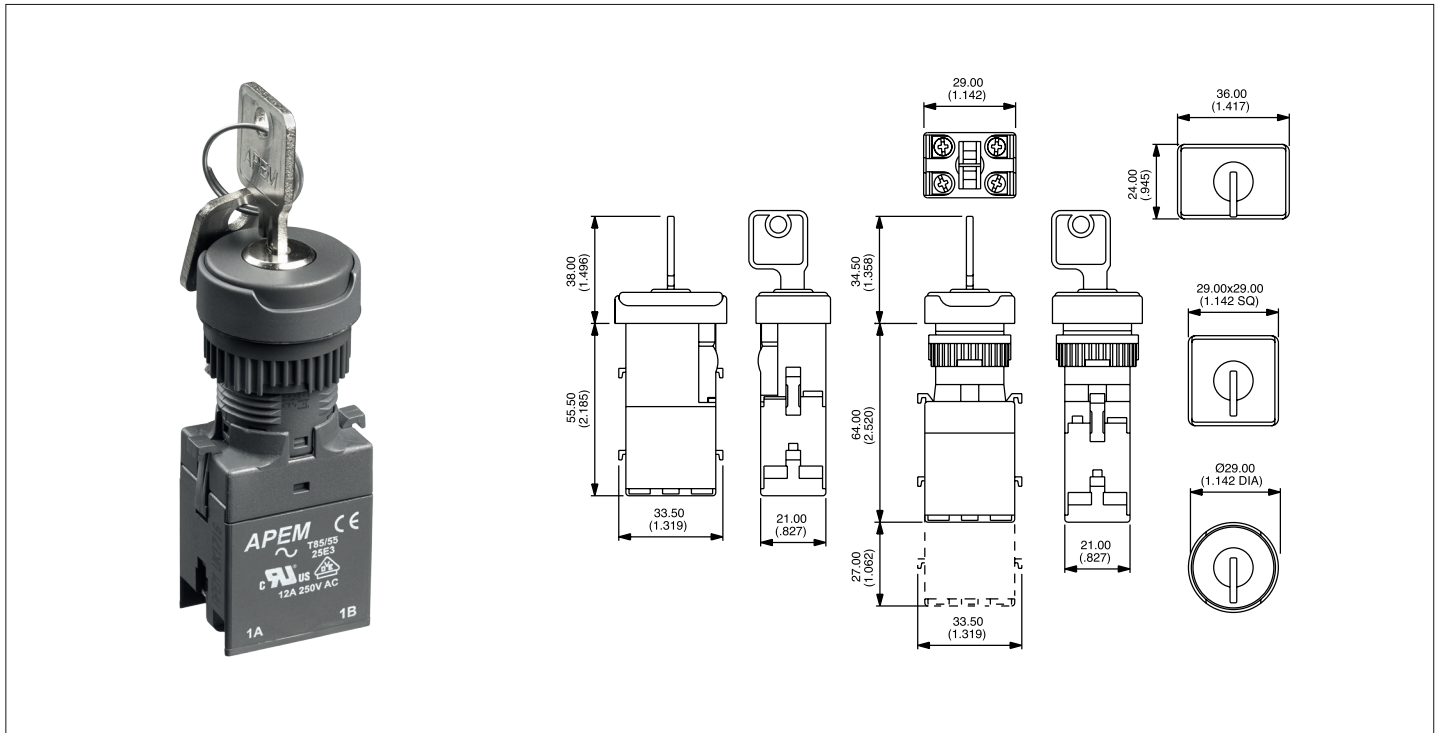

Selector

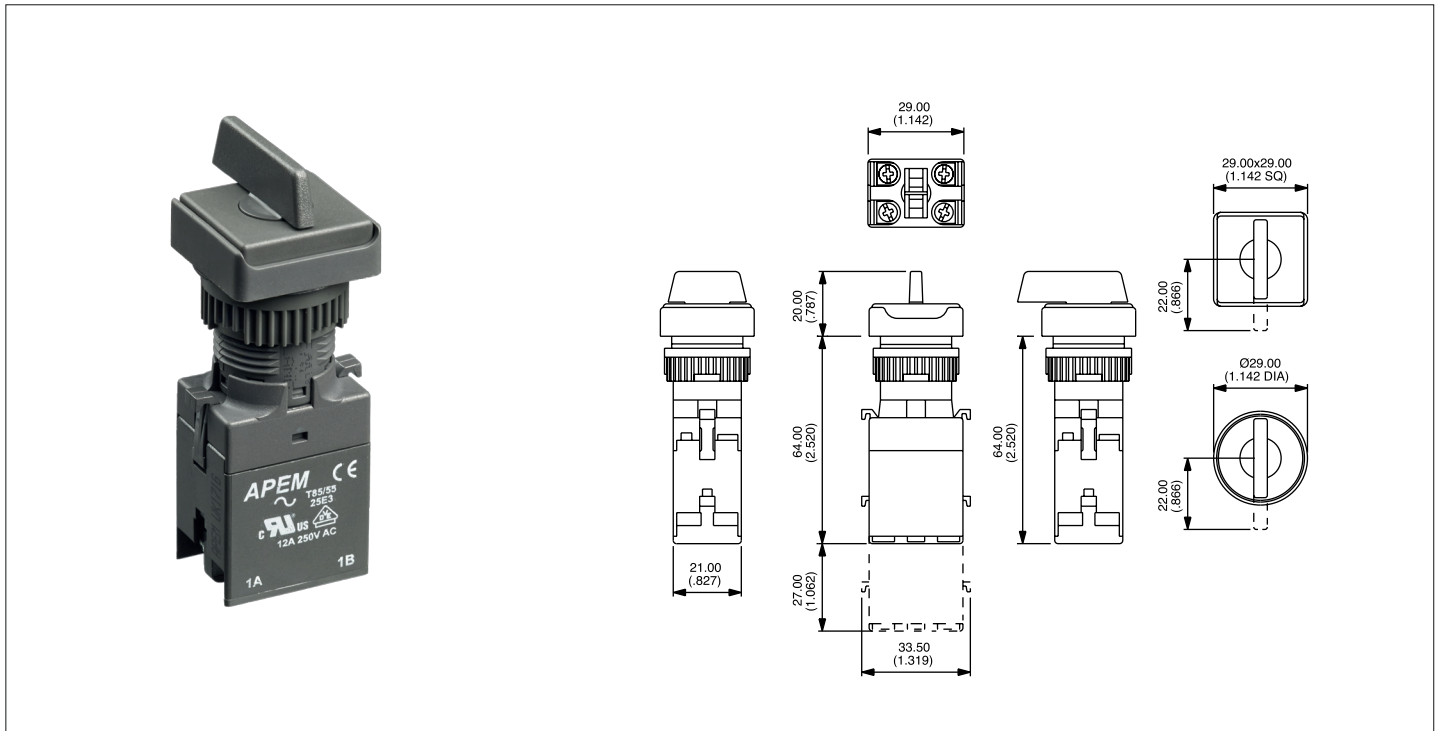

A02 series

Keylock & selector switches

Overview

Keylock

Operator		+ Switch block			
Bezel	Description	Part No.	Key removable in positions	Contacts	Part No
<input type="checkbox"/>	2 pos. maintained	A028101	A-C	1 N.O.	A02501
<input type="checkbox"/>	2 pos. momentary	A028102	A	1 N.C.	A02502
<input type="checkbox"/>	3 pos. maintained	A028105	A-B-C	2 N.O.	A02503
<input type="checkbox"/>	3 pos. momentary	A028106	A	2 N.C.	A02504
<input type="checkbox"/>	3 pos. mainL, momR	A028107	A	1 N.O./1 N.C.	A02505
<input type="checkbox"/>	3 pos. momL, mainR	A028108	A-B		
<input type="checkbox"/>	3 pos. momL, mainR	A028108	A-C		
<input type="checkbox"/>	2 pos. maintained	A028201	A-C		
<input type="checkbox"/>	2 pos. momentary	A028202	A		
<input type="checkbox"/>	3 pos. maintained	A028205	A-B-C		
<input type="checkbox"/>	3 pos. momentary	A028206	A		
<input type="checkbox"/>	3 pos. mainL, momR	A028207	A-B		
<input type="checkbox"/>	3 pos. momL, mainR	A028208	A-C		
<input type="checkbox"/>	3 pos. momL, mainR	A028208	A-C		
<input type="checkbox"/>	2 pos. maintained	A028301	A-C	1 N.O.	A02506
<input type="checkbox"/>	2 pos. momentary	A028302	A	1 N.C.	A02507
<input type="checkbox"/>	3 pos. maintained	A028305	A-B-C	2 N.O.	A02508
<input type="checkbox"/>	3 pos. momentary	A028306	A	2 N.C.	A02509
<input type="checkbox"/>	3 pos. mainL, momR	A028307	A-B	1 N.O./1 N.C.	A02510
<input type="checkbox"/>	3 pos. momL, mainR	A028308	A-C		

Second switch block	
Contacts	Part No
1 N.O.	A02506
1 N.C.	A02507
2 N.O.	A02508
2 N.C.	A02509
1 N.O./1 N.C.	A02510

To achieve 3 or 4 pole switching, add second switch block from above table.

Key Rotation – 2 position switches

The model numbers shown are for switches with anticlockwise lever rotation.

For clockwise rotation, replace:

01 with **20**
02 with **19**

at the end of the model number

- 2 standard keys are supplied
- 20 key barrel types available from stock
- Non-removable key positions: contact APEM components

Bezel: rectangular square round. 'pos' - position, 'mainL' - maintained left 'momR' - momentary right, etc

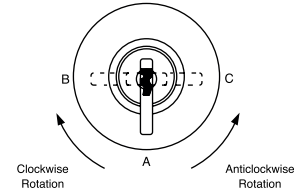

Selector

Operator		+ Switch block			
Bezel	Description	Short lever	Long lever	Contacts	Part No
<input type="checkbox"/>	2 pos. maintained	A029201	A029101	1 N.O.	A02501
<input type="checkbox"/>	2 pos. momentary	A029202	A029102	1 N.C.	A02502
<input type="checkbox"/>	3 pos. maintained	A029203	A029103	2 N.O.	A02503
<input type="checkbox"/>	3 pos. momentary	A029204	A029104	2 N.C.	A02504
<input type="checkbox"/>	3 pos. mainL, momR	A029205	A029105	1 N.O./1 N.C.	A02505
<input type="checkbox"/>	3 pos. momL, mainR	A029206	A029106		
<input type="checkbox"/>	2 pos. maintained	A029401	A029301		
<input type="checkbox"/>	2 pos. momentary	A029402	A029302		
<input type="checkbox"/>	3 pos. maintained	A029403	A029303		
<input type="checkbox"/>	3 pos. momentary	A029404	A029304		
<input type="checkbox"/>	3 pos. mainL, momR	A029405	A029305		
<input type="checkbox"/>	3 pos. momL, mainR	A029406	A029306		

Second switch block	
Contacts	Part No
1 N.O.	A02506
1 N.C.	A02507
2 N.O.	A02508
2 N.C.	A02509
1 N.O./1 N.C.	A02510

To achieve 3 or 4 pole switching, add second switch block from above table.

Lever Rotation – 2 position switches

The model numbers shown are for switches with anticlockwise lever rotation.

For clockwise rotation, replace:

01 with **07**
02 with **08**

at the end of the model number

Optional engraving on lever end add "WL" to the end of the part number.

Bezel: square round

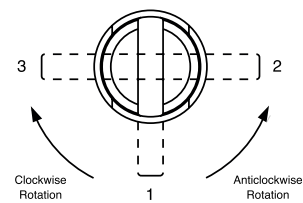

Unsealed switches & indicators (IP40) suffix 01 to the end of the part number.
 Screen engraving insertable legends, & bi-color LED's please contact APEM
 For 6.35mm push on tab terminals suffix the switch block part number with SP

A02 series Keylock & selector switches

Installation & tools

Installation guide

PANEL MOUNTING ASSEMBLY

- Drill/punch hole shaped as shown on page one.
- Assemble front operator through hole and
 - a) Round & square types, tighten nut to a maximum torque of 0.8Nm using tool no. 30-0001. Snap on the adaptor block fit fixing nut and tighten to a maximum
 - b) Rectangular types, tighten the two panel fixing screws in the front to a maximum torque of 6cNm
- Wire chosen switch block as required and snap onto back of operator with optional end cap
- Fit bulb if required using tool No. 30-0002.
- Snap screen onto reflector assembly with legend in between if required and snap onto front operator, take care to line up the locating slot with the polarising dot and not to damage the internal seal
- To place/remove the bulb use the bulb extractor 30-0002.

SWITCH BLOCK ASSEMBLY

The switch block snaps onto the adaptor block, to remove, lever out the latches using a small screwdriver taking care not to overbend, pull off the block from the adaptor block.

Tools

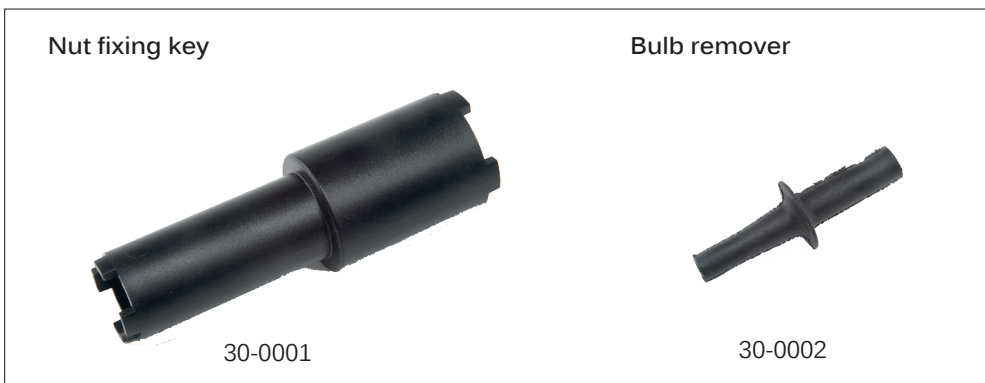

Accessories

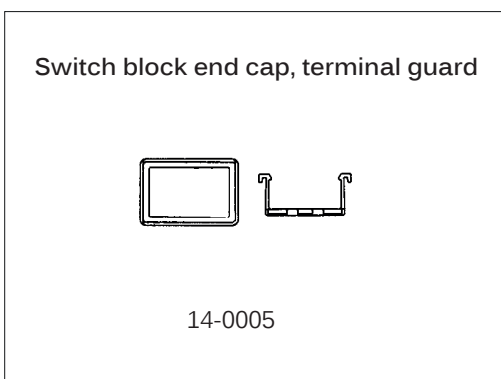

Данный компонент на территории Российской Федерации

Вы можете приобрести в компании MosChip.

Для оперативного оформления запроса Вам необходимо перейти по данной ссылке:

<http://moschip.ru/get-element>

Вы можете разместить у нас заказ для любого Вашего проекта, будь то серийное производство или разработка единичного прибора.

В нашем ассортименте представлены ведущие мировые производители активных и пассивных электронных компонентов.

Нашей специализацией является поставка электронной компонентной базы двойного назначения, продукции таких производителей как XILINX, Intel (ex.ALTERA), Vicor, Microchip, Texas Instruments, Analog Devices, Mini-Circuits, Amphenol, Glenair.

Сотрудничество с глобальными дистрибьюторами электронных компонентов, предоставляет возможность заказывать и получать с международных складов практически любой перечень компонентов в оптимальные для Вас сроки.

На всех этапах разработки и производства наши партнеры могут получить квалифицированную поддержку опытных инженеров.

Система менеджмента качества компании отвечает требованиям в соответствии с ГОСТ Р ИСО 9001, ГОСТ РВ 0015-002 и ЭС РД 009

Офис по работе с юридическими лицами:

105318, г.Москва, ул.Щербаковская д.3, офис 1107, 1118, ДЦ «Щербаковский»

Телефон: +7 495 668-12-70 (многоканальный)

Факс: +7 495 668-12-70 (доб.304)

E-mail: info@moschip.ru

Skype отдела продаж:

moschip.ru

moschip.ru_4

moschip.ru_6

moschip.ru_9