

## Class R Fuseblocks Catalog Data

Catalog Number	Covers		Voltage	Current	Number of Poles	Label
	Class R	w/o Indication				
RM25100-1CR	CVR-RH-25100	CVRI-RH-25100	250	100	1	RM25100-1CR
RM25100-2CR					2	RM25100-2CR
RM25100-3CR					3	RM25100-3CR
RM25200-1CR	CVR-RH-25200	CVRI-RH-25200		200	1	RM25200-1CR
RM25200-2CR					2	RM25200-2CR
RM25200-3CR					3	RM25200-3CR
RM25400-1CR	CVR-RH-25400	CVRI-RH-25400		400	1	RM25400-1CR
RM25400-2CR					2	RM25400-2CR
RM25400-3CR					3	RM25400-3CR
RM25600-1CR	CVR-RH-25600	CVRI-RH-25600		600	1	RM25600-1CR
RM25600-2CR					2	RM25600-2CR
RM25600-3CR					3	RM25600-3CR

Catalog Number	Covers		Voltage	Current	Number of Poles	Label
	Class R	w/o Indication				
RM60100-1CR	CVR-RH-60100	CVRI-RH-60100	600	100	1	RM60100-1CR
RM60100-2CR					2	RM60100-2CR
RM60100-3CR					3	RM60100-3CR
RM60200-1CR	CVR-RH-60200	CVRI-RH-60200		200	1	RM60200-1CR
RM60200-2CR					2	RM60200-2CR
RM60200-3CR					3	RM60200-3CR
RM60400-1CR	CVR-RH-60400	CVRI-RH-60400		400	1	RM60400-1CR
RM60400-2CR					2	RM60400-2CR
RM60400-3CR					3	RM60400-3CR
RM60600-1CR	CVR-RH-60600	CVRI-RH-60600		600	1	RM60600-1CR
RM60600-2CR					2	RM60600-2CR
RM60600-3CR					3	RM60600-3CR

**COOPER Bussmann**  
St. Louis MO 63178

TITLE:

**Class R fuse holder-CUST**

SCALE: 1:1

SIZE: A3

SHEET: 1 OF 14



PUSH DOWN



LIFT UP

LIFT UP, THEN ROTATE OVER



**COOPER Bussmann**  
St. Louis MO 63178

TITLE:  
**Class R fuse holder-CUST**

SCALE: 1:2      SIZE: A3      SHEET: 2 OF 14

www.Bussmann.com

**RM25100-1CR**

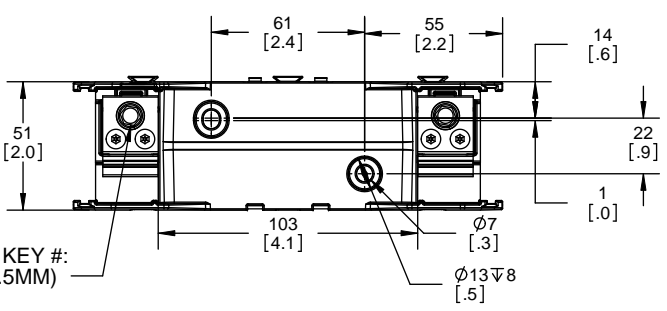

**RM25100-1CR WITH CVR-RH-25100 INSTALLED**

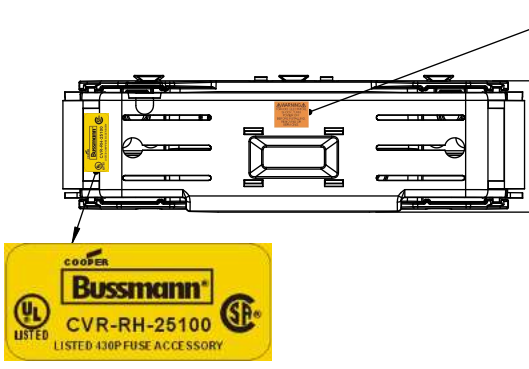

**RM25100-1CR WITH CVRI-RH-25100 INSTALLED**

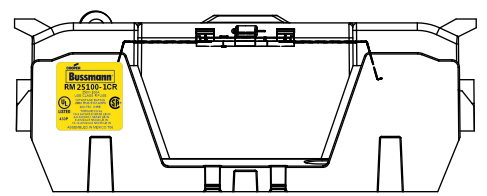
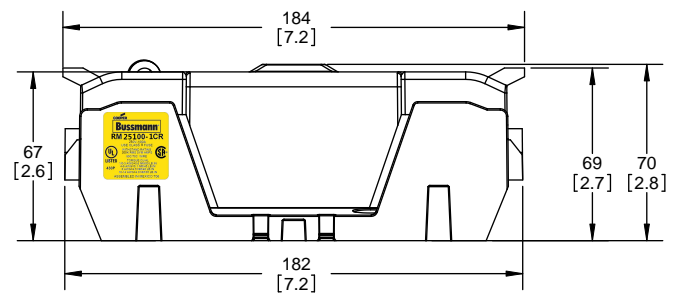
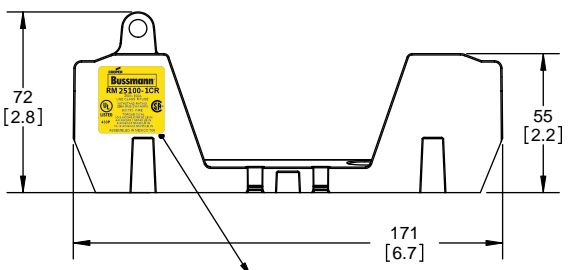
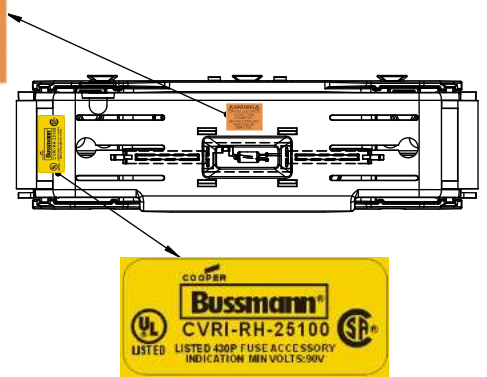

**CVR-RH-25100**

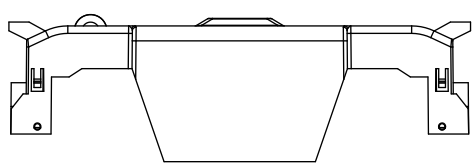

**CVRI-RH-25100**

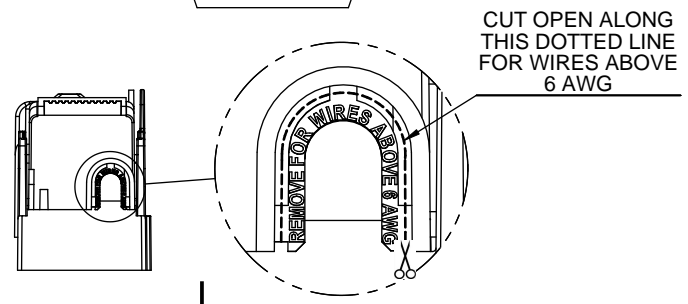
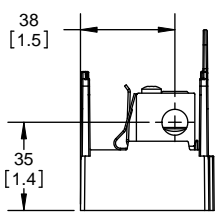
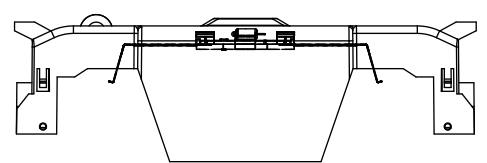

**COOPER Bussmann**  
St. Louis MO 63178

TITLE: **Class R fuse holder-CUST-250V**

SCALE: 1:1 SIZE: A3 SHEET: 3 OF 14

DESIGN UNITS: METRIC (mm)  
UNLESS OTHERWISE SPECIFIED  
[INCHES]

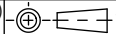

THIRD ANGLE PROJECTION

**RM25100-2CR**



**RM25100-2CR  
WITH CVR-RH-25100 INSTALLED**



**RM25100-2CR  
WITH CVRI-RH-25100 INSTALLED**

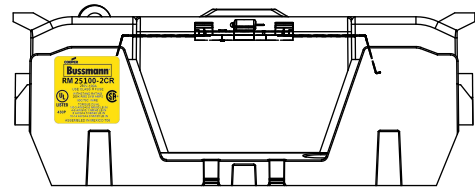
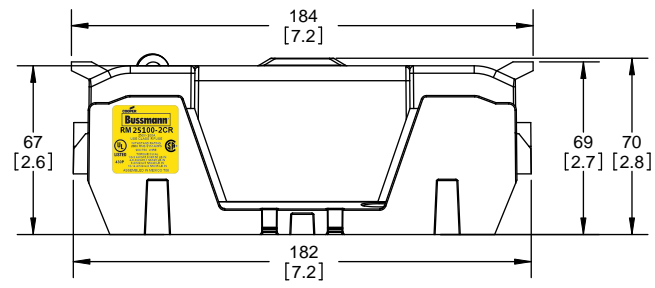
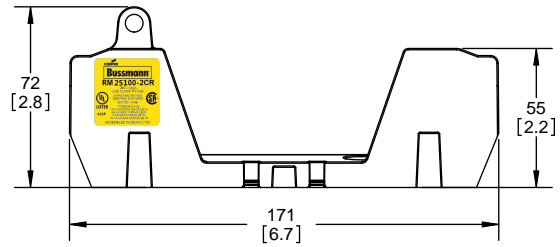
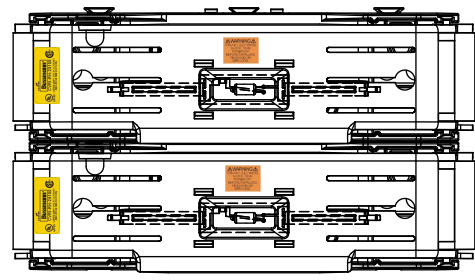

**COOPER Bussmann**  
St. Louis MO 63178

TITLE:  
**Class R fuse holder-CUST-250V**

SCALE: 1:1      SIZE: A3      SHEET: 4 OF 14

DESIGN UNITS: METRIC (mm)  
UNLESS OTHERWISE SPECIFIED [INCHES]



THIRD ANGLE PROJECTION

**RM25100-3CR**

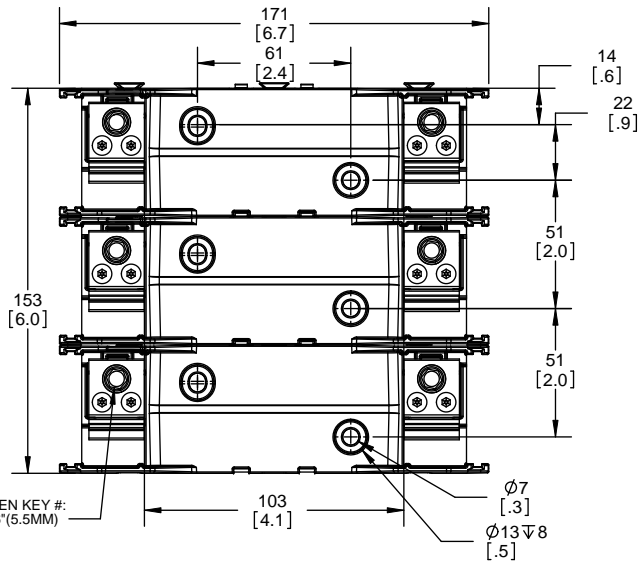

**RM25100-3CR  
WITH CVR-RH-25100 INSTALLED**



**RM25100-3CR  
WITH CVRI-RH-25100 INSTALLED**

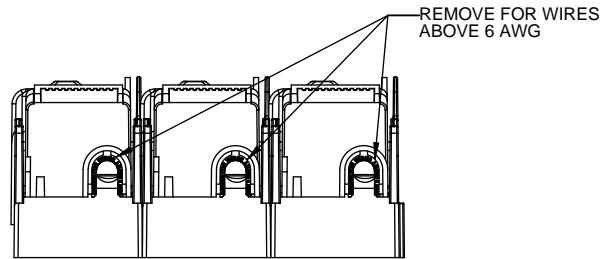
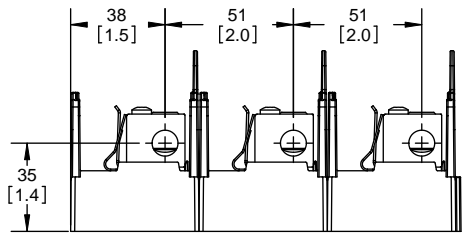
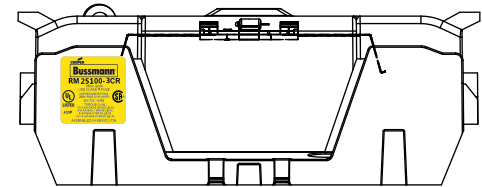
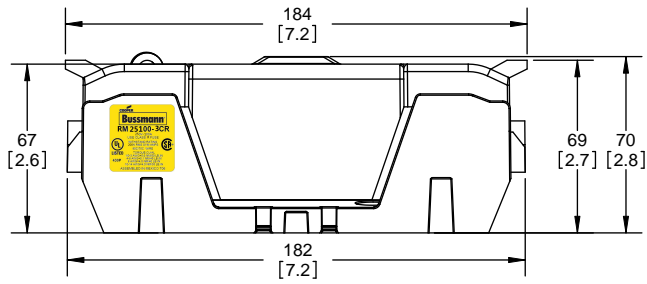
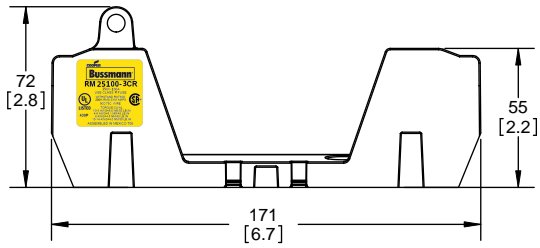
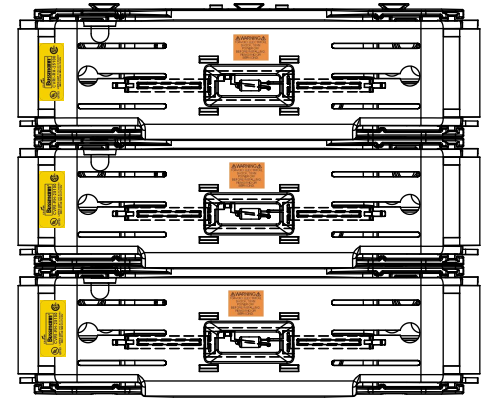

**COOPER Bussmann**  
St. Louis MO 63178

**Class R fuse holder-CUST-250V**

SCALE: 1:1      SIZE: A3      SHEET: 5 OF 14



DESIGN UNITS: METRIC (mm)  
UNLESS OTHERWISE SPECIFIED  
[INCHES]



THIRD ANGLE PROJECTION

**RM25200-2CR**

**RM25200-2CR  
WITH CVR-RH-25200 INSTALLED**

**RM25200-2CR  
WITH CVRI-RH-25200 INSTALLED**



**COOPER Bussmann**  
St. Louis MO 63178

TITLE:  
**Class R fuse holder-CUST-250V**

SCALE: 1:1      SIZE: A3      SHEET: 7 OF 14

DESIGN UNITS: METRIC (mm)  
UNLESS OTHERWISE SPECIFIED [INCHES]



THIRD ANGLE PROJECTION

**RM25200-3CR**

**RM25200-3CR  
WITH CVR-RH-25200 INSTALLED**

**RM25200-3CR  
WITH CVRI-RH-25200 INSTALLED**

ALLEN KEY #:  
3/8" (10.0MM)



**COOPER Bussmann**  
St. Louis MO 63178

TITLE:  
**Class R fuse holder-CUST-250V**

SCALE: 1:1      SIZE: A3      SHEET: 8 OF 14



DESIGN UNITS: METRIC (mm)  
UNLESS OTHERWISE SPECIFIED  
[INCHES]

THIRD ANGLE PROJECTION

**RM25400-1CR**



**RM25400-1CR  
WITH CVR-RH-25400 INSTALLED**

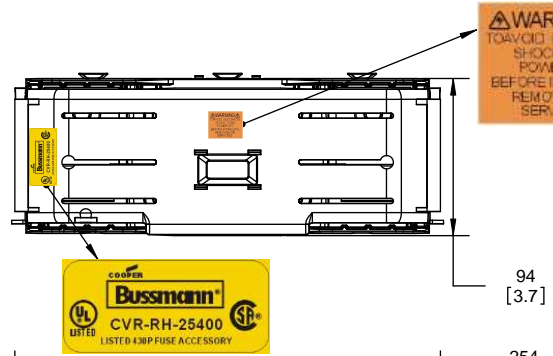

**RM25400-1CR  
WITH CVRI-RH-25400 INSTALLED**

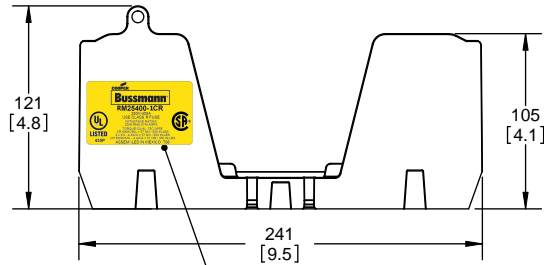
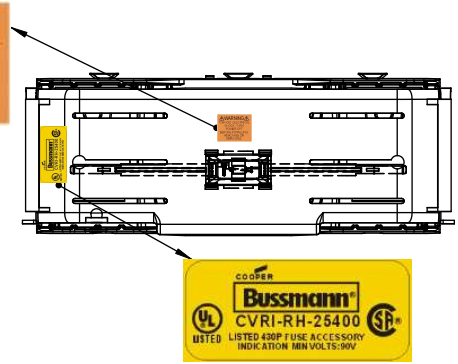

**CVR-RH-25400**



**CVRI-RH-25400**

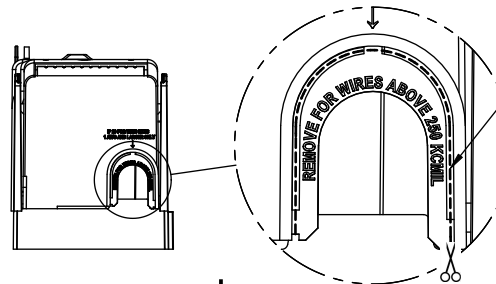
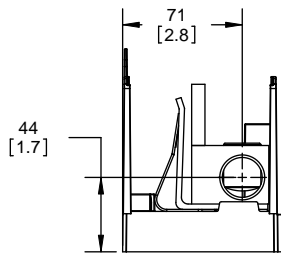

**COOPER Bussmann**  
St. Louis MO 63178

**Class R fuse holder-CUST-250V**

SCALE: 1:1 SIZE: A3 SHEET: 9 OF 14

DESIGN UNITS: METRIC (mm)  
UNLESS OTHERWISE SPECIFIED [INCHES]



THIRD ANGLE PROJECTION

**RM25400-2CR**



**RM25400-2CR  
WITH CVR-RH-25400 INSTALLED**

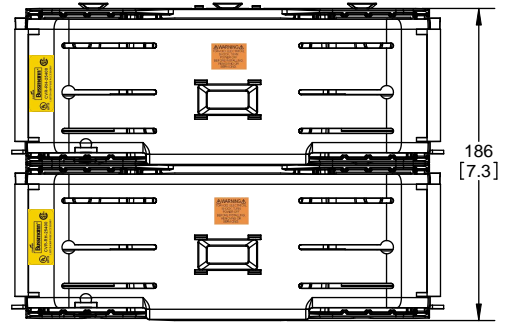

**RM25400-2CR  
WITH CVRI-RH-25400 INSTALLED**

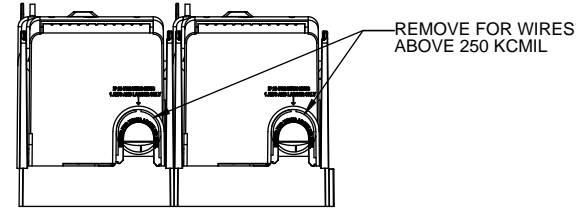
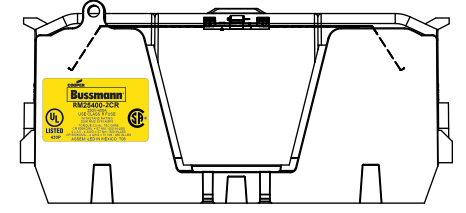
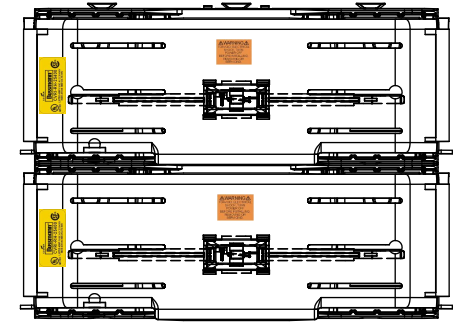

**COOPER Bussmann**  
St. Louis MO 63178

TITLE:  
**Class R fuse holder-CUST-250V**

SCALE: 1:1 SIZE: A3 SHEET: 10 OF 14

DESIGN UNITS: METRIC (mm)  
UNLESS OTHERWISE SPECIFIED [INCHES]

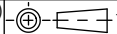

THIRD ANGLE PROJECTION

**RM25400-3CR**

**RM25400-3CR  
WITH CVR-RH-25400 INSTALLED**

**RM25400-3CR  
WITH CVRI-RH-25400 INSTALLED**

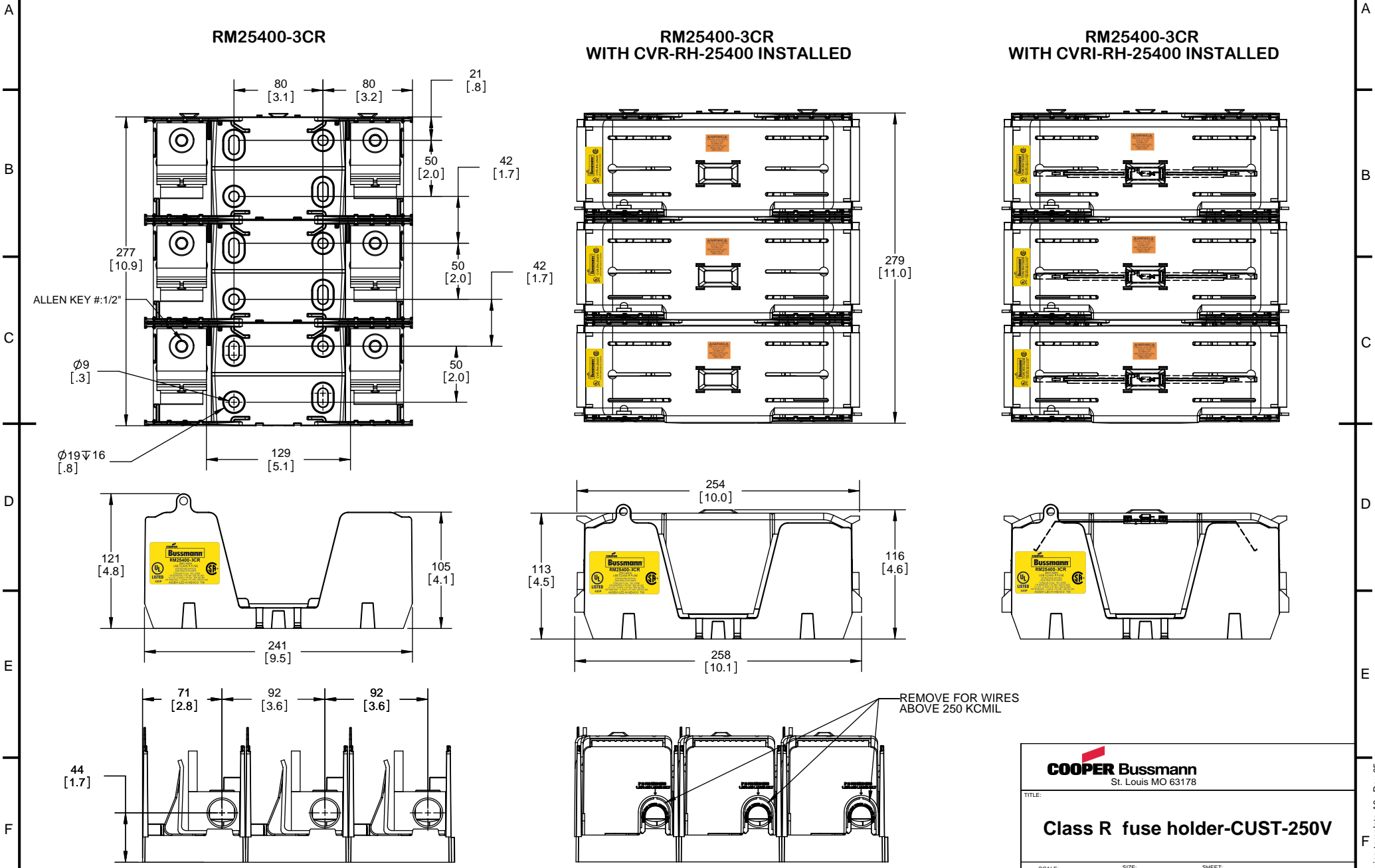

**COOPER Bussmann**  
St. Louis MO 63178

TITLE:  
**Class R fuse holder-CUST-250V**

SCALE: 1:1      SIZE: A3      SHEET: 11 OF 14

DESIGN UNITS: METRIC (mm) UNLESS OTHERWISE SPECIFIED  
 THIRD ANGLE PROJECTION

**RM25600-1CR**



**RM25600-1CR WITH CVR-RH-25600 INSTALLED**

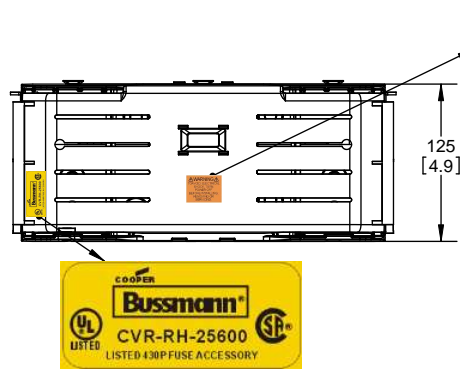

**RM25600-1CR WITH CVRI-RH-25600 INSTALLED**

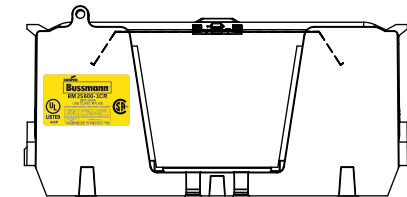
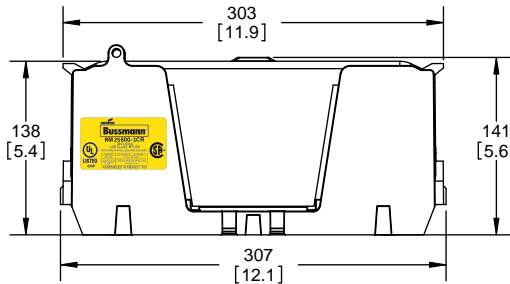
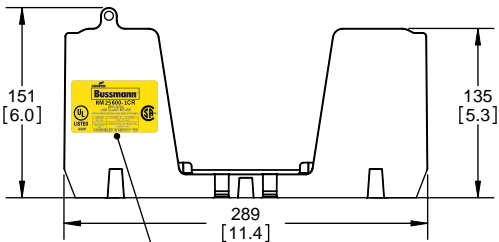
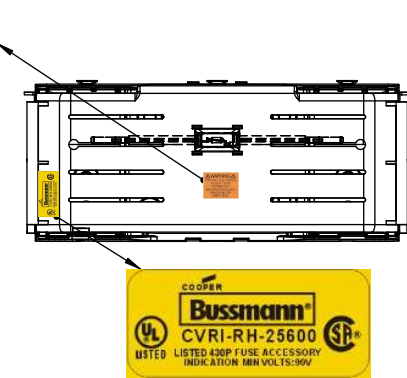

**CVR-RH-25600**

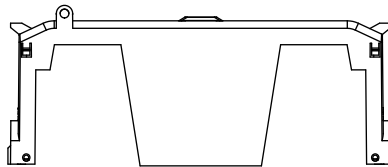

**CVRI-RH-25600**

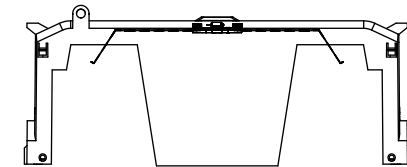

**COOPER Bussmann**  
**RM 25600-1CR**  
 250V-600A  
 USE CLASS R FUSE  
 WITHSTAND RATING 200K RMS SYM AMPS

WIRE SIZE	CUT TORQUE	AL TORQUE
600 KCMIL	87 NM (62 IN-LS)	
DUAL 304 AWG	37 NM (26 IN-LS)	33.9 NM (24 IN-LS)
100 KCMIL	51 NM (36 IN-LS)	51 NM (36 IN-LS)

UL LISTED 430P SA ASSEMBLED IN MEXICO T06

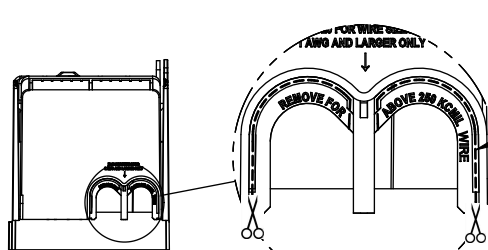

CUT OPEN ALONG THIS DOTTED LINE FOR WIRES ABOVE 250 KCMIL

**COOPER Bussmann**  
 St. Louis MO 63178

**Class R fuse holder-CUST-250V**

SCALE: 1:1 SIZE: A3 SHEET: 12 OF 14

DESIGN UNITS: METRIC (mm)  
UNLESS OTHERWISE SPECIFIED [INCHES]



THIRD ANGLE PROJECTION

**RM25600-2CR**

**RM25600-2CR  
WITH CVR-RH-25600 INSTALLED**

**RM25600-2CR  
WITH CVRI-RH-25600 INSTALLED**



**COOPER Bussmann**  
St. Louis MO 63178

TITLE:  
**Class R fuse holder-CUST-250V**

SCALE: 1:1      SIZE: A3      SHEET: 13 OF 14

DESIGN UNITS: METRIC (mm)  
UNLESS OTHERWISE SPECIFIED  
[INCHES]



THIRD ANGLE PROJECTION

**RM25600-3CR**



**RM25600-3CR  
WITH CVR-RH-25600 INSTALLED**



**RM25600-3CR  
WITH CVRI-RH-25600 INSTALLED**



**COOPER Bussmann**  
St. Louis MO 63178

TITLE: **Class R fuse holder-CUST-250V**

SCALE: 1:1      SIZE: A3      SHEET: 14 OF 14

REVISIONS			DATE	ECN	BY
REV	ZONE	DESCRIPTION			

**RM60100-1CR**

**RM60100-1CR WITH CVR-RH-60100 INSTALLED**

**RM60100-1CR WITH CVRI-RH-60100 INSTALLED**

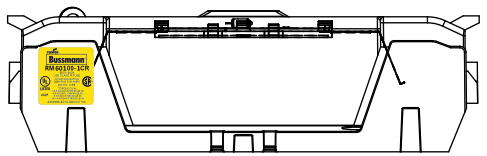
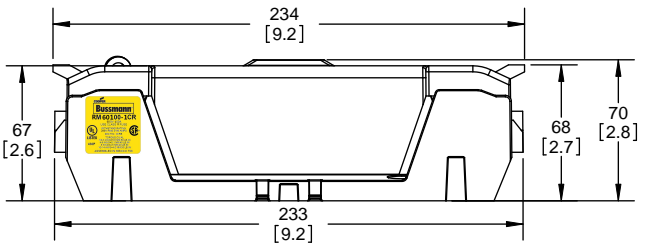
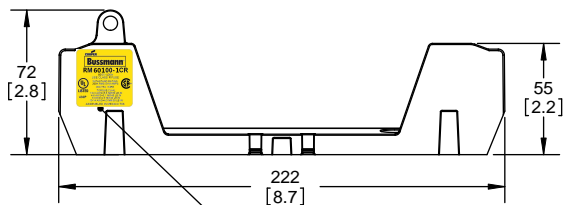

**CVR-RH-60100**

**CVRI-RH-60100**

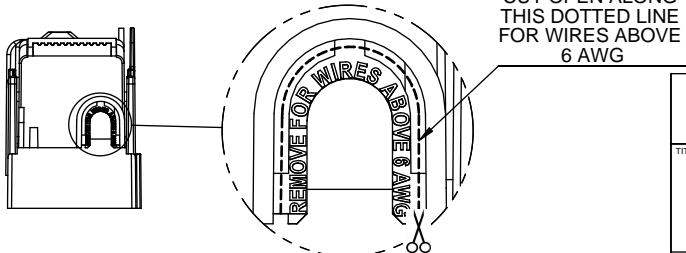
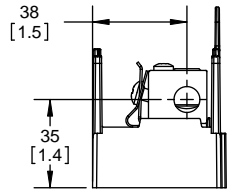
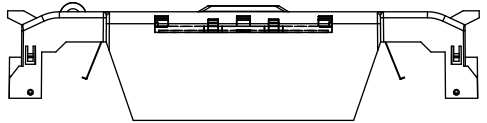
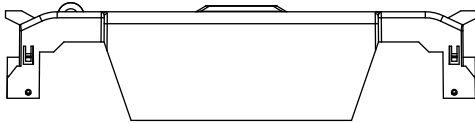

**COOPER Bussmann**  
St. Louis MO 63178

TITLE: **Class R fuse holder-CUST-600V**

SCALE: 1:1 SIZE: A3 SHEET: 1 OF 12

DESIGN UNITS: METRIC (mm)  
UNLESS OTHERWISE SPECIFIED  
[INCHES]



THIRD ANGLE PROJECTION

REVISIONS				DATE	ECN	BY
REV	ZONE	DESCRIPTION				

**RM60100-2CR**

**RM60100-2CR  
WITH CVR-RH-60100 INSTALLED**

**RM60100-2CR  
WITH CVRI-RH-60100 INSTALLED**

ALLEN KEY  
#3/16" (5.5MM)

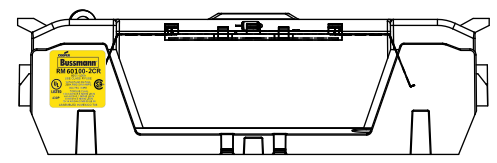

**COOPER Bussmann**  
St. Louis MO 63178

TITLE:  
**Class R fuse holder-CUST-600V**

SCALE: 1:1      SIZE: A3      SHEET: 2 OF 12



**RM60100-3CR**

**RM60100-3CR WITH CVR-RH-60100 INSTALLED**

**RM60100-3CR WITH CVRI-RH-60100 INSTALLED**



**COOPER Bussmann**  
St. Louis MO 63178

TITLE:  
**Class R fuse holder-CUST-600V**

SCALE: 1:1      SIZE: A3      SHEET: 3 OF 12

REVISIONS			DATE	ECN	BY
REV	ZONE	DESCRIPTION			

**RM60200-1CR**

**RM60200-1CR WITH CVR-RH-60200 INSTALLED**

**RM60200-1CR WITH CVRI-RH-60200 INSTALLED**



**CVR-RH-60200**

**CVRI-RH-60200**



**COOPER Bussmann**  
St. Louis MO 63178

TITLE: **Class R fuse holder-CUST-600V**

SCALE: 1:1 SIZE: A3 SHEET: 4 OF 12

**RM60200-2CR**

**RM60200-2CR  
WITH CVR-RH-60200 INSTALLED**

**RM60200-2CR  
WITH CVRI-RH-60200 INSTALLED**

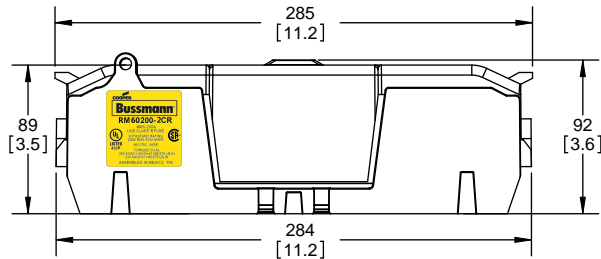
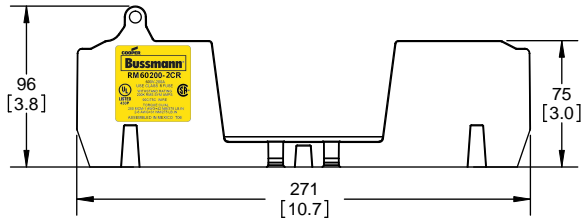
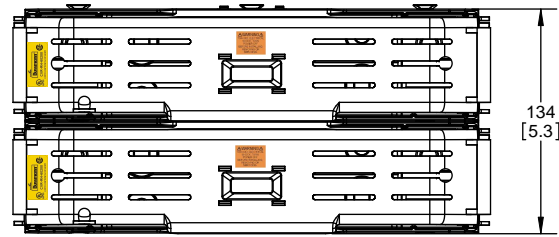

**COOPER Bussmann**  
St. Louis MO 63178

TITLE: **Class R fuse holder-CUST-600V**

SCALE: 1:1      SIZE: A3      SHEET: 5 OF 12

**RM60200-3CR**

**RM60200-3CR  
WITH CVR-RH-60200 INSTALLED**

**RM60200-3CR  
WITH CVRI-RH-60200 INSTALLED**

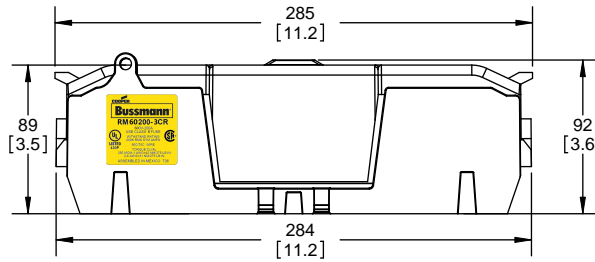
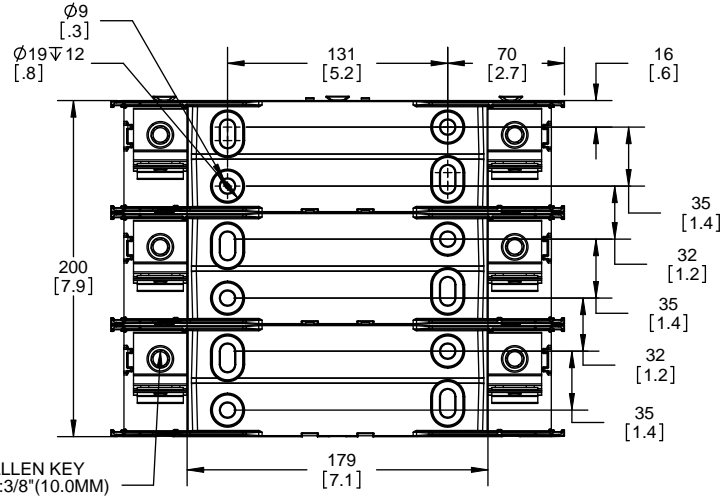

**COOPER Bussmann**  
St. Louis MO 63178

TITLE: **Class R fuse holder-CUST-600V**

SCALE: 1:1      SIZE: A3      SHEET: 6 OF 12

**RM60400-1CR**



**RM60400-1CR WITH CVR-RH-60400 INSTALLED**



**RM60400-1CR WITH CVRI-RH-60400 INSTALLED**

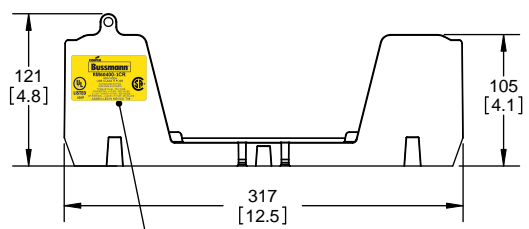

**COOPER Bussmann RM60400-1CR**  
600V-400A  
USE CLASS R FUSE  
WITHSTAND RATING  
200K RMS SYM AMPS  
TORQUE CU/AL 75C WIRE  
CR 600KCMIL = 57 NM / 500 IN-LBS  
2 x 3/0 - 4 AWG = 57 NM / 500 IN-LBS  
CR 500KCMIL - 4 AWG = 51 NM / 450 IN-LBS  
ASSEMBLED IN MEXICO T06

UL LISTED 430P

**CVR-RH-60400**

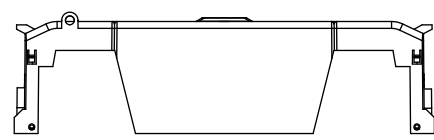

**CVRI-RH-60400**

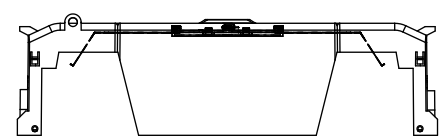

CUT OPEN ALONG THIS DOTTED LINE FOR WIRES ABOVE 250 KCMIL

**COOPER Bussmann**  
St. Louis MO 63178

TITLE: **Class R fuse holder-CUST-600V**

SCALE: 1:1 SIZE: A3 SHEET: 7 OF 12

REVISIONS			DATE	ECN	BY
REV	ZONE	DESCRIPTION			

**RM60400-2CR**



**RM60400-2CR  
WITH CVR-RH-60400 INSTALLED**



**RM60400-2CR  
WITH CVRI-RH-60400 INSTALLED**



**COOPER Bussmann**  
St. Louis MO 63178

TITLE:  
**Class R fuse holder-CUST-600V**

SCALE: 1:1    SIZE: A3    SHEET: 8 OF 12

REVISIONS			DATE	ECN	BY
REV	ZONE	DESCRIPTION			

**RM60400-3CR**

**RM60400-3CR  
WITH CVR-RH-60400 INSTALLED**

**RM60400-3CR  
WITH CVRI-RH-60400 INSTALLED**



**COOPER Bussmann**  
St. Louis MO 63178

TITLE:  
**Class R fuse holder-CUST-600V**

SCALE: 1:1      SIZE: A3      SHEET: 9 OF 12





REVISIONS				DATE	ECN	BY
REV	ZONE	DESCRIPTION				

**RM60600-2CR**



**RM60600-2CR  
WITH CVR-RH-60600 INSTALLED**



**RM60600-2CR  
WITH CVRI-RH-60600 INSTALLED**



**COOPER Bussmann**  
St. Louis MO 63178

TITLE:  
**Class R fuse holder-CUST-600V**

SCALE: 1:5      SIZE: A3      SHEET: 11 OF 12

REVISIONS				DATE	ECN	BY
REV	ZONE	DESCRIPTION				

**RM60600-3CR**



**RM60600-3CR  
WITH CVR-RH-60600 INSTALLED**



**RM60600-3CR  
WITH CVRI-RH-60600 INSTALLED**



**COOPER Bussmann**  
St. Louis MO 63178

TITLE:  
**Class R fuse holder-CUST-600V**

SCALE: 1:5      SIZE: A3      SHEET: 12 OF 12

## Данный компонент на территории Российской Федерации

### Вы можете приобрести в компании MosChip.

Для оперативного оформления запроса Вам необходимо перейти по данной ссылке:

<http://moschip.ru/get-element>

Вы можете разместить у нас заказ для любого Вашего проекта, будь то серийное производство или разработка единичного прибора.

В нашем ассортименте представлены ведущие мировые производители активных и пассивных электронных компонентов.

Нашей специализацией является поставка электронной компонентной базы двойного назначения, продукции таких производителей как XILINX, Intel (ex.ALTERA), Vicor, Microchip, Texas Instruments, Analog Devices, Mini-Circuits, Amphenol, Glenair.

Сотрудничество с глобальными дистрибьюторами электронных компонентов, предоставляет возможность заказывать и получать с международных складов практически любой перечень компонентов в оптимальные для Вас сроки.

На всех этапах разработки и производства наши партнеры могут получить квалифицированную поддержку опытных инженеров.

Система менеджмента качества компании отвечает требованиям в соответствии с ГОСТ Р ИСО 9001, ГОСТ РВ 0015-002 и ЭС РД 009

### Офис по работе с юридическими лицами:

105318, г.Москва, ул.Щербаковская д.3, офис 1107, 1118, ДЦ «Щербаковский»

Телефон: +7 495 668-12-70 (многоканальный)

Факс: +7 495 668-12-70 (доб.304)

E-mail: [info@moschip.ru](mailto:info@moschip.ru)

Skype отдела продаж:

moschip.ru

moschip.ru\_4

moschip.ru\_6

moschip.ru\_9