

Class R Fuseblocks Catalog Data

Catalog Number	Covers		Voltage	Current	Number of Poles	Label
	Class R	w/o Indication				
RM25100-1CR	CVR-RH-25100	CVRI-RH-25100	250	100	1	RM25100-1CR
RM25100-2CR					2	RM25100-2CR
RM25100-3CR					3	RM25100-3CR
RM25200-1CR	CVR-RH-25200	CVRI-RH-25200		200	1	RM25200-1CR
RM25200-2CR					2	RM25200-2CR
RM25200-3CR					3	RM25200-3CR
RM25400-1CR	CVR-RH-25400	CVRI-RH-25400		400	1	RM25400-1CR
RM25400-2CR					2	RM25400-2CR
RM25400-3CR					3	RM25400-3CR
RM25600-1CR	CVR-RH-25600	CVRI-RH-25600		600	1	RM25600-1CR
RM25600-2CR					2	RM25600-2CR
RM25600-3CR					3	RM25600-3CR

Catalog Number	Covers		Voltage	Current	Number of Poles	Label
	Class R	w/o Indication				
RM60100-1CR	CVR-RH-60100	CVRI-RH-60100	600	100	1	RM60100-1CR
RM60100-2CR					2	RM60100-2CR
RM60100-3CR					3	RM60100-3CR
RM60200-1CR	CVR-RH-60200	CVRI-RH-60200		200	1	RM60200-1CR
RM60200-2CR					2	RM60200-2CR
RM60200-3CR					3	RM60200-3CR
RM60400-1CR	CVR-RH-60400	CVRI-RH-60400		400	1	RM60400-1CR
RM60400-2CR					2	RM60400-2CR
RM60400-3CR					3	RM60400-3CR
RM60600-1CR	CVR-RH-60600	CVRI-RH-60600		600	1	RM60600-1CR
RM60600-2CR					2	RM60600-2CR
RM60600-3CR					3	RM60600-3CR

COOPER Bussmann
St. Louis MO 63178

TITLE:
Class R fuse holder-CUST

SCALE: 1:1 SIZE: A3 SHEET: 1 OF 14



PUSH DOWN

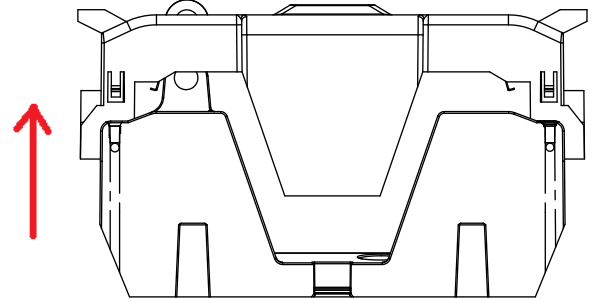

LIFT UP

LIFT UP, THEN
ROTATE OVER



 St. Louis MO 63178		
TITLE:		
Class R fuse holder-CUST		
SCALE: 1:2	SIZE: A3	SHEET: 2 OF 14
www.Bussmann.com		

RM25100-1CR

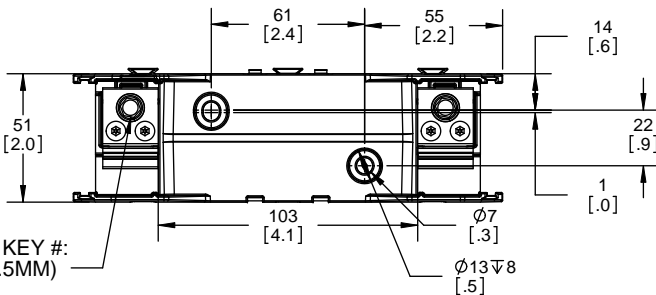

ALLEN KEY #: 3/16" (5.5MM)

Ø7 [.3]
Ø13▽8 [.5]

RM25100-1CR WITH CVR-RH-25100 INSTALLED

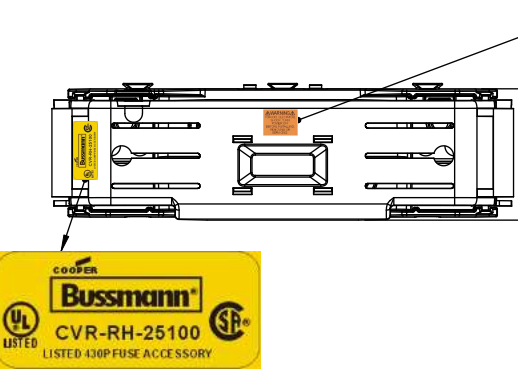

RM25100-1CR WITH CVRI-RH-25100 INSTALLED

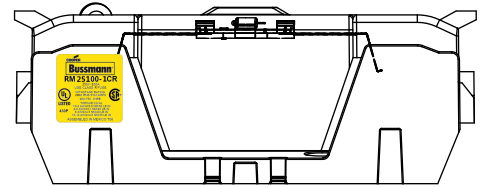
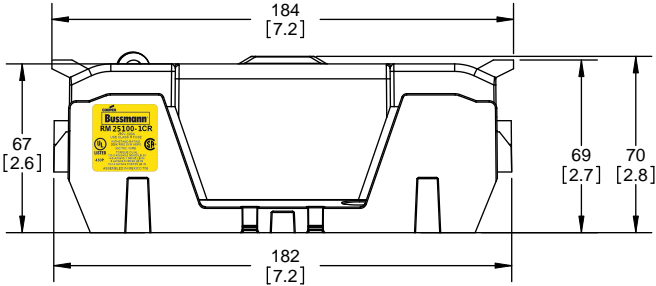
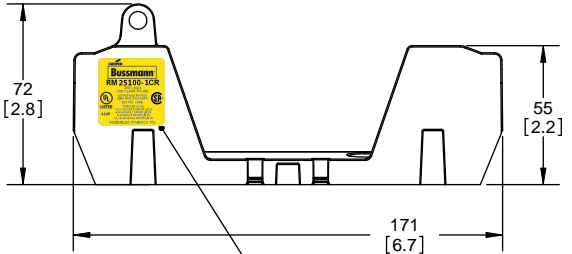
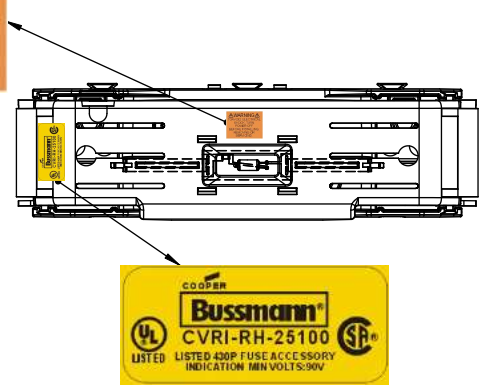

CVR-RH-25100

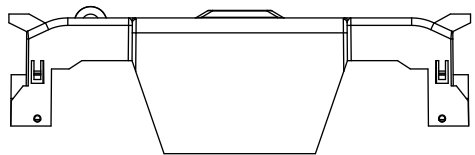

CVRI-RH-25100

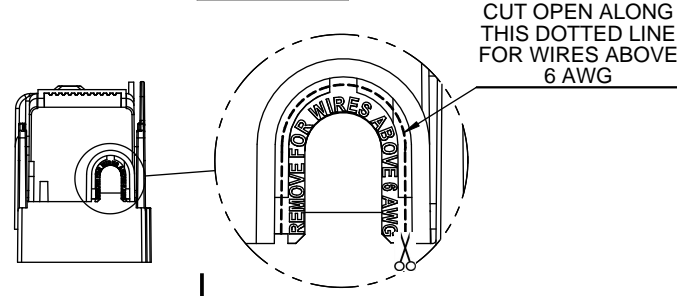
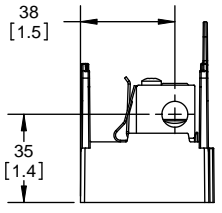
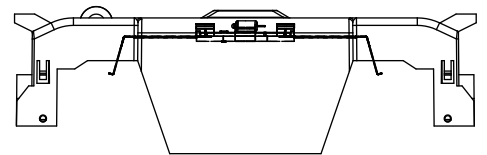

COOPER Bussmann
St. Louis MO 63178

TITLE: **Class R fuse holder-CUST-250V**

SCALE: 1:1 SIZE: A3 SHEET: 3 OF 14

DESIGN UNITS: METRIC (mm)
UNLESS OTHERWISE SPECIFIED
[INCHES]



THIRD ANGLE PROJECTION

RM25100-2CR

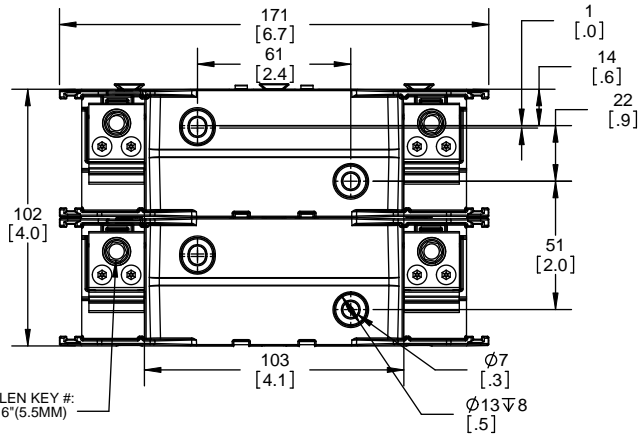

**RM25100-2CR
WITH CVR-RH-25100 INSTALLED**

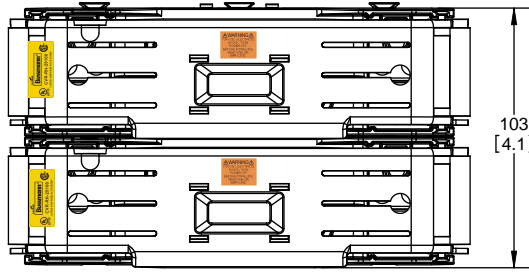

**RM25100-2CR
WITH CVRI-RH-25100 INSTALLED**

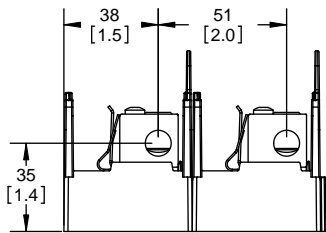
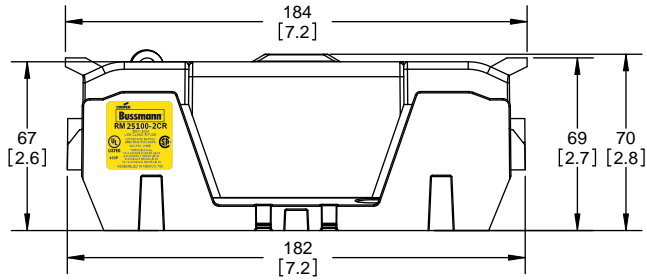
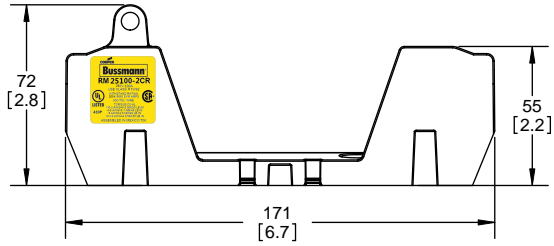
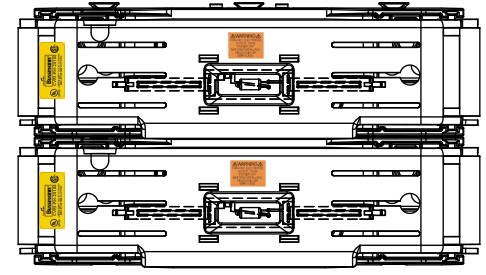

COOPER Bussmann
St. Louis MO 63178

Class R fuse holder-CUST-250V

SCALE: 1:1 SIZE: A3 SHEET: 4 OF 14

DESIGN UNITS: METRIC (mm)
UNLESS OTHERWISE SPECIFIED [INCHES]



THIRD ANGLE PROJECTION

RM25100-3CR



**RM25100-3CR
WITH CVR-RH-25100 INSTALLED**

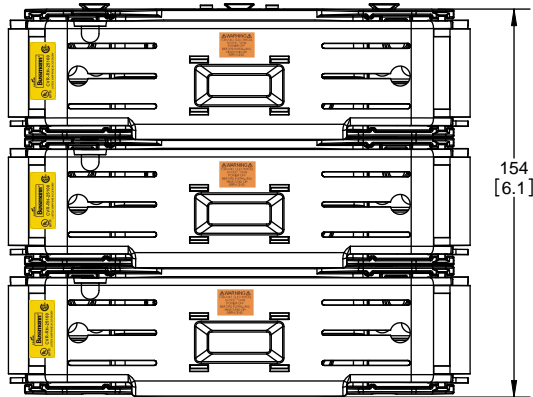

**RM25100-3CR
WITH CVRI-RH-25100 INSTALLED**

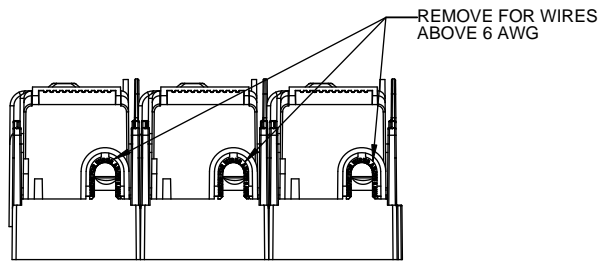
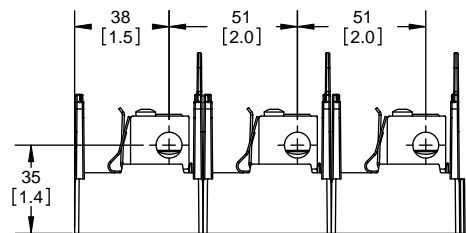
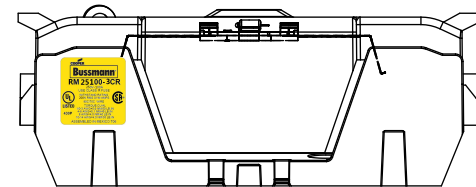
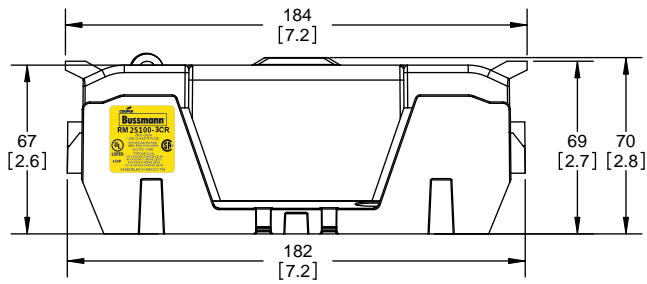
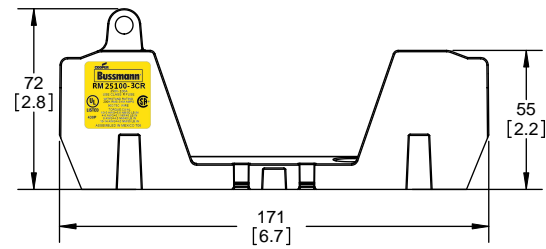
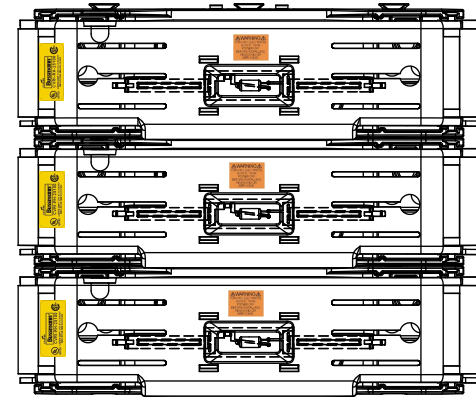

COOPER Bussmann
St. Louis MO 63178

TITLE:
Class R fuse holder-CUST-250V

SCALE: 1:1 SIZE: A3 SHEET: 5 OF 14

DESIGN UNITS: METRIC (mm)
UNLESS OTHERWISE SPECIFIED [INCHES]



THIRD ANGLE PROJECTION

RM25200-1CR

ALLEN KEY #:
3/8"(10.0MM)

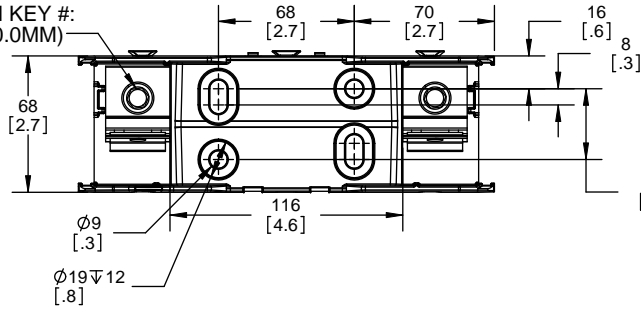

**RM25200-1CR
WITH CVR-RH-25200 INSTALLED**

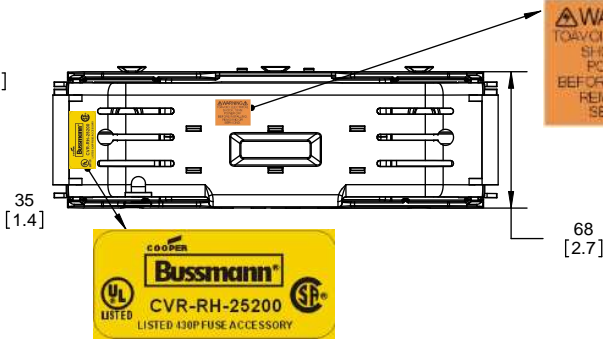

**RM25200-1CR
WITH CVRI-RH-25200 INSTALLED**

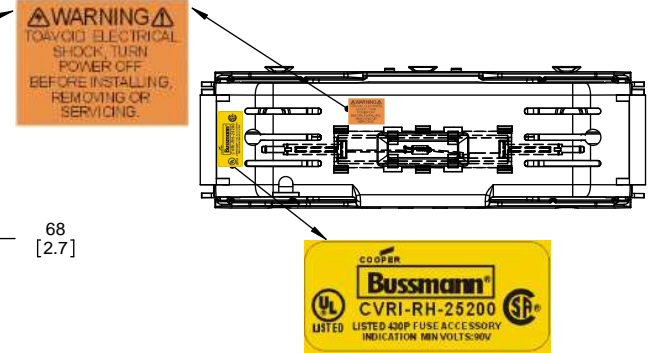

WARNING
⚠️ TO AVOID ELECTRICAL SHOCK, TURN POWER OFF BEFORE INSTALLING, REMOVING OR SERVICING.

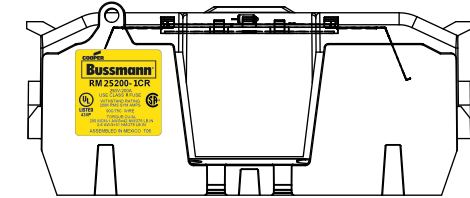
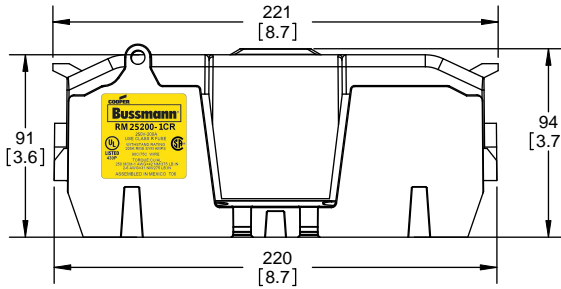
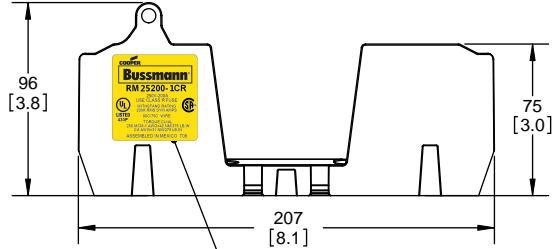

COOPER Bussmann
RM 25200-1CR

250V-200A
USE CLASS R FUSE
WITHSTAND RATING
200K RMS SYM AMPS
90C/75C WIRE
TORQUE: CU/AL
250 MCM-1 AWG=42 NM/375 LB.IN
2-6 AWG=31 NM/275 LB.IN
ASSEMBLED IN MEXICO T06

UL LISTED 430P SF

CVR-RH-25200

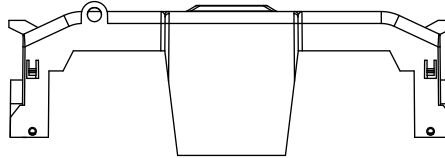

CVRI-RH-25200

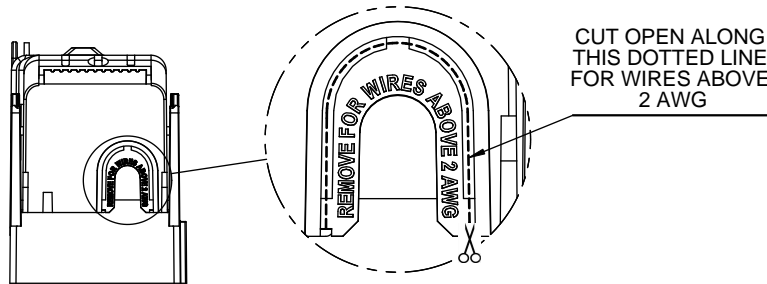
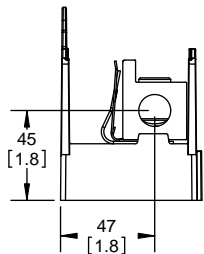
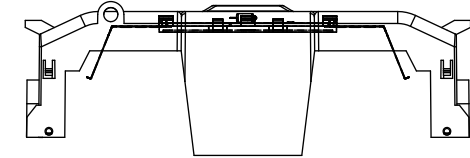

COOPER Bussmann
St. Louis MO 63178

TITLE:
Class R fuse holder-CUST-250V

SCALE: 1:1 SIZE: A3 SHEET: 6 OF 14

DESIGN UNITS: METRIC (mm)
UNLESS OTHERWISE SPECIFIED
[INCHES]



THIRD ANGLE PROJECTION

RM25200-2CR

**RM25200-2CR
WITH CVR-RH-25200 INSTALLED**

**RM25200-2CR
WITH CVRI-RH-25200 INSTALLED**



COOPER Bussmann
St. Louis MO 63178

TITLE:
Class R fuse holder-CUST-250V

SCALE: 1:1 SIZE: A3 SHEET: 7 OF 14

DESIGN UNITS: METRIC (mm)
UNLESS OTHERWISE SPECIFIED [INCHES]



THIRD ANGLE PROJECTION

RM25200-3CR

**RM25200-3CR
WITH CVR-RH-25200 INSTALLED**

**RM25200-3CR
WITH CVRI-RH-25200 INSTALLED**

ALLEN KEY #:
3/8" (10.0MM)

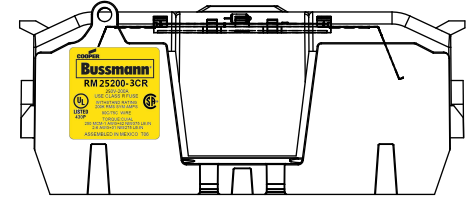

COOPER Bussmann
St. Louis MO 63178

TITLE:
Class R fuse holder-CUST-250V

SCALE: 1:1 SIZE: A3 SHEET: 8 OF 14

DESIGN UNITS: METRIC (mm) UNLESS OTHERWISE SPECIFIED
 THIRD ANGLE PROJECTION

RM25400-1CR



RM25400-1CR WITH CVR-RH-25400 INSTALLED

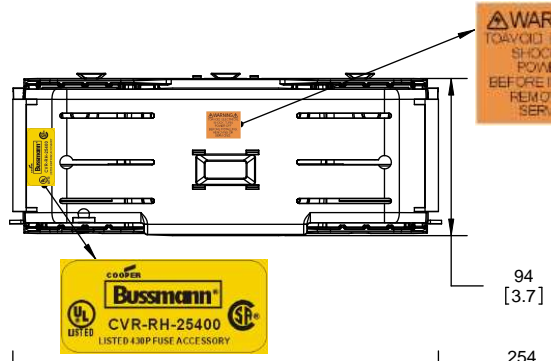

RM25400-1CR WITH CVRI-RH-25400 INSTALLED

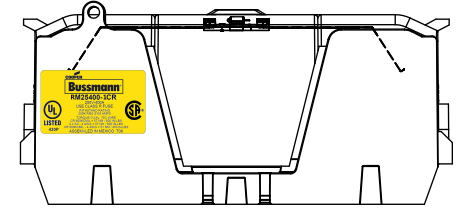
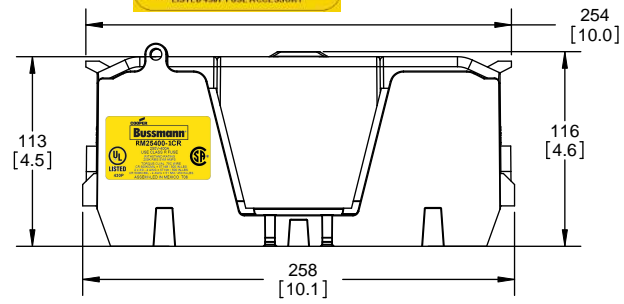
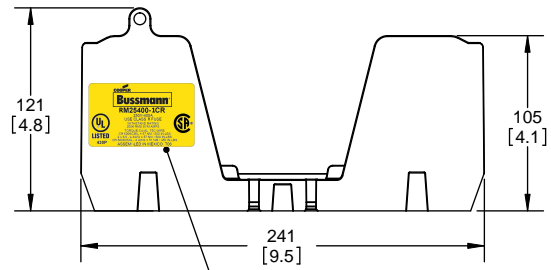
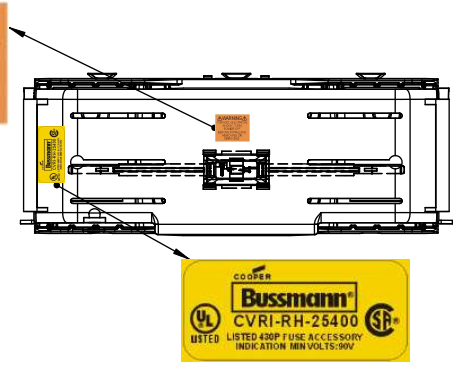

CVR-RH-25400

CVRI-RH-25400

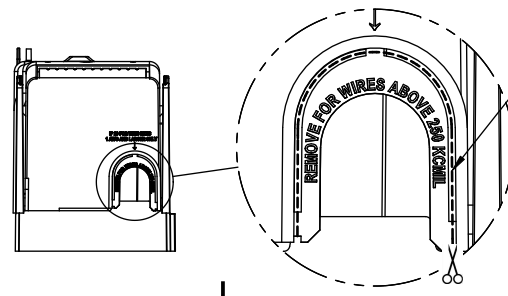
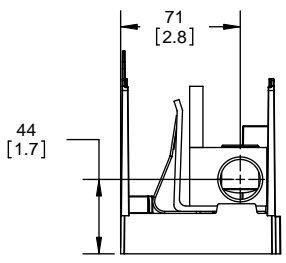
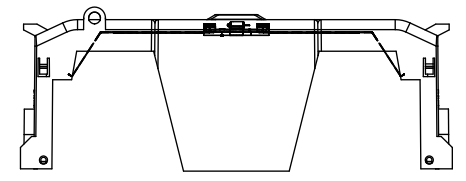
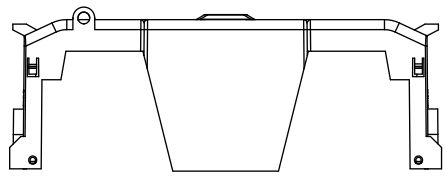

COOPER Bussmann
 St. Louis MO 63178

TITLE:
Class R fuse holder-CUST-250V

SCALE: 1:1 SIZE: A3 SHEET: 9 OF 14

DESIGN UNITS: METRIC (mm)
UNLESS OTHERWISE SPECIFIED [INCHES]

THIRD ANGLE PROJECTION

RM25400-2CR



**RM25400-2CR
WITH CVR-RH-25400 INSTALLED**



**RM25400-2CR
WITH CVRI-RH-25400 INSTALLED**



COOPER Bussmann
St. Louis MO 63178

TITLE:
Class R fuse holder-CUST-250V

SCALE: 1:1 SIZE: A3 SHEET: 10 OF 14

DESIGN UNITS: METRIC (mm)
UNLESS OTHERWISE SPECIFIED
[INCHES]



THIRD ANGLE PROJECTION

RM25400-3CR



RM25400-3CR
WITH CVR-RH-25400 INSTALLED



RM25400-3CR
WITH CVRI-RH-25400 INSTALLED



COOPER Bussmann
St. Louis MO 63178

TITLE:
Class R fuse holder-CUST-250V

SCALE: 1:1 SIZE: A3 SHEET: 11 OF 14

DESIGN UNITS: METRIC (mm) UNLESS OTHERWISE SPECIFIED
 THIRD ANGLE PROJECTION

RM25600-1CR



RM25600-1CR WITH CVR-RH-25600 INSTALLED



RM25600-1CR WITH CVRI-RH-25600 INSTALLED

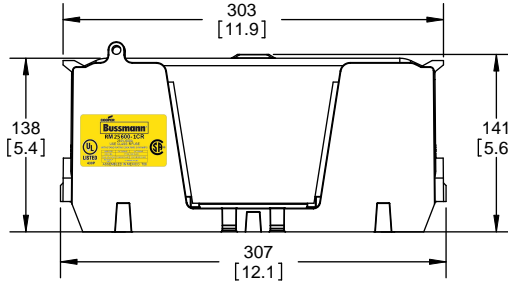
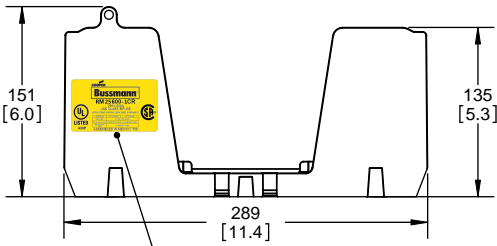
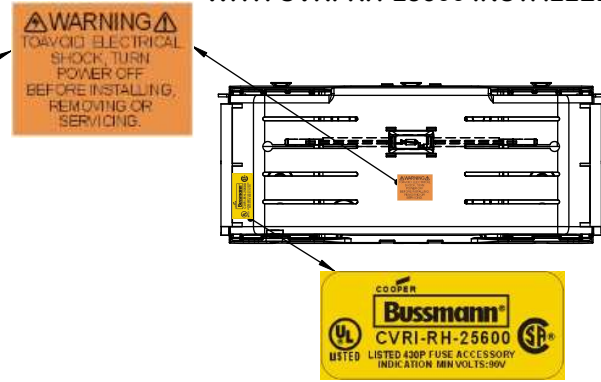

CVR-RH-25600

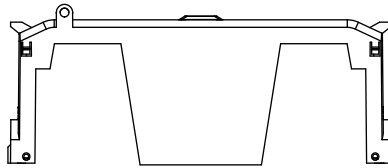

CVRI-RH-25600

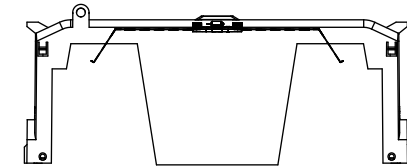

Bussmann
 RM 25600-1CR
 250V-600A
 USE CLASS R FUSE
 WITHSTAND RATING 200K RMS SYM AMPS

WIRE SIZE	CUT TORQUE	AL TORQUE
600 KCMIL	87 NM / 620 IN-LBS	
DUAL 304 AWG	37 NM/300 IN-LBS	33.9 NM/300 IN-LBS
100 KCMIL	51 NM/450 IN-LBS	

UL LISTED 430P SA ASSEMBLED IN MEXICO T06

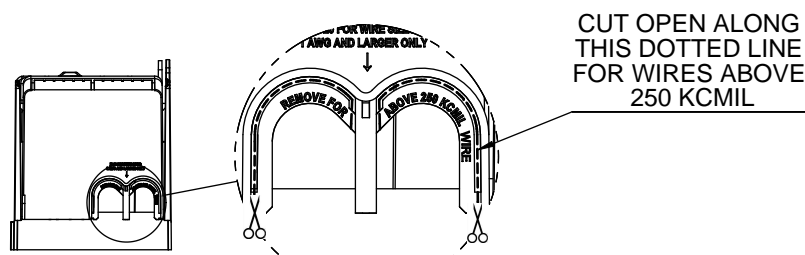

COOPER Bussmann
 St. Louis MO 63178

TITLE: **Class R fuse holder-CUST-250V**

SCALE: 1:1 SIZE: A3 SHEET: 12 OF 14

DESIGN UNITS: METRIC (mm)
UNLESS OTHERWISE SPECIFIED [INCHES]



THIRD ANGLE PROJECTION

RM25600-2CR

**RM25600-2CR
WITH CVR-RH-25600 INSTALLED**

**RM25600-2CR
WITH CVRI-RH-25600 INSTALLED**



COOPER Bussmann
St. Louis MO 63178

TITLE:
Class R fuse holder-CUST-250V

SCALE: 1:1 SIZE: A3 SHEET: 13 OF 14

DESIGN UNITS: METRIC (mm)
UNLESS OTHERWISE SPECIFIED
[INCHES]



THIRD ANGLE PROJECTION

RM25600-3CR



**RM25600-3CR
WITH CVR-RH-25600 INSTALLED**



**RM25600-3CR
WITH CVRI-RH-25600 INSTALLED**



COOPER Bussmann
St. Louis MO 63178

TITLE:
Class R fuse holder-CUST-250V

SCALE: 1:1 SIZE: A3 SHEET: 14 OF 14

REVISIONS			DATE	ECN	BY
REV	ZONE	DESCRIPTION			

RM60100-1CR

RM60100-1CR WITH CVR-RH-60100 INSTALLED

RM60100-1CR WITH CVRI-RH-60100 INSTALLED

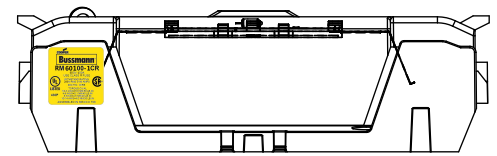
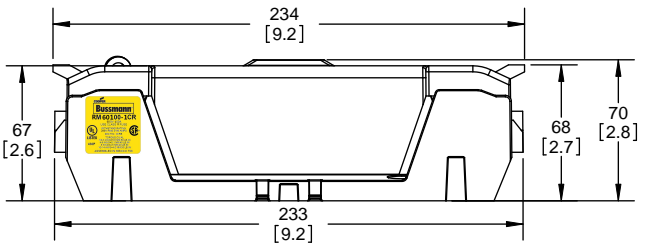
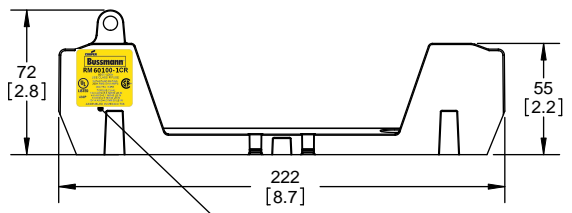

CVR-RH-60100

CVRI-RH-60100

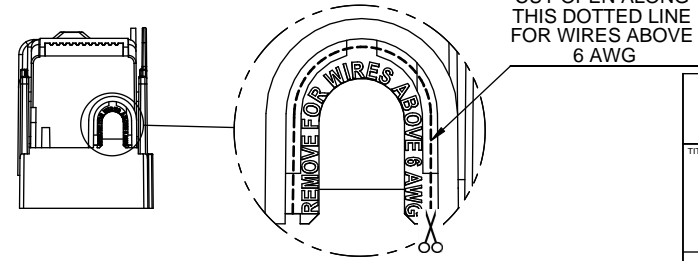
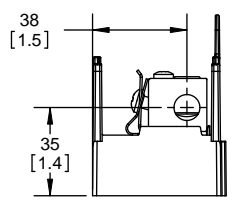
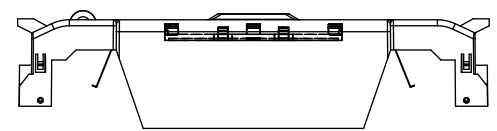
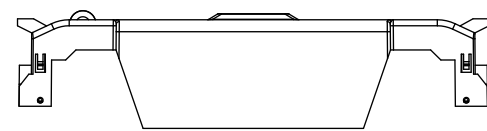

COOPER Bussmann
St. Louis MO 63178

TITLE: **Class R fuse holder-CUST-600V**

SCALE: 1:1 SIZE: A3 SHEET: 1 OF 12

REVISIONS					
REV	ZONE	DESCRIPTION	DATE	ECN	BY

RM60100-2CR

**RM60100-2CR
WITH CVR-RH-60100 INSTALLED**

**RM60100-2CR
WITH CVRI-RH-60100 INSTALLED**

ALLEN KEY
#3/16" (5.5MM)



COOPER Bussmann
St. Louis MO 63178

TITLE:
Class R fuse holder-CUST-600V

SCALE: 1:1 SIZE: A3 SHEET: 2 OF 12

RM60100-3CR

RM60100-3CR WITH CVR-RH-60100 INSTALLED

RM60100-3CR WITH CVRI-RH-60100 INSTALLED



COOPER Bussmann
St. Louis MO 63178

TITLE:
Class R fuse holder-CUST-600V

SCALE: 1:1 SIZE: A3 SHEET: 3 OF 12

REVISIONS			DATE	ECN	BY
REV	ZONE	DESCRIPTION			

RM60200-1CR

RM60200-1CR WITH CVR-RH-60200 INSTALLED

RM60200-1CR WITH CVRI-RH-60200 INSTALLED

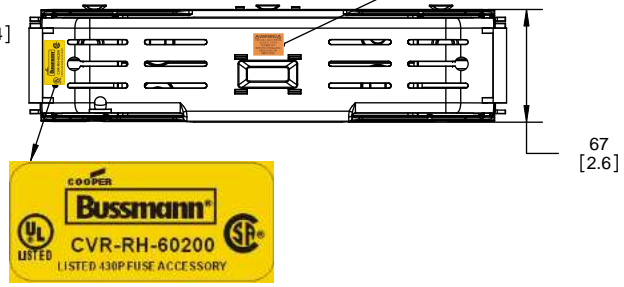

WARNING
TO AVOID ELECTRICAL SHOCK, TURN POWER OFF BEFORE INSTALLING, REMOVING OR SERVICING.

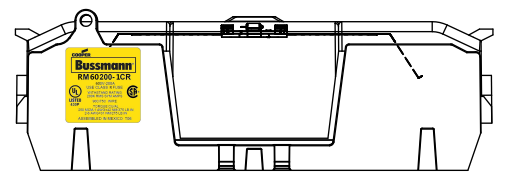
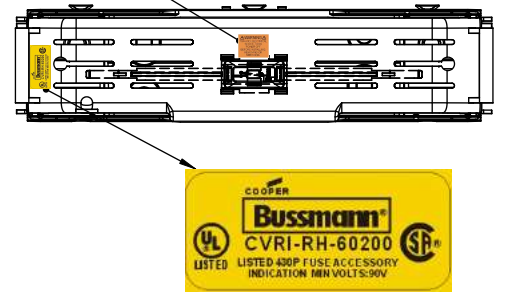

CVR-RH-60200

CVRI-RH-60200

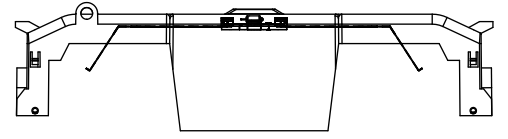
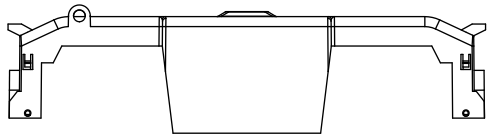

COOPER Bussmann
St. Louis MO 63178

TITLE: **Class R fuse holder-CUST-600V**

SCALE: 1:1 SIZE: A3 SHEET: 4 OF 12

RM60200-2CR

**RM60200-2CR
WITH CVR-RH-60200 INSTALLED**

**RM60200-2CR
WITH CVRI-RH-60200 INSTALLED**

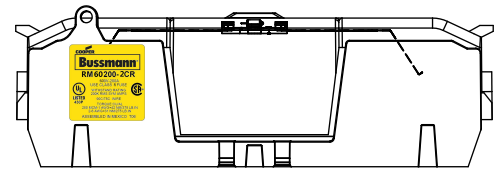
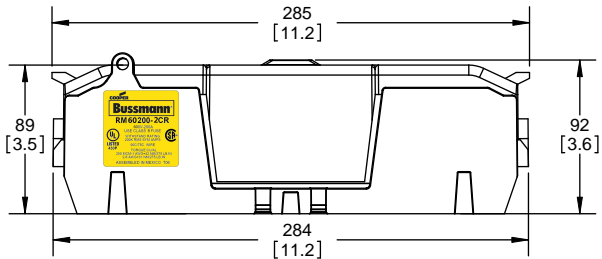
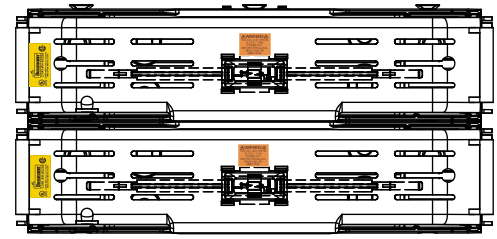
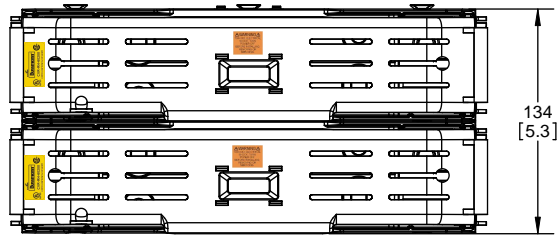

COOPER Bussmann
St. Louis MO 63178

TITLE:
Class R fuse holder-CUST-600V

SCALE: 1:1 SIZE: A3 SHEET: 5 OF 12

RM60200-3CR

**RM60200-3CR
WITH CVR-RH-60200 INSTALLED**

**RM60200-3CR
WITH CVRI-RH-60200 INSTALLED**

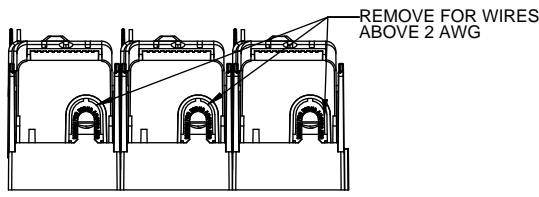
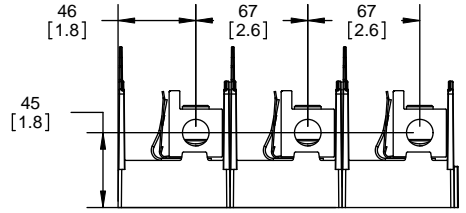
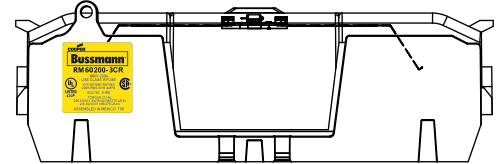
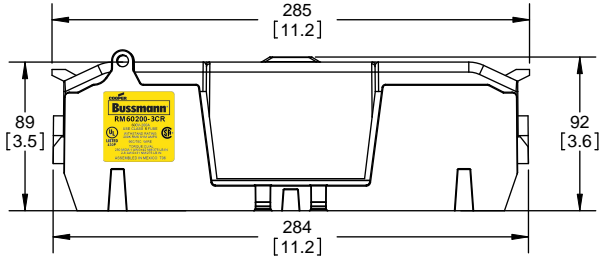
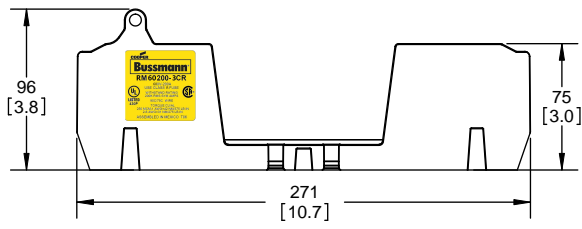
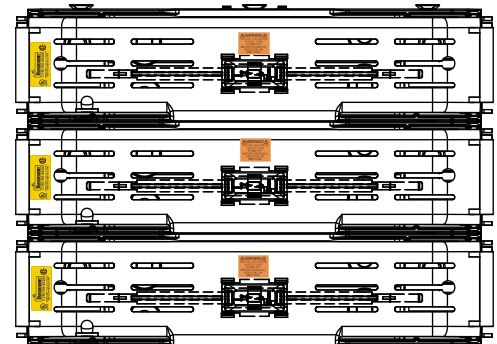
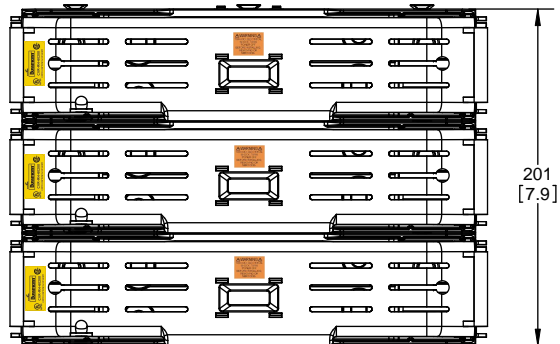
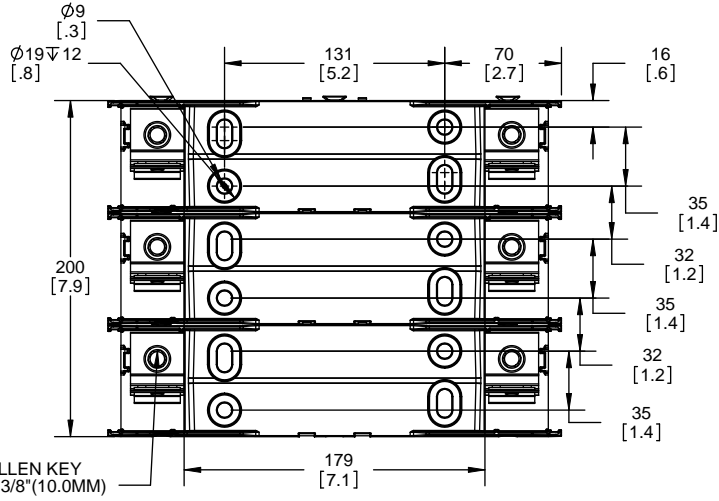

COOPER Bussmann
St. Louis MO 63178

TITLE: **Class R fuse holder-CUST-600V**

SCALE: 1:1 SIZE: A3 SHEET: 6 OF 12

RM60400-1CR



RM60400-1CR WITH CVR-RH-60400 INSTALLED



RM60400-1CR WITH CVRI-RH-60400 INSTALLED



COOPER Bussmann RM60400-1CR
600V-400A
USE CLASS R FUSE
WITHSTAND RATING
200K RMS SYM AMPS
TORQUE: CU/AL 75C WIRE
CR 600KCMIL = 57 NM / 500 IN-LBS
2 x 3/0 - 4 AWG = 57 NM / 500 IN-LBS
CR 500KCMIL - 4 AWG = 51 NM / 450 IN-LBS
ASSEMBLED IN MEXICO T06

UL LISTED 430P

CVR-RH-60400



CVRI-RH-60400



CUT OPEN ALONG THIS DOTTED LINE FOR WIRES ABOVE 250 KCMIL

COOPER Bussmann
St. Louis MO 63178

TITLE:
Class R fuse holder-CUST-600V

SCALE: 1:1 SIZE: A3 SHEET: 7 OF 12

REVISIONS				DATE	ECN	BY
REV	ZONE	DESCRIPTION				

RM60400-2CR



**RM60400-2CR
WITH CVR-RH-60400 INSTALLED**



**RM60400-2CR
WITH CVRI-RH-60400 INSTALLED**



COOPER Bussmann
St. Louis MO 63178

TITLE:
Class R fuse holder-CUST-600V

SCALE: 1:1 SIZE: A3 SHEET: 8 OF 12

REVISIONS			DATE	ECN	BY
REV	ZONE	DESCRIPTION			

RM60400-3CR

**RM60400-3CR
WITH CVR-RH-60400 INSTALLED**

**RM60400-3CR
WITH CVRI-RH-60400 INSTALLED**



COOPER Bussmann
St. Louis MO 63178

TITLE:
Class R fuse holder-CUST-600V

SCALE: 1:1 SIZE: A3 SHEET: 9 OF 12

RM60600-1CR

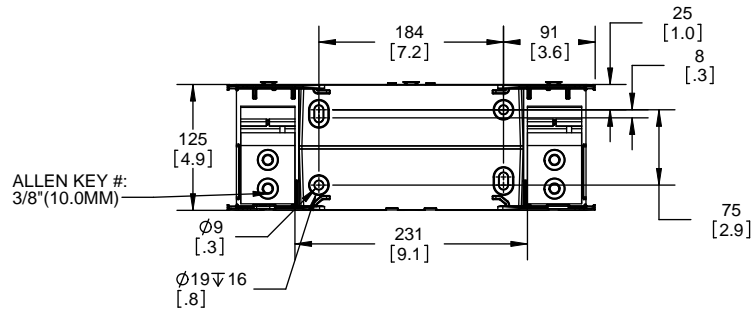

RM60600-1CR WITH CVR-RH-60600 INSTALLED

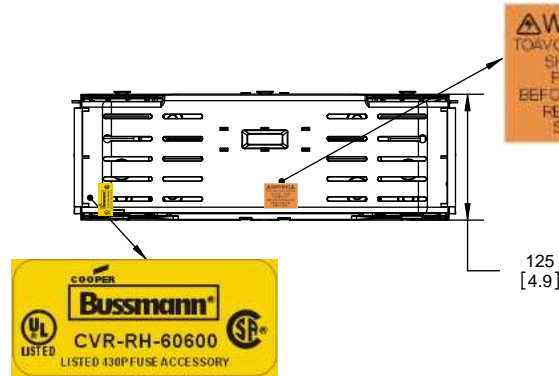

RM60600-1CR WITH CVRI-RH-60600 INSTALLED

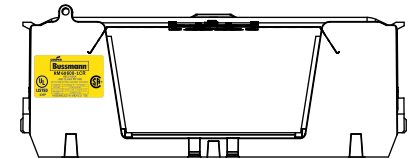
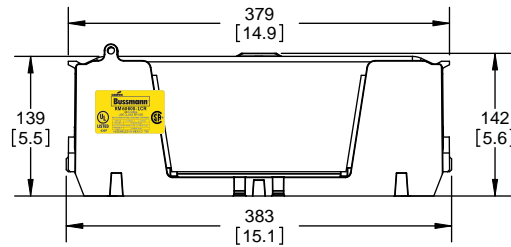
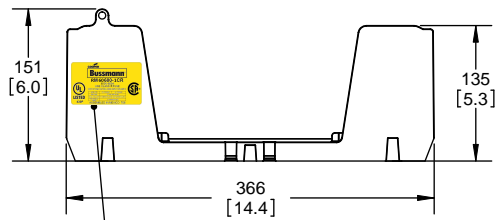
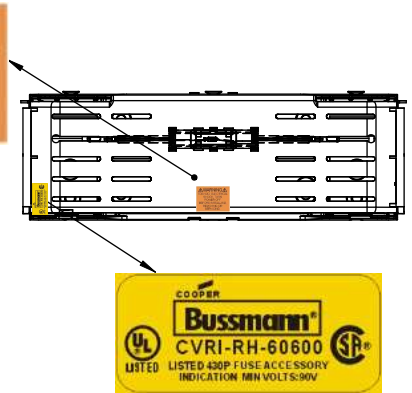

CVR-RH-60600

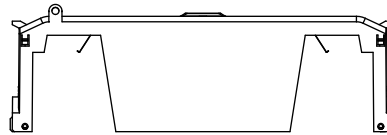

CVRI-RH-60600

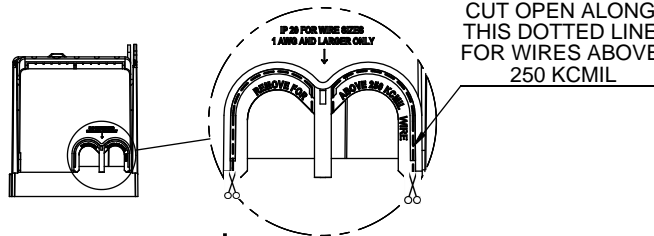
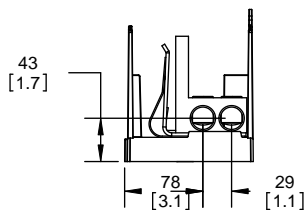
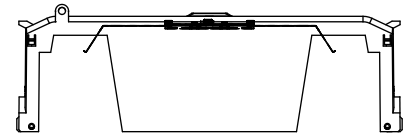

COOPER Bussmann
St. Louis MO 63178

TITLE: **Class R fuse holder-CUST-600V**

SCALE: 1:5 SIZE: A3 SHEET: 10 OF 12

REVISIONS			DATE	ECN	BY
REV	ZONE	DESCRIPTION			

RM60600-2CR



**RM60600-2CR
WITH CVR-RH-60600 INSTALLED**



**RM60600-2CR
WITH CVRI-RH-60600 INSTALLED**

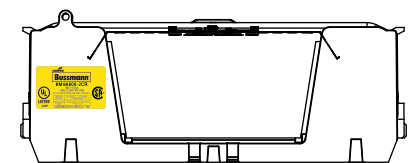
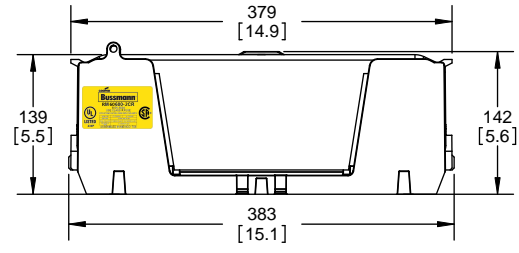

COOPER Bussmann
St. Louis MO 63178

TITLE:
Class R fuse holder-CUST-600V

SCALE: 1:5 SIZE: A3 SHEET: 11 OF 12

REVISIONS				DATE	ECN	BY
REV	ZONE	DESCRIPTION				

RM60600-3CR

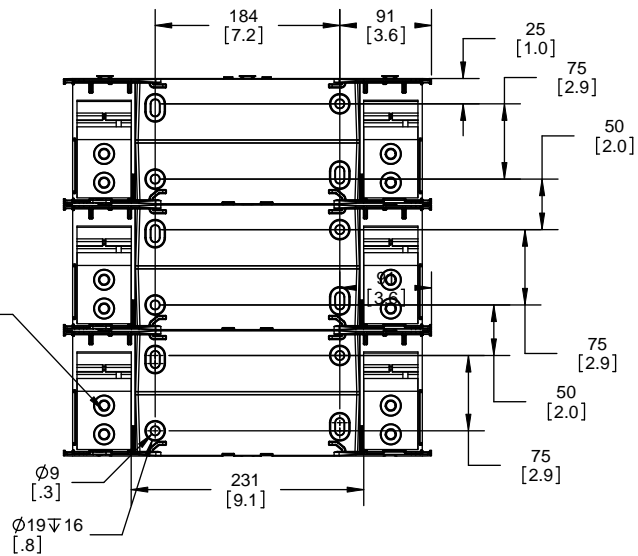

ALLEN KEY #:
3/8" (10.0MM)

**RM60600-3CR
WITH CVR-RH-60600 INSTALLED**

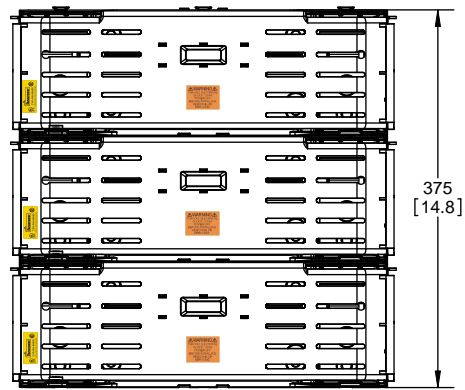

**RM60600-3CR
WITH CVRI-RH-60600 INSTALLED**

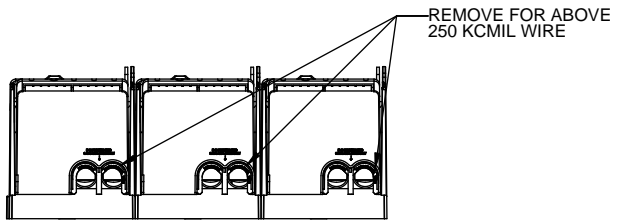
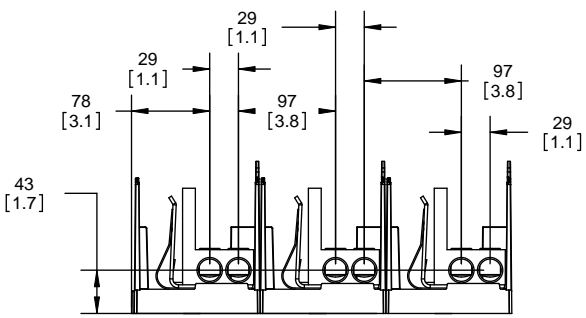
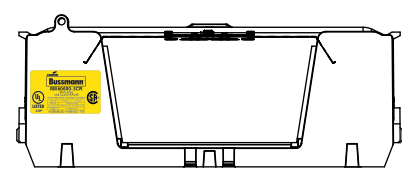
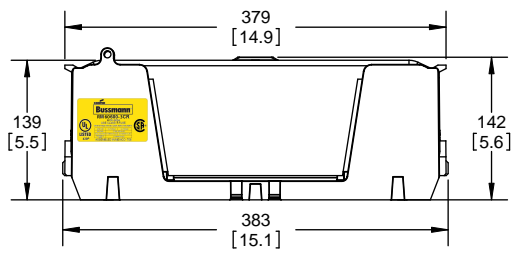
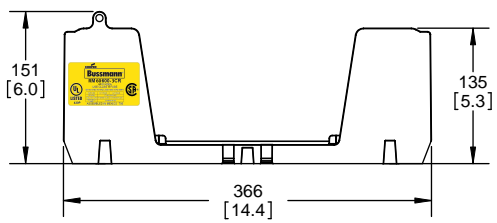
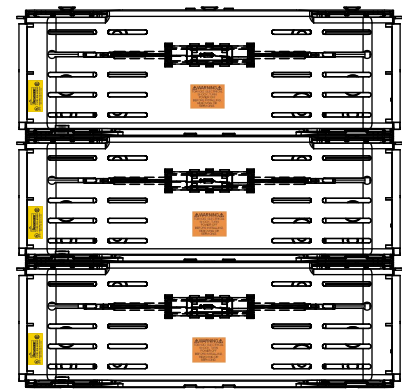

COOPER Bussmann
St. Louis MO 63178

TITLE:
Class R fuse holder-CUST-600V

SCALE: 1:5 SIZE: A3 SHEET: 12 OF 12

Данный компонент на территории Российской Федерации

Вы можете приобрести в компании MosChip.

Для оперативного оформления запроса Вам необходимо перейти по данной ссылке:

<http://moschip.ru/get-element>

Вы можете разместить у нас заказ для любого Вашего проекта, будь то серийное производство или разработка единичного прибора.

В нашем ассортименте представлены ведущие мировые производители активных и пассивных электронных компонентов.

Нашей специализацией является поставка электронной компонентной базы двойного назначения, продукции таких производителей как XILINX, Intel (ex.ALTERA), Vicor, Microchip, Texas Instruments, Analog Devices, Mini-Circuits, Amphenol, Glenair.

Сотрудничество с глобальными дистрибьюторами электронных компонентов, предоставляет возможность заказывать и получать с международных складов практически любой перечень компонентов в оптимальные для Вас сроки.

На всех этапах разработки и производства наши партнеры могут получить квалифицированную поддержку опытных инженеров.

Система менеджмента качества компании отвечает требованиям в соответствии с ГОСТ Р ИСО 9001, ГОСТ РВ 0015-002 и ЭС РД 009

Офис по работе с юридическими лицами:

105318, г.Москва, ул.Щербаковская д.3, офис 1107, 1118, ДЦ «Щербаковский»

Телефон: +7 495 668-12-70 (многоканальный)

Факс: +7 495 668-12-70 (доб.304)

E-mail: info@moschip.ru

Skype отдела продаж:

moschip.ru

moschip.ru_4

moschip.ru_6

moschip.ru_9