

# SERIES 100 SWITCHES

## TOGGLE SWITCHES - MINIATURE



### SPECIFICATIONS

Contact Rating:	See contact material options
Life Expectancy:	40,000 make-and-break cycles
Contact Resistance:	10 mΩ max. typical initial @ 2-4 VDC 100 mA for both silver and gold plated contacts
Insulation Resistance:	1,000 MΩ min.
Dielectric Strength:	1,000 V RMS @ sea level
Operating Temperature:	-30° C to 85° C

### MATERIALS

Case:	Diallyl Phthalate (DAP)
Toggle Handle:	Brass, chrome plated
Switch Support:	Brass or steel, tin plated
Bushing:	Brass, nickel plated
Housing:	Stainless steel
Contacts / Terminals:	Silver or gold plated copper alloy

### FEATURES & BENEFITS

- ▶ Up to 4 poles available
- ▶ Variety of switching functions
- ▶ Miniature
- ▶ Multiple actuator & bushing options

### APPLICATIONS/MARKETS

- ▶ Telecommunications
- ▶ Instrumentation
- ▶ Networking
- ▶ Medical equipment

### HOW TO ORDER

SERIES 100	MODEL NO.	ACTUATOR	BUSHING	TERMINATION	CONTACT MATERIAL	SEAL E	HARDWARE
	SP1	T1†	B1	M1	Q = Silver R = Gold	E = Epoxy Sealed at Base of Terminal	H = Hardware
	SP2*	T2	B2	M2			
	SP3	T3	B3	M3			
	SP4*	T4	B4	M5			
	SP5*	T5	B5	M6			
	DP1	T6	B6	M61			
	DP2*	T7	B8	M7			
	DP3	T8	B9	M71			
	DP4*	T9	B11	VS2			
	DP5*	K1	B12	VS3			
	DP6	K2	B13	VS5*			
	DP7*		B15	M64*			
	DP8*	† Optional Toggle Cap (T1 Only): T100-1 = White T100-2 = Black	B16	VS21*			
	3P1		B25**	VS31*			
	3P2*		B26**				
	3P3						
	3P4*						
	3P5*						
	4P1						
	4P2*						
	4P3						
	4P4*						
	4P5*						
	4P6						
	4P7*						
	4P8*						

▶ ▶ ▶ Example Ordering Number  
100-SP1-T4-B2-M1-R-E

Notes: \* Not available with the K1 and K2 actuator options.

\*\* Available only with the K1 and K2 actuator options.

Specifications subject to change without notice.



### SPDT



SCHEMATIC



Model No.	POS 1	POS 2	POS 3
SP-1	ON	NONE	ON
SP-2	ON	NONE	(ON)
SP-3	ON	OFF	ON
SP-4	(ON)	OFF	(ON)
SP-5	ON	OFF	(ON)
Term. Comm.	2-3	OPEN	2-1

( ) = Momentary

### DPDT



SCHEMATIC



Model No.	POS 1	POS 2	POS 3
DP-1	ON	NONE	ON
DP-2	ON	NONE	(ON)
DP-3	ON	OFF	ON
DP-4	(ON)	OFF	(ON)
DP-5	ON	OFF	(ON)
DP-7	ON	ON	(ON)
DP-8	(ON)	ON	(ON)
Term. Comm.	2-3, 5-6	OPEN	2-1, 5-4

DP-6	ON	ON	ON
Term. Comm.	2-3, 5-6	2-3, 5-4	2-1, 5-4

( ) = Momentary

### 3PDT



SCHEMATIC



Model No.	POS 1	POS 2	POS 3
3P-1	ON	NONE	ON
3P-2	ON	NONE	(ON)
3P-3	ON	OFF	ON
3P-4	(ON)	OFF	(ON)
3P-5	ON	OFF	(ON)
Term. Comm.	2-3, 5-6 8-9	OPEN	2-1, 5-4 8-7

( ) = Momentary

### 4PDT



SCHEMATIC



Model No.	POS 1	POS 2	POS 3
4P-1	ON	NONE	ON
4P-2	ON	NONE	(ON)
4P-3	ON	OFF	ON
4P-4	(ON)	OFF	(ON)
4P-5	ON	OFF	(ON)
4P-7	ON	ON	(ON)
4P-8	(ON)	ON	(ON)
Term. Comm.	2-3, 5-6 8-9 11-12	OPEN	2-1, 5-4 8-7 11-10

4P-6	ON	ON	ON
Term. Comm.	2-3, 5-6 8-9 11-12	2-3, 5-4 8-9 11-10	2-1, 5-4 8-7 11-10

( ) = Momentary

TACT SWITCHES

NAVIGATION SWITCHES

PUSHBUTTON SWITCHES

TOGGLE SWITCHES

ROCKER SWITCHES

SLIDE SWITCHES

SNAP-ACTION SWITCHES

DIP SWITCHES

KEYLOCK SWITCHES

ROTARY SWITCHES

DETECTOR SWITCHES

CAP OPTIONS

# SERIES 100 SWITCHES

## TOGGLE SWITCHES - MINIATURE

### 3 - WAY WIRING DIAGRAM SCHEMATICS



### ACTUATOR OPTIONS



\*Add .070 (1.78) for B3, B4 bushings, subtract .020 (0.51) for B6 bushing.



### BUSHING OPTIONS

**B1 THD STD**

**B2 NON-THD**



**B3 THD STD**

**B4 NON-THD**



B4 is standard for M6, M7 and VS termination options.

**B5 HIGH TORQUE**



**B6 HIGH TORQUE**



**B8 METRIC THD**



**B9 SPLASH PROOF**



**B13**



Use with T7 and T8 actuators only

**B11 THD STD**

**B12 NON-THD**



Use with T6 actuator only

**B15 THD STD**

**B16 NON-THD**



Use with T6 actuator only

**B25**



**B26**



# SERIES 100 SWITCHES

## TOGGLE SWITCHES - MINIATURE

### BUSHING OPTIONS - PANEL MOUNTING



### TERMINATION OPTIONS

#### M2

#### SPDT



#### M1

#### SOLDER LUG

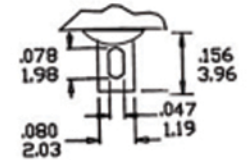

#### M3

#### QUICK CONNECT



#### M2

#### DPDT



#### M5

#### WIRE WRAP

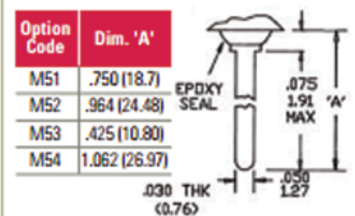

#### M6

#### SPDT

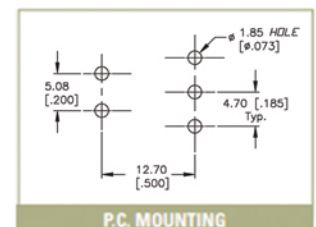
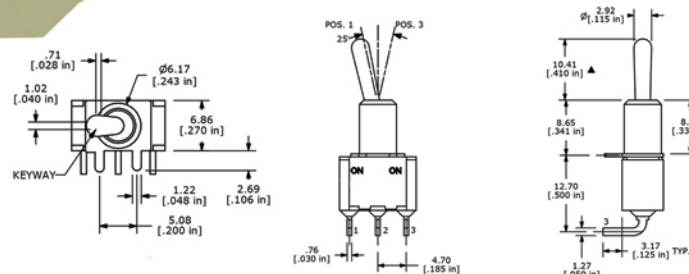



### M6

DPDT



### M7

SPDT

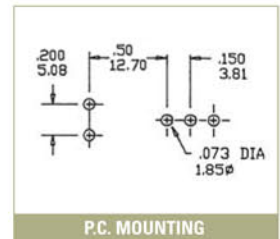

### M7

DPDT

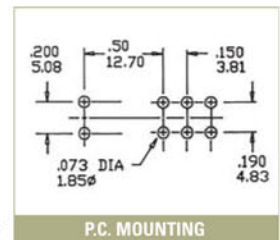

### M7

3PDT

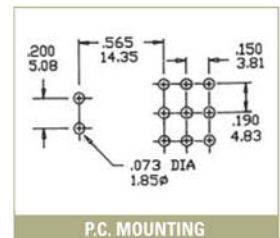
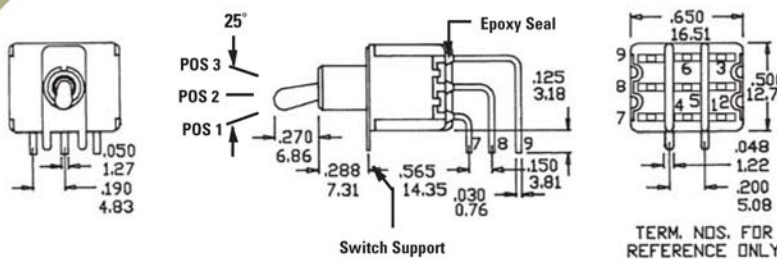

### M7

4PDT

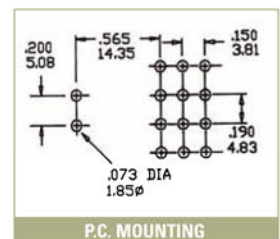
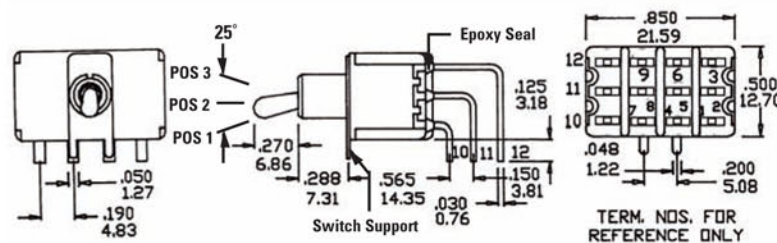

# SERIES 100 SWITCHES

## TOGGLE SWITCHES - MINIATURE

TACT SWITCHES

NAVIGATION SWITCHES

PUSHBUTTON SWITCHES

TOGGLE SWITCHES

ROCKER SWITCHES

SLIDE SWITCHES

SNAP-ACTION SWITCHES

DIP SWITCHES

KEYLOCK SWITCHES

ROTARY SWITCHES

DETECTOR SWITCHES

CAP OPTIONS

### VS2-VS3

SPDT



Option Code	Dim. 'A'
VS2	.460 (11.68)
VS3	.630 (16.00)



P.C. MOUNTING

### VS2-VS3

DPDT



Option Code	Dim. 'A'
VS2	.460 (11.68)
VS3	.630 (16.00)



P.C. MOUNTING

### VS5

DPDT

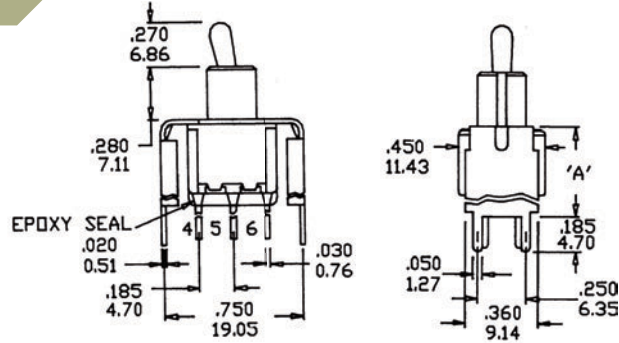

Option Code	Dim. 'A'
VS5	.630 (16.00)



P.C. MOUNTING

### M61

SPDT

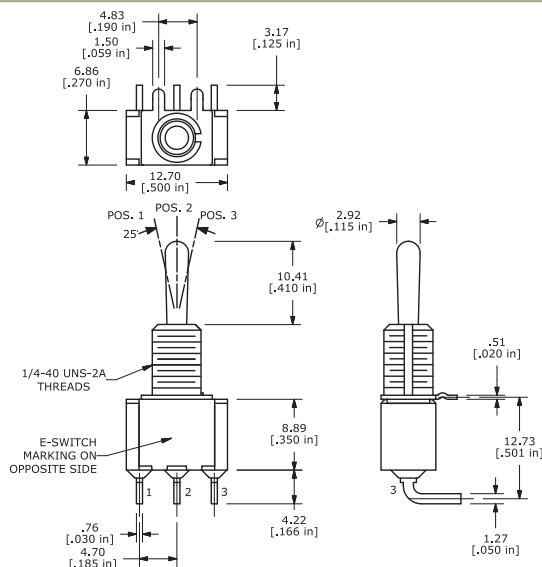

P.C. MOUNTING



### M61

DPDT



### M71

SPDT

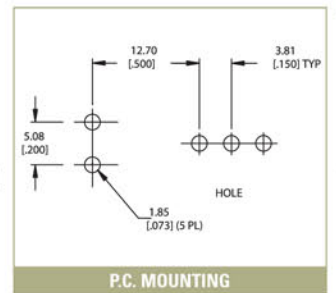

### M64

SPDT



TACT SWITCHES

NAVIGATION SWITCHES

PUSHBUTTON SWITCHES

TOGGLE SWITCHES

ROCKER SWITCHES

SLIDE SWITCHES

SNAP-ACTION SWITCHES

DIP SWITCHES

KEYLOCK SWITCHES

ROTARY SWITCHES

DETECTOR SWITCHES

CAP OPTIONS



# SERIES 100 SWITCHES

## TOGGLE SWITCHES - MINIATURE

### VS21-VS31

SPDT

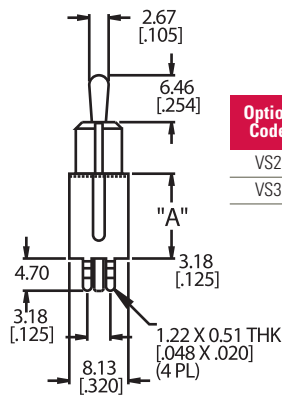
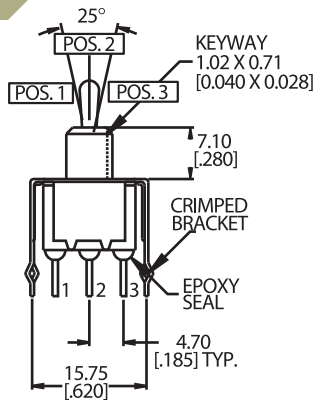

Option Code	Dim. 'A'
VS2	.460 (11.68)
VS3	.630 (16.00)

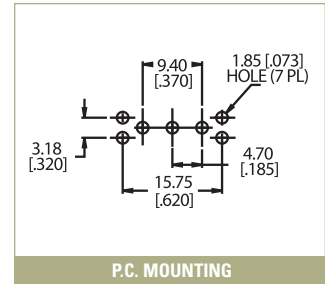

P.C. MOUNTING

### VS21-VS31

DPDT

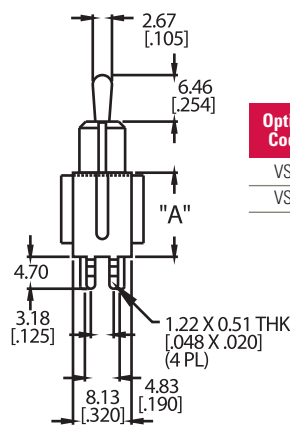
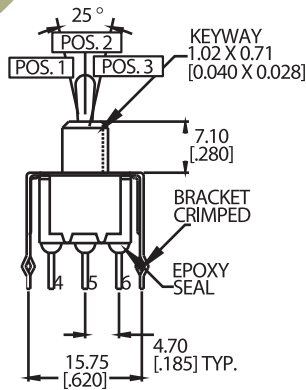

Option Code	Dim. 'A'
VS2	.460 (11.68)
VS3	.630 (16.00)

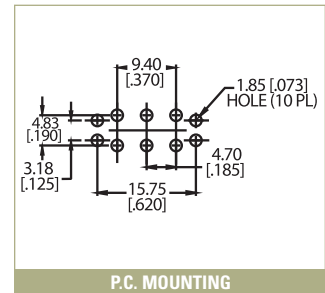

P.C. MOUNTING

### OPTIONAL TOGGLE CAP



Use with T1  
T100-1 WHITE  
T100-2 BLACK



### CONTACT MATERIAL OPTIONS

**Q**

Fixed Terminal:	Silver plated over copper alloy
Moving Contact:	Silver plated over copper alloy
Rating:	5 Amps with resistive load @ 120VAC or 28VDC; 2 Amps with resistive load @ 250VAC

**R**

Fixed Terminal:	Copper alloy with gold plate over nickel plate
Moving Contact:	Copper alloy with gold plate over nickel plate
Rating:	0.4 Volt-Amps (VA) max. @ 20V max. (AC or DC)



**HARDWARE**

**HDW2 1/4 IN. NUTS**

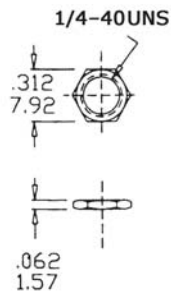

Supplied standard with B1, B3, B5, B6 and B9 options

**HDW3 BLIND DRESSNUT**

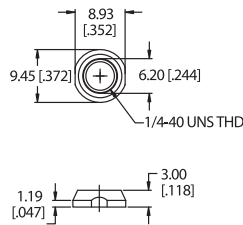

**HDW6 METRIC NUT**

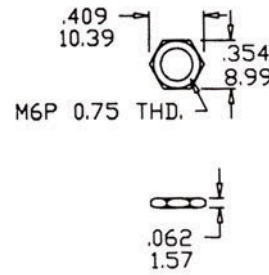

Supplied standard with B8 metric bushing

**HDW11 LOCK WASHER**

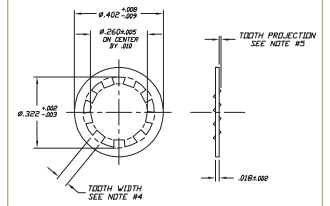

Supplied standard with B1/B3 bushing

**Optional Rubber Hood Sealing E1**

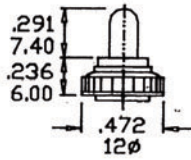

E1= Inch (Std.) for actuator T1, T2 and bushings B1, B3, B5, B6 Optional rubber boot sealing

**HDW4 15/32 IN. NUTS**

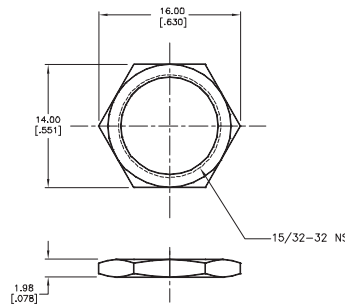

Supplied standard with B13 bushing

**HDW12 LOCK WASHER**

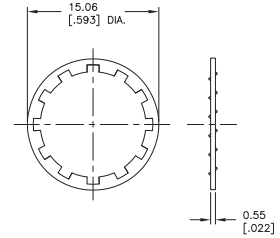

Supplied standard with B13 bushing

**HDW15 LOCKING RING**

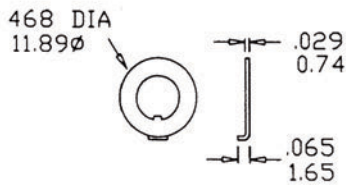

Supplied standard

**HDW16 LOCKING RING**

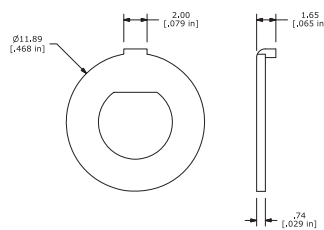

Supplied with B5 bushing

**HDW17 LOCKING RING**

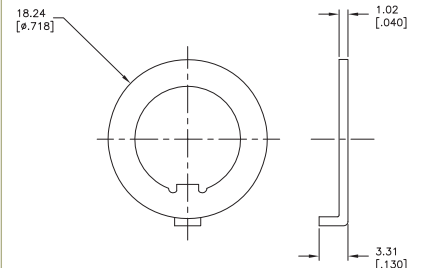

Supplied with B13 bushing

TACT SWITCHES

NAVIGATION SWITCHES

PUSHBUTTON SWITCHES

TOGGLE SWITCHES

ROCKER SWITCHES

SLIDE SWITCHES

SNAP-ACTION SWITCHES

DIP SWITCHES

KEYLOCK SWITCHES

ROTARY SWITCHES

DETECTOR SWITCHES

CAP OPTIONS

## Данный компонент на территории Российской Федерации

### Вы можете приобрести в компании MosChip.

Для оперативного оформления запроса Вам необходимо перейти по данной ссылке:

<http://moschip.ru/get-element>

Вы можете разместить у нас заказ для любого Вашего проекта, будь то серийное производство или разработка единичного прибора.

В нашем ассортименте представлены ведущие мировые производители активных и пассивных электронных компонентов.

Нашей специализацией является поставка электронной компонентной базы двойного назначения, продукции таких производителей как XILINX, Intel (ex.ALTERA), Vicor, Microchip, Texas Instruments, Analog Devices, Mini-Circuits, Amphenol, Glenair.

Сотрудничество с глобальными дистрибьюторами электронных компонентов, предоставляет возможность заказывать и получать с международных складов практически любой перечень компонентов в оптимальные для Вас сроки.

На всех этапах разработки и производства наши партнеры могут получить квалифицированную поддержку опытных инженеров.

Система менеджмента качества компании отвечает требованиям в соответствии с ГОСТ Р ИСО 9001, ГОСТ РВ 0015-002 и ЭС РД 009

### Офис по работе с юридическими лицами:

105318, г.Москва, ул.Щербаковская д.3, офис 1107, 1118, ДЦ «Щербаковский»

Телефон: +7 495 668-12-70 (многоканальный)

Факс: +7 495 668-12-70 (доб.304)

E-mail: [info@moschip.ru](mailto:info@moschip.ru)

Skype отдела продаж:

moschip.ru

moschip.ru\_4

moschip.ru\_6

moschip.ru\_9