

SERIES 100 SWITCHES

TOGGLE SWITCHES - MINIATURE

US



SPECIFICATIONS

| | |
|------------------------|---|
| Contact Rating: | See contact material options |
| Life Expectancy: | 40,000 make-and-break cycles |
| Contact Resistance: | 10 mΩ max. typical initial @ 2-4 VDC 100 mA for both silver and gold plated contacts |
| Insulation Resistance: | 1,000 MΩ min. |
| Dielectric Strength: | 1,000 V RMS @ sea level |
| Operating Temperature: | -30° C to 85° C |

MATERIALS

| | |
|-----------------------|------------------------------------|
| Case: | Diallyl Phthalate (DAP) |
| Toggle Handle: | Brass, chrome plated |
| Switch Support: | Brass or steel, tin plated |
| Bushing: | Brass, nickel plated |
| Housing: | Stainless steel |
| Contacts / Terminals: | Silver or gold plated copper alloy |

FEATURES & BENEFITS

- ▶ Up to 4 poles available
- ▶ Variety of switching functions
- ▶ Miniature
- ▶ Multiple actuator & bushing options

APPLICATIONS/MARKETS

- ▶ Telecommunications
- ▶ Instrumentation
- ▶ Networking
- ▶ Medical equipment

HOW TO ORDER

| SERIES | MODEL NO. | ACTUATOR | BUSHING | TERMINATION | CONTACT MATERIAL | SEAL | HARDWARE |
|--------|--|---|---|--|------------------------|---|--------------|
| 100 | □ □ □ | □ □ | □ □ □ | □ □ □ □ | □ | E | □ |
| | SP1 SP2* SP3 SP4* SP5* DP1 DP2* DP3 DP4* DP5* DP6 DP7* DP8* 3P1 3P2* 3P3 3P4* 3P5* 4P1 4P2* 4P3 4P4* 4P5* 4P6 4P7* 4P8* | T1† T2 T3 T4 T5 T6 T7 T8 T9 K1 K2 † Optional Toggle Cap (T1 Only): T100-1 = White T100-2 = Black | B1 B2 B3 B4 B5 B6 B8 B9 B11 B12 B13 B15 B16 B25** B26** | M1 M2 M3 M5 M6 M61 M7 M71 VS2 VS3 VS5* M64* VS21* VS31* | Q = Silver R = Gold | E = Epoxy Sealed at Base of Terminal | H = Hardware |

▶ ▶ ▶ Example Ordering Number
100-SP1-T4-B2-M1-R-E

Notes: * Not available with the K1 and K2 actuator options.

** Available only with the K1 and K2 actuator options.

Specifications subject to change without notice.



SPDT



SCHEMATIC

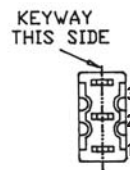

| Model No. | POS 1 | POS 2 | POS 3 |
|-------------|-------|-------|-------|
| SP-1 | ON | NONE | ON |
| SP-2 | ON | NONE | (ON) |
| SP-3 | ON | OFF | ON |
| SP-4 | (ON) | OFF | (ON) |
| SP-5 | ON | OFF | (ON) |
| Term. Comm. | 2-3 | OPEN | 2-1 |

() = Momentary

DPDT

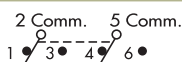

SCHEMATIC

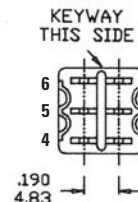
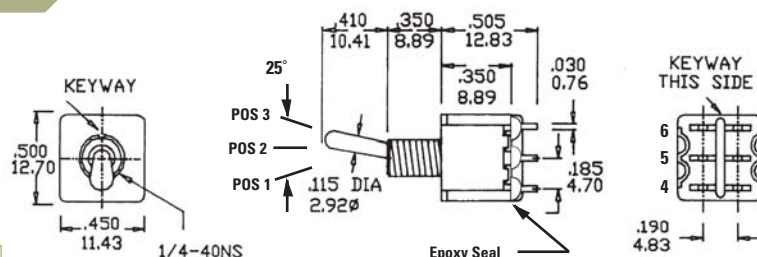

| Model No. | POS 1 | POS 2 | POS 3 |
|-------------|----------|-------|----------|
| DP-1 | ON | NONE | ON |
| DP-2 | ON | NONE | (ON) |
| DP-3 | ON | OFF | ON |
| DP-4 | (ON) | OFF | (ON) |
| DP-5 | ON | OFF | (ON) |
| DP-7 | ON | ON | (ON) |
| DP-8 | (ON) | ON | (ON) |
| Term. Comm. | 2-3, 5-6 | OPEN | 2-1, 5-4 |

| | | | |
|-------------|----------|----------|----------|
| DP-6 | ON | ON | ON |
| Term. Comm. | 2-3, 5-6 | 2-3, 5-4 | 2-1, 5-4 |

() = Momentary

3PDT

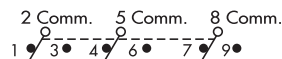

SCHEMATIC

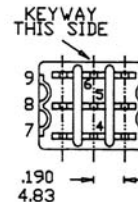
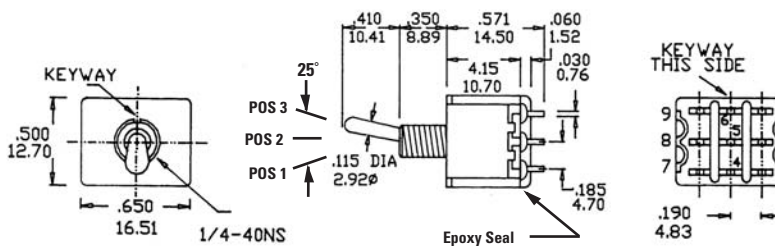

| Model No. | POS 1 | POS 2 | POS 3 |
|-------------|-----------------|-------|-----------------|
| 3P-1 | ON | NONE | ON |
| 3P-2 | ON | NONE | (ON) |
| 3P-3 | ON | OFF | ON |
| 3P-4 | (ON) | OFF | (ON) |
| 3P-5 | ON | OFF | (ON) |
| Term. Comm. | 2-3, 5-6 8-9 | OPEN | 2-1, 5-4 8-7 |

() = Momentary

4PDT

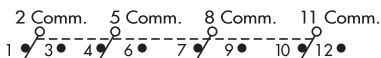

SCHEMATIC

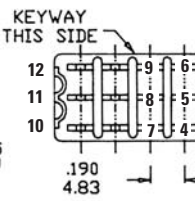
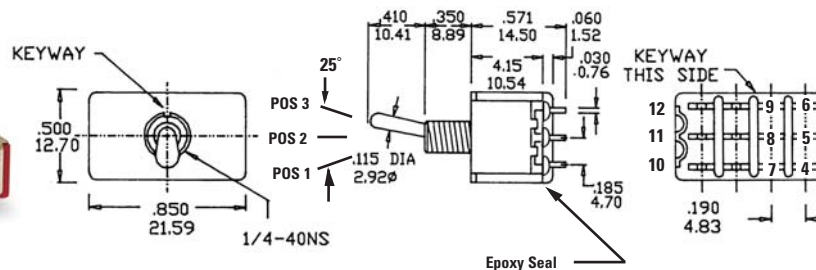

| Model No. | POS 1 | POS 2 | POS 3 |
|-------------|--------------------------|-------|--------------------------|
| 4P-1 | ON | NONE | ON |
| 4P-2 | ON | NONE | (ON) |
| 4P-3 | ON | OFF | ON |
| 4P-4 | (ON) | OFF | (ON) |
| 4P-5 | ON | OFF | (ON) |
| 4P-7 | ON | ON | (ON) |
| 4P-8 | (ON) | ON | (ON) |
| Term. Comm. | 2-3, 5-6 8-9 11-12 | OPEN | 2-1, 5-4 8-7 11-10 |

| | | | |
|-------------|--------------------------|--------------------------|--------------------------|
| 4P-6 | ON | ON | ON |
| Term. Comm. | 2-3, 5-6 8-9 11-12 | 2-3, 5-4 8-9 11-10 | 2-1, 5-4 8-7 11-10 |

() = Momentary

SERIES 100 SWITCHES

TOGGLE SWITCHES - MINIATURE

3 - WAY WIRING DIAGRAM SCHEMATICS



Bottom View
or DP-6, DP-7, DP-8



Bottom View
for 4P-6, 4P-7, 4P-8



ACTUATOR OPTIONS

T1* STANDARD



T2*



T3*



T4*



T5*



T6 FLATTED WITH BUILT IN ANTIROTATION

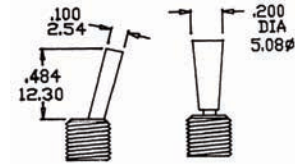

Use with B11, B12, B15, B16 only

T7

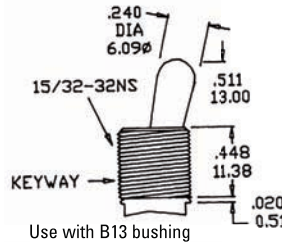

T8



T9* PLASTIC BLACK



K1



K2



*Add .070 (1.78) for B3, B4 bushings, subtract .020 (0.51) for B6 bushing.



BUSHING OPTIONS

B1 THD STD

B2 NON-THD



B3 THD STD

B4 NON-THD



B4 is standard for M6, M7 and VS termination options.

B5 HIGH TORQUE



B6 HIGH TORQUE



B8 METRIC THD

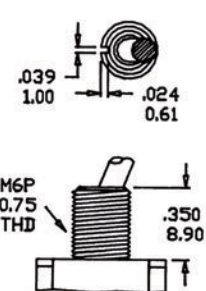

B9 SPLASH PROOF



B13



Use with T7 and T8 actuators only

B11 THD STD

B12 NON-THD

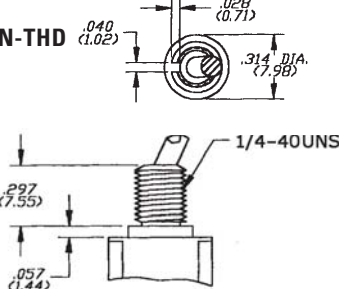

Use with T6 actuator only

B15 THD STD

B16 NON-THD



Use with T6 actuator only

B25

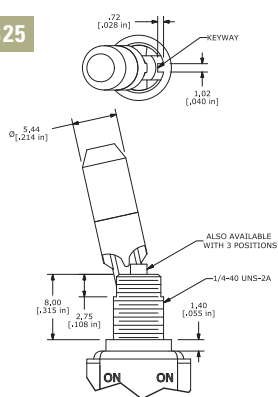

B26

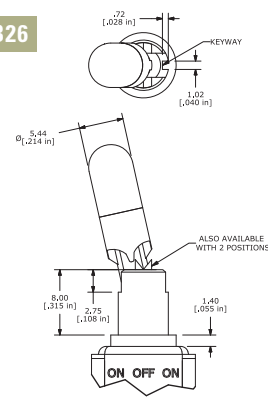

SERIES 100 SWITCHES

TOGGLE SWITCHES - MINIATURE

BUSHING OPTIONS - PANEL MOUNTING

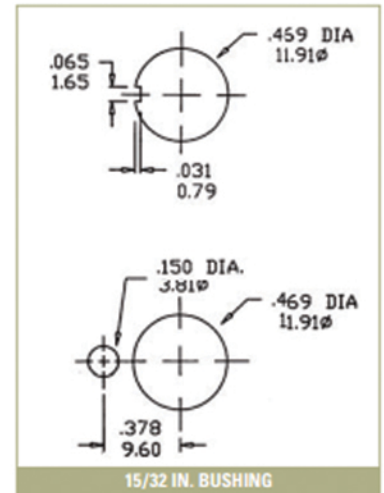
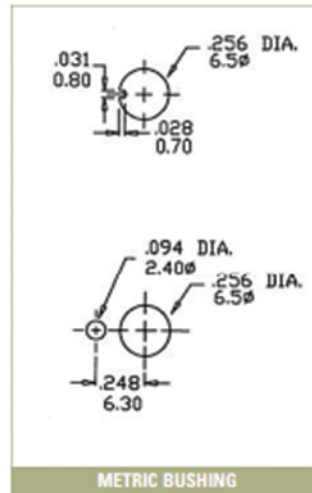
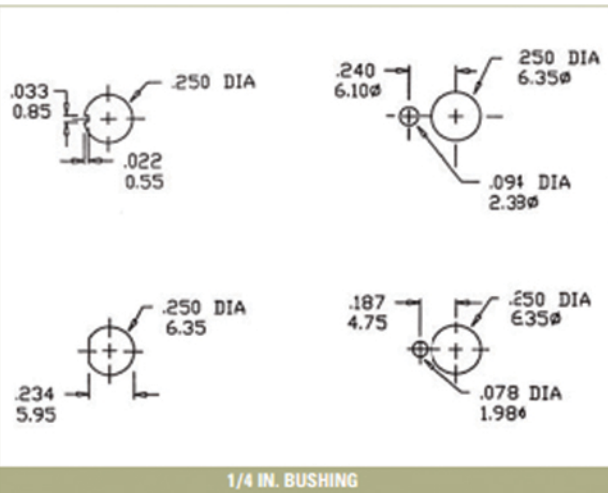

TERMINATION OPTIONS

M2

SPDT

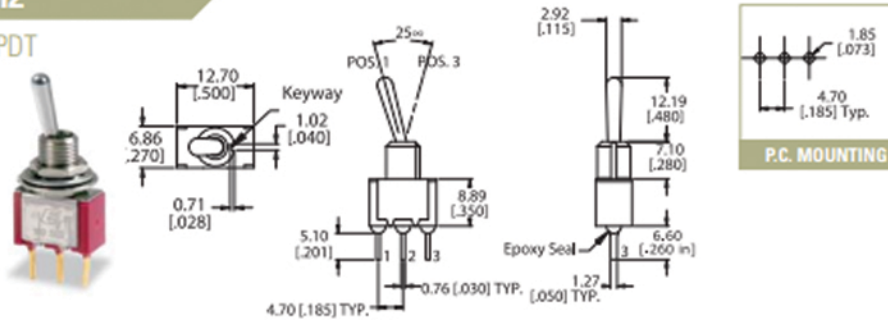

M1 SOLDER LUG

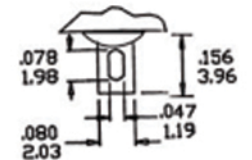

M3 QUICK CONNECT

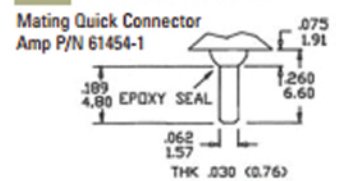

M2

DPDT

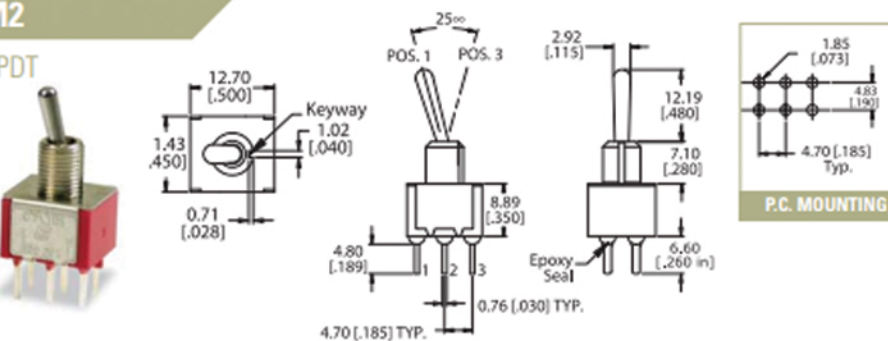

M5 WIRE WRAP

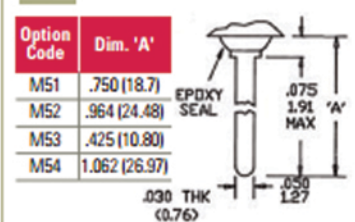

M6

SPDT

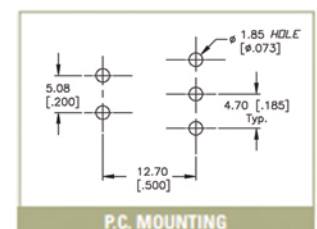
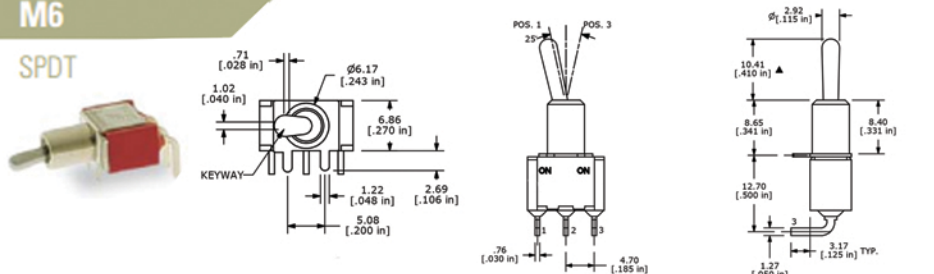



M6

DPDT

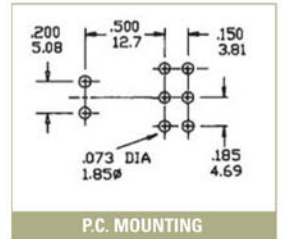
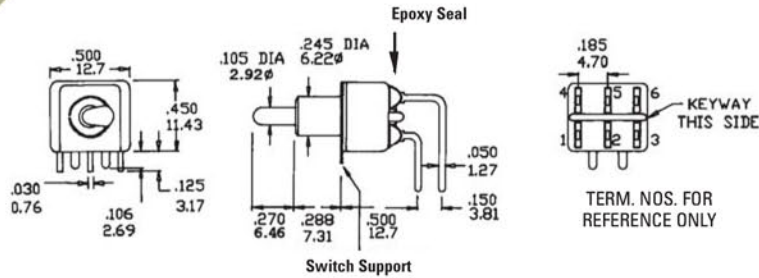

M7

SPDT

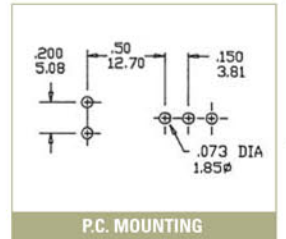
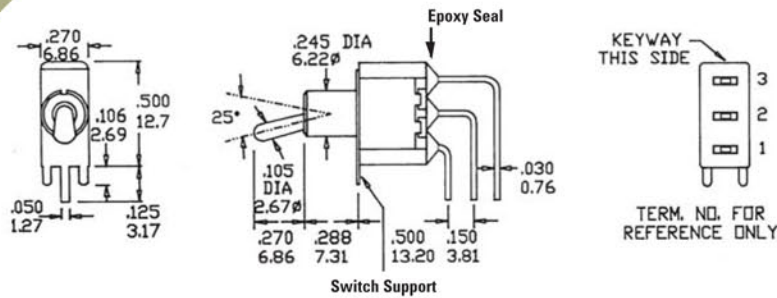

M7

DPDT

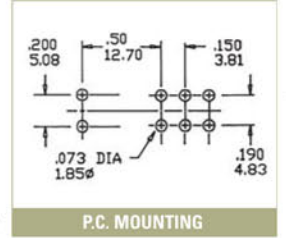
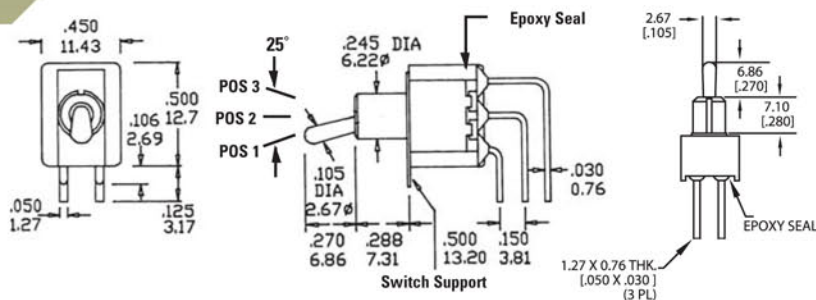

M7

3PDT

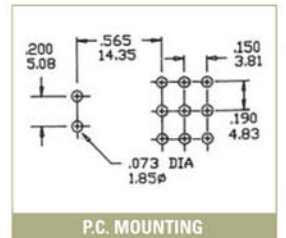
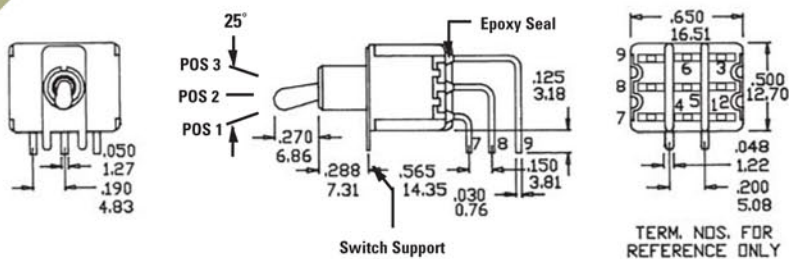

M7

4PDT

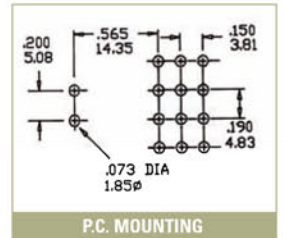
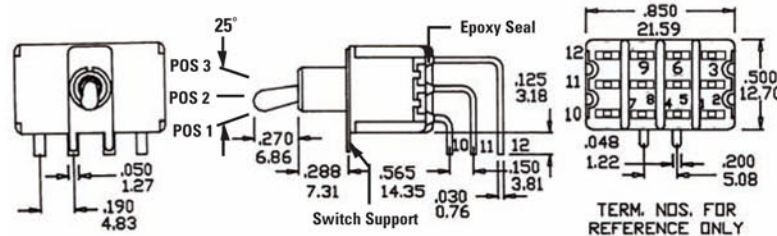

SERIES 100 SWITCHES

TOGGLE SWITCHES - MINIATURE

TACT SWITCHES

NAVIGATION SWITCHES

PUSHBUTTON SWITCHES

TOGGLE SWITCHES

ROCKER SWITCHES

SLIDE SWITCHES

SNAP-ACTION SWITCHES

DIP SWITCHES

KEYLOCK SWITCHES

ROTARY SWITCHES

DETECTOR SWITCHES

CAP OPTIONS

VS2-VS3

SPDT



| Option Code | Dim. 'A' |
|-------------|--------------|
| VS2 | .460 (11.68) |
| VS3 | .630 (16.00) |



P.C. MOUNTING

VS2-VS3

DPDT



| Option Code | Dim. 'A' |
|-------------|--------------|
| VS2 | .460 (11.68) |
| VS3 | .630 (16.00) |



P.C. MOUNTING

VS5

DPDT



| Option Code | Dim. 'A' |
|-------------|--------------|
| VS5 | .630 (16.00) |



P.C. MOUNTING

M61

SPDT

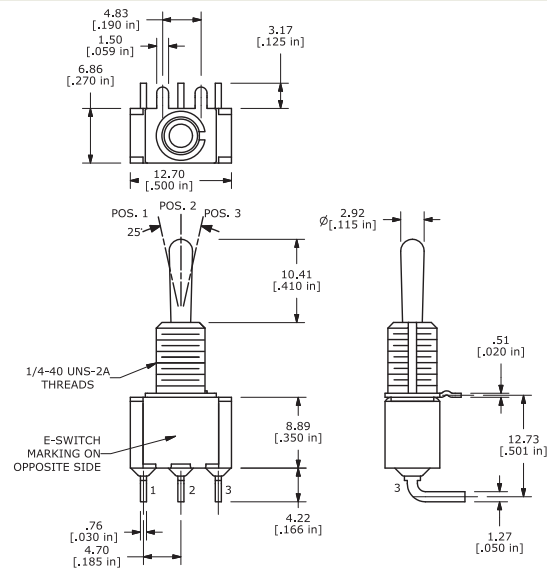

P.C. MOUNTING



M61

DPDT



M71

SPDT



M64

SPDT



TACT SWITCHES

NAVIGATION SWITCHES

PUSHBUTTON SWITCHES

TOGGLE SWITCHES

ROCKER SWITCHES

SLIDE SWITCHES

SNAP-ACTION SWITCHES

DIP SWITCHES

KEYLOCK SWITCHES

ROTARY SWITCHES

DETECTOR SWITCHES

CAP OPTIONS

SERIES 100 SWITCHES

TOGGLE SWITCHES - MINIATURE

VS21-VS31

SPDT



| Option Code | Dim. 'A' |
|-------------|--------------|
| VS2 | .460 (11.68) |
| VS3 | .630 (16.00) |



P.C. MOUNTING

VS21-VS31

DPDT



| Option Code | Dim. 'A' |
|-------------|--------------|
| VS2 | .460 (11.68) |
| VS3 | .630 (16.00) |



P.C. MOUNTING

OPTIONAL TOGGLE CAP



Use with T1
T100-1 WHITE
T100-2 BLACK



CONTACT MATERIAL OPTIONS

Q

| | |
|-----------------|--|
| Fixed Terminal: | Silver plated over copper alloy |
| Moving Contact: | Silver plated over copper alloy |
| Rating: | 5 Amps with resistive load @ 120VAC or 28VDC; 2 Amps with resistive load @ 250VAC |

R

| | |
|-----------------|--|
| Fixed Terminal: | Copper alloy with gold plate over nickel plate |
| Moving Contact: | Copper alloy with gold plate over nickel plate |
| Rating: | 0.4 Volt-Amps (VA) max. @ 20V max. (AC or DC) |



HARDWARE

HDW2 1/4 IN. NUTS



Supplied standard with B1, B3, B5, B6 and B9 options

HDW3 BLIND DRESSNUT



HDW6 METRIC NUT



Supplied standard with B8 metric bushing

HDW11 LOCK WASHER



Supplied standard with B1/B3 bushing

Optional Rubber Hood Sealing E1



E1= Inch (Std.) for actuator T1, T2 and bushings B1, B3, B5, B6 Optional rubber boot sealing

HDW4 15/32 IN. NUTS



Supplied standard with B13 bushing

HDW12 LOCK WASHER



Supplied standard with B13 bushing

HDW15 LOCKING RING



Supplied standard

HDW16 LOCKING RING



Supplied with B5 bushing

HDW17 LOCKING RING



Supplied with B13 bushing

TACT SWITCHES

NAVIGATION SWITCHES

PUSHBUTTON SWITCHES

TOGGLE SWITCHES

ROCKER SWITCHES

SLIDE SWITCHES

SNAP-ACTION SWITCHES

DIP SWITCHES

KEYLOCK SWITCHES

ROTARY SWITCHES

DETECTOR SWITCHES

CAP OPTIONS

Данный компонент на территории Российской Федерации

Вы можете приобрести в компании MosChip.

Для оперативного оформления запроса Вам необходимо перейти по данной ссылке:

<http://moschip.ru/get-element>

Вы можете разместить у нас заказ для любого Вашего проекта, будь то серийное производство или разработка единичного прибора.

В нашем ассортименте представлены ведущие мировые производители активных и пассивных электронных компонентов.

Нашей специализацией является поставка электронной компонентной базы двойного назначения, продукции таких производителей как XILINX, Intel (ex.ALTERA), Vicor, Microchip, Texas Instruments, Analog Devices, Mini-Circuits, Amphenol, Glenair.

Сотрудничество с глобальными дистрибьюторами электронных компонентов, предоставляет возможность заказывать и получать с международных складов практически любой перечень компонентов в оптимальные для Вас сроки.

На всех этапах разработки и производства наши партнеры могут получить квалифицированную поддержку опытных инженеров.

Система менеджмента качества компании отвечает требованиям в соответствии с ГОСТ Р ИСО 9001, ГОСТ РВ 0015-002 и ЭС РД 009

Офис по работе с юридическими лицами:

105318, г.Москва, ул.Щербаковская д.3, офис 1107, 1118, ДЦ «Щербаковский»

Телефон: +7 495 668-12-70 (многоканальный)

Факс: +7 495 668-12-70 (доб.304)

E-mail: info@moschip.ru

Skype отдела продаж:

moschip.ru

moschip.ru_4

moschip.ru_6

moschip.ru_9