

3-Phase Brushless Sinusoidal Sensorless Motor Driver

Features:

- Automotive AEC-Q100 Qualified, PPAP Available Upon Request
- Position Sensorless BLDC Drivers (No Hall Sensor Required)
- 180° Sinusoidal Drive for High Efficiency and Low Acoustic Noise
- Supports 2V to 14V Power Supplies
- Speed Control through PSM (Power Supply Modulation) and/or PWM (Pulse-Width Modulation)
- Built-in Frequency Generator (FG Output Signal)
- Built-in Lock-up Protection and Automatic Recovery Circuit (External Capacitor not Necessary)
- Built-in Overcurrent Limitation (1.5A)
- Built-in Thermal Shutdown Protection
- Thermally Enhanced 8L 4x4 DFN Package with Exposed Pad
- 23 kHz PWM Output Frequency
- No External Tuning Required
- Optimized for Fan Cooling Systems

Typical Applications:

- Silent Notebook CPU/GPU Cooling Fans
- Air Ventilation System
- 12V 3-Phase BLDC Motors

Description:

The MCP8063 device is a highly integrated 3-phase, full-wave sensorless driver for brushless motors. It features a 180° sinusoidal drive, high torque output, and silent drive. Its integrated features and the wide power supply range (2V to 14V) make the MCP8063 an ideal candidate for a broad range of motor characteristics, requiring no external tuning. Speed control can be achieved through either power supply modulation (PSM) or pulse-width modulation (PWM).

Due to the compact packaging and minimum bill of materials (power transistors integrated, no Hall sensor, no external tuning), the MCP8063 is optimized for fan applications that require high efficiency and low acoustic noise at competitive costs. Frequency generator output enables precision speed control in closed-loop applications. The MCP8063 driver includes a Lock-up Protection mode, which turns off the output current when the motor is under lock condition, and an automatic recovery that enables the fan to restart when the lock condition is removed. Features such as motor overcurrent limitation and thermal shutdown protection improve motor system reliability without additional efforts from design engineers.

The MCP8063 is available in a compact thermally-enhanced 8L 4x4 DFN package with Exposed Pad.

Package Types

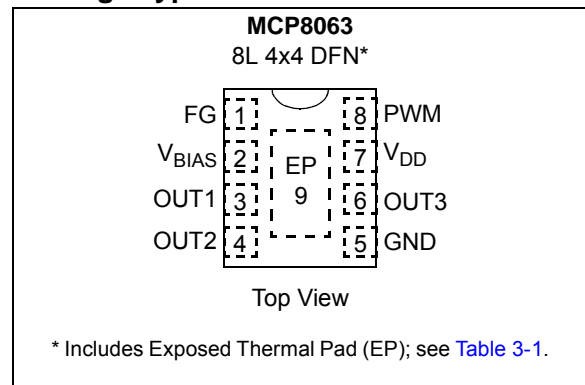

MCP8063

Functional Block Diagram

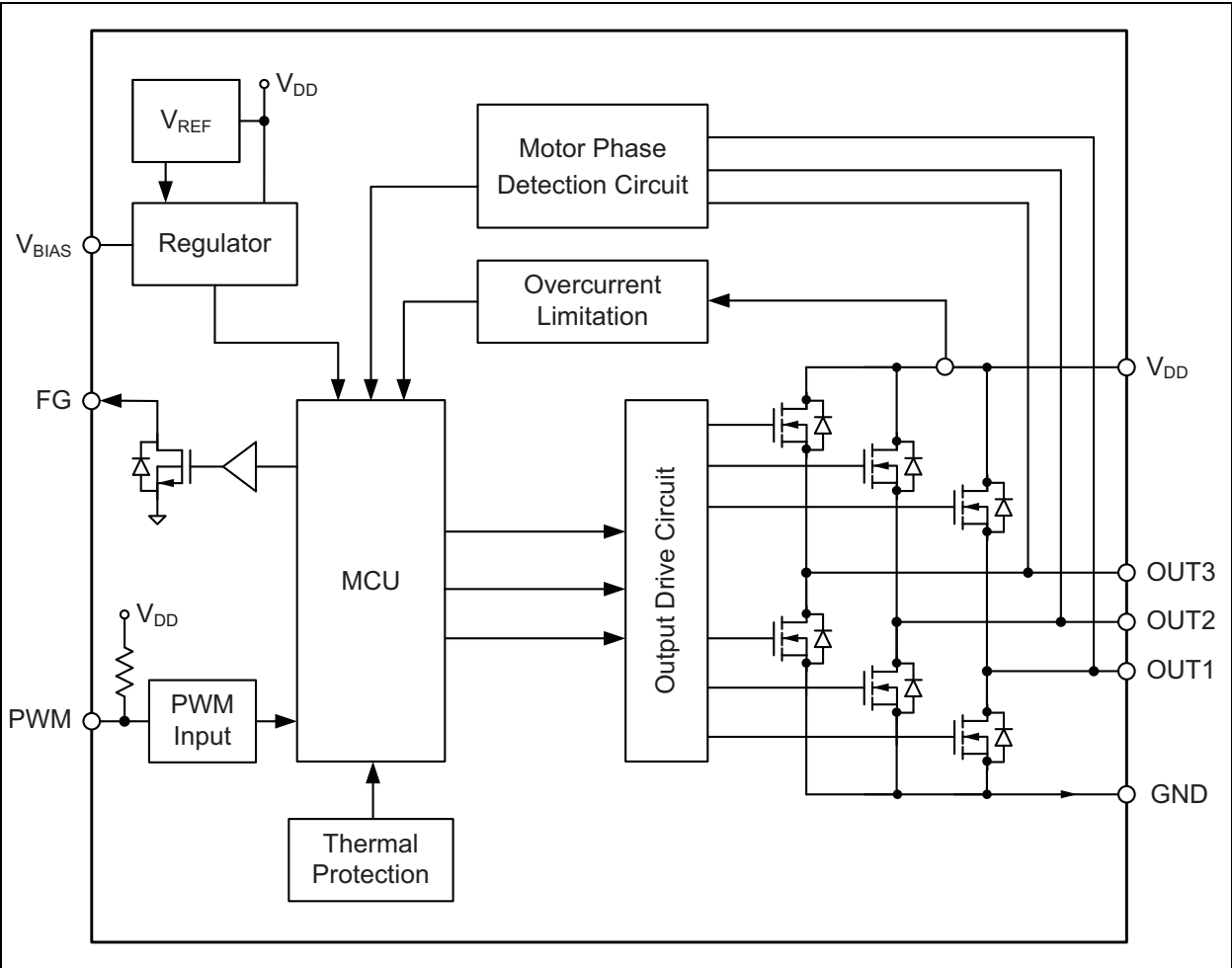

Typical Application – Fan Motor Driver Using the MCP8063

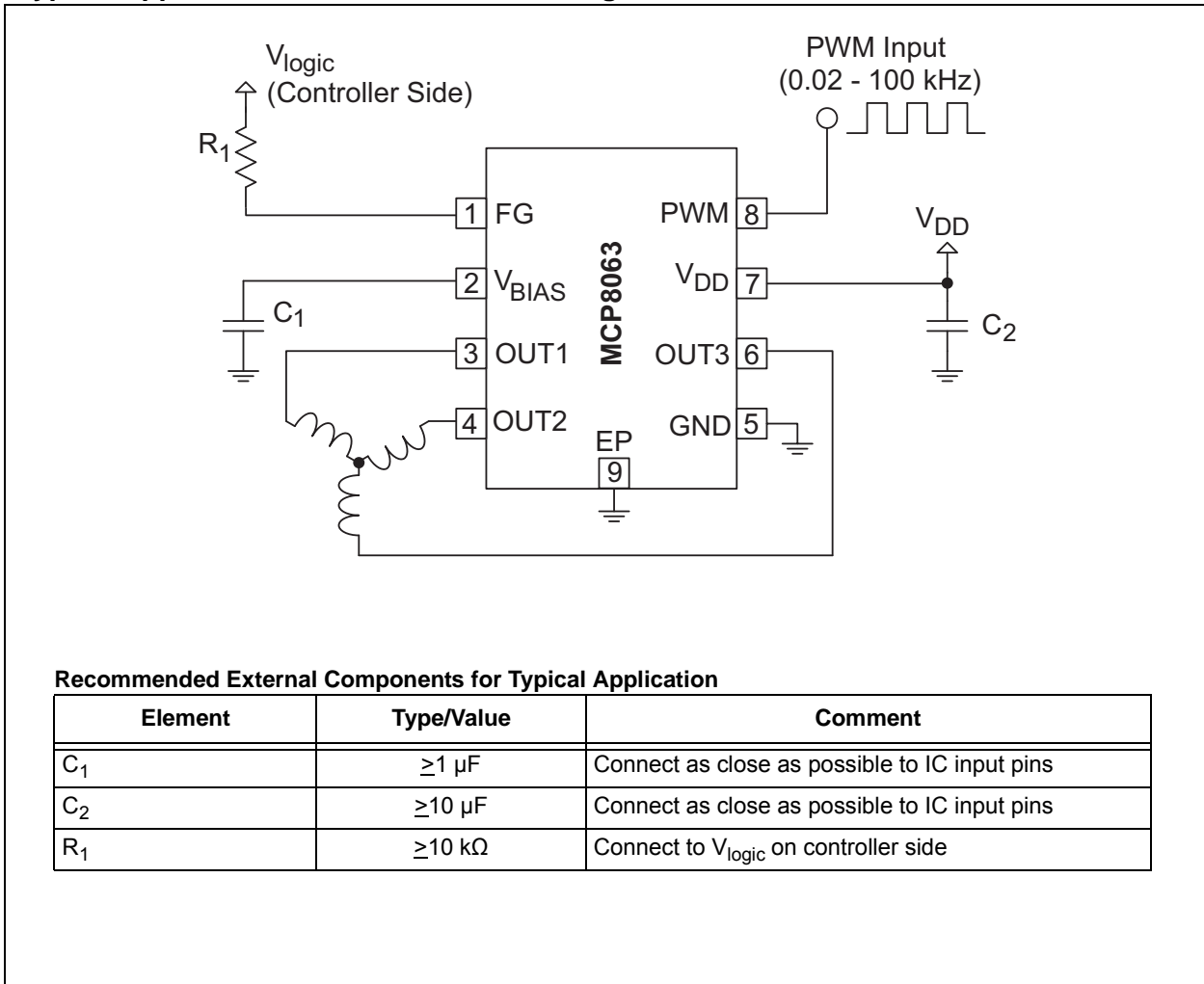

MCP8063

1.0 ELECTRICAL CHARACTERISTICS

Absolute Maximum Ratings†

Power Supply Voltage (V_{DD_MAX})	-0.7 to +15.3V
Maximum OUT1,2,3 Voltage (V_{OUT_MAX})	-0.7 to +16.0V
Maximum Output Current ⁽³⁾ (I_{OUT_MAX})	-1.7A to +1.7A
FG Maximum Output Voltage (V_{FG_MAX})	-0.7 to +15.3V
FG Maximum Output Current (I_{FG_MAX})	5.0 mA
V_{BIAS} Maximum Voltage (V_{BIAS_MAX})	-0.7 to +4.0V
PWM Maximum Voltage (V_{PWM_MAX})	-0.7 to +4.0V
Max Junction Temperature (T_J)	+150°C
HBM ESD protection on all pins	4 kV

† **Notice:** Stresses above those listed under “Maximum Ratings” may cause permanent damage to the device. This is a stress rating only and functional operation of the device at those or any other conditions above those indicated in the operational listings of this specification is not implied. Exposure to maximum rating conditions for extended periods may affect device reliability.

Note 1: Reference PCB, according to JEDEC standard EIA/JESD 51-9.

2: Derating applies for ambient temperatures outside the specified operating range (refer to [Figure 1-1](#)).

3: OUT1, OUT2, OUT3 (Continuous, 100% duty cycle).

ELECTRICAL CHARACTERISTICS

Electrical Specifications: Unless otherwise specified, all limits are established for $V_{DD} = 12.0V$, Temperature = +25°C.						
Parameters	Sym.	Min.	Typ.	Max.	Units	Conditions
Power Supply Voltage	V_{DD}	2	—	14	V	
Power Supply Current	I_{VDD}	—	10	—	mA	Rotation Mode
			5			Lock-Protection Mode
OUT1/2/3 High Resistance	$R_{ON(H)}$	—	0.6	1	Ω	$I_{OUT} = 0.5A$, $V_{DD} = 3.3V$ to 14V (Note 1)
OUT1/2/3 Low Resistance	$R_{ON(L)}$	—	0.6	1	Ω	$I_{OUT} = -0.5A$, $V_{DD} = 3.3V$ to 14V (Note 1)
OUT1/2/3 Total Resistance	$R_{ON(H+L)}$	—	1.2	2	Ω	$I_{OUT} = 0.5A$, $V_{DD} = 3.3V$ to 14V (Note 1)
OUT1/2/3 Maximum Current Limitation	I_{OUT_LIM}	1.4	1.5	1.6	A	Note 1
V_{BIAS} Output Voltage	V_{BIAS}	—	3	—	V	$V_{DD} = 3.3V$ to 14V
			$V_{DD} - 0.2$		V	$V_{DD} < 3.3V$
PWM Input Frequency	f_{PWM}	0.02	—	100	kHz	—
PWM Input H Level	V_{PWM_H}	$0.8 \cdot V_{BIAS}$	—	3.6	V	—
PWM Input L Level	V_{PWM_L}	0	—	$0.2 \cdot V_{BIAS}$	V	—
PWM Internal Pull-Up Current	I_{PWM_L}	17	34	—	μA	PWM = GND, $V_{DD} = 3.3V$ to 14V
			8	17	—	μA
PWM Output Frequency	f_{PWM_O}	—	23	—	kHz	
FG Output Pin Low Level Voltage	V_{OL_FG}	—	—	0.25	V	$I_{FG} = -1$ mA
FG Output Pin Leakage Current	I_{LH_FG}	—	—	10	μA	$V_{FG} = 14V$
Lock Protection Operating Time	T_{RUN}	—	0.5	—	s	—
Lock Protection Waiting Time	T_{WAIT}	4.0	4.5	5.0	s	—
Thermal Shutdown	T_{SD}	—	170	—	°C	—
Thermal Shutdown Hysteresis	T_{SD_HYS}	—	25	—	°C	—

Note 1: Minimum and maximum parameter is not production tested and is specified by design and validation.

TEMPERATURE SPECIFICATIONS

Electrical Specifications: Unless otherwise specified, all limits are established for $V_{DD} = 12.0V$, $T_A = +25^\circ C$.						
Parameters	Sym.	Min.	Typ.	Max.	Units	Conditions
Temperature Ranges						
Operating Temperature	T_{OPR}	-40	—	+125	$^\circ C$	
Storage Temperature Range	T_{STG}	-55	—	+150	$^\circ C$	
Package Thermal Resistances						
Thermal Resistance, 8L 4x4 DFN	θ_{JA}	—	48	—	$^\circ C/W$	
	θ_{JC}	—	7	—	$^\circ C/W$	

Note 1: Minimum and maximum parameter is not production tested and is specified by design and validation.

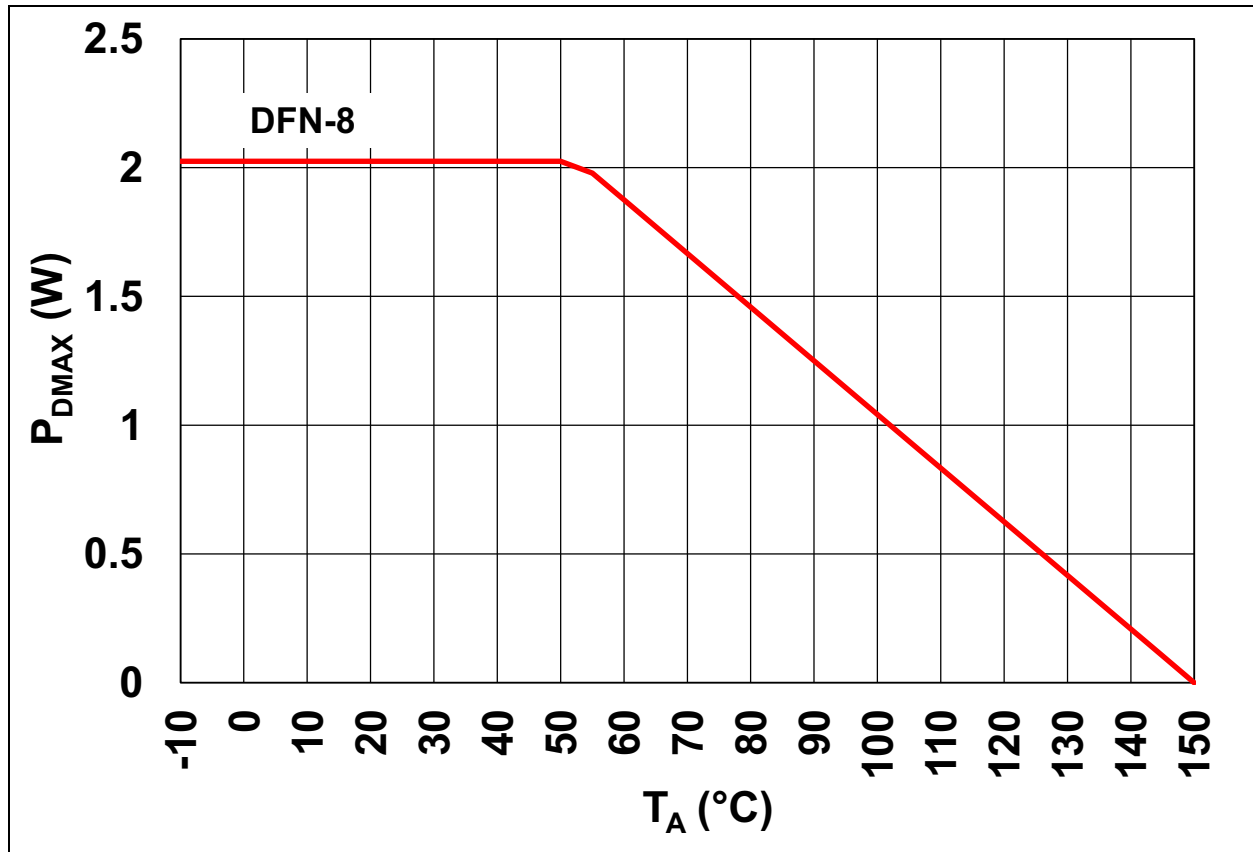

FIGURE 1-1: Allowable Power Dissipation ($P_{D_{MAX}}$) as a Function of Ambient Temperature (T_A).

MCP8063

2.0 TYPICAL PERFORMANCE CURVES

Note: The graphs and tables provided following this note are a statistical summary based on a limited number of samples and are provided for informational purposes only. The performance characteristics listed herein are not tested or guaranteed. In some graphs or tables, the data presented may be outside the specified operating range (e.g., outside specified power supply range) and therefore outside the warranted range.

Note: Unless otherwise indicated, $T_A = +25^\circ\text{C}$, $V_{DD} = 14\text{V}$, OUT1, 2, 3 and PWM open.

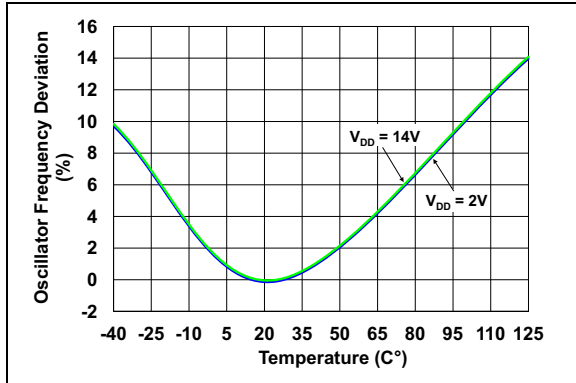

FIGURE 2-1: Oscillator Frequency Deviation vs. Temperature.

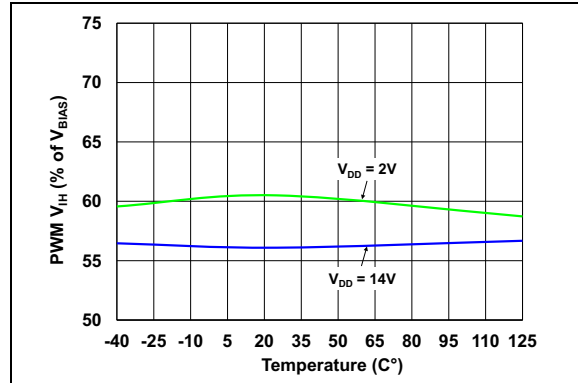

FIGURE 2-4: Input (PWM) V_{IH} vs. Temperature.

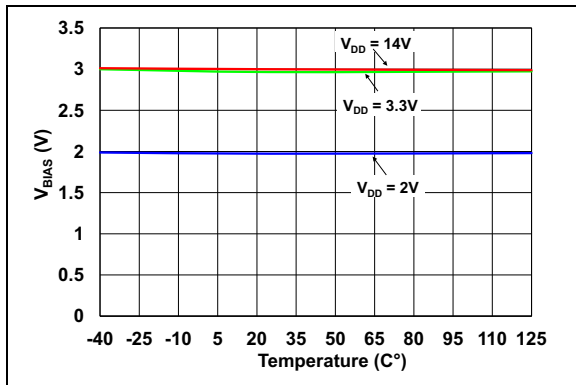

FIGURE 2-2: Internal Regulated Voltage (V_{BIAS}) vs. Temperature.

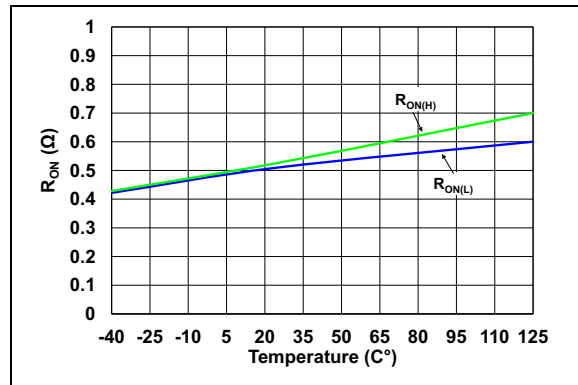

FIGURE 2-5: Output R_{ON} Resistance vs. Temperature ($V_{DD} = 3.3\text{V}$).

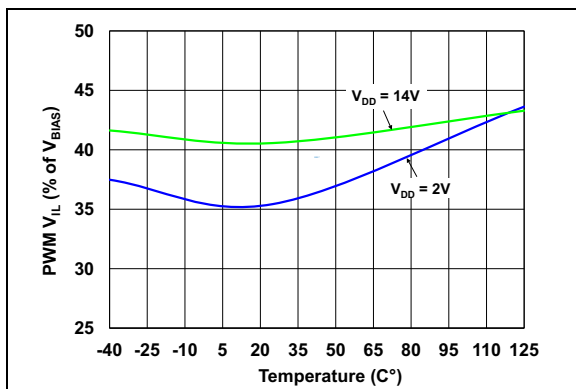

FIGURE 2-3: Input (PWM) V_{IL} vs. Temperature.

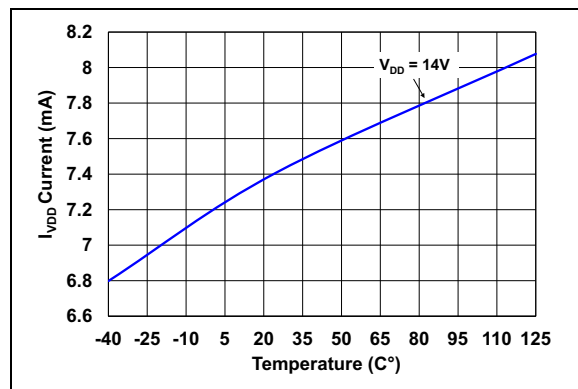

FIGURE 2-6: Supply Current vs. Temperature.

Note: Unless otherwise indicated, $T_A = +25^\circ\text{C}$, $V_{DD} = 14\text{V}$, OUT1, 2, 3 and PWM open.

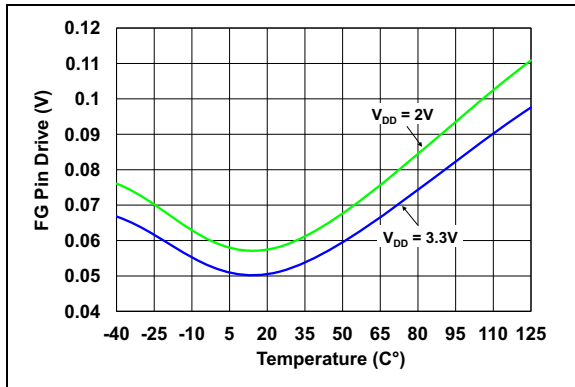

FIGURE 2-7: FG Output Pin Low Level Voltage ($I_{FG} = -1\text{ mA}$).

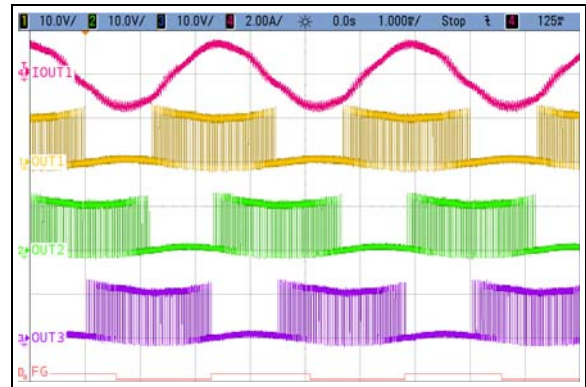

FIGURE 2-10: Typical Outputs on Closed Loop.

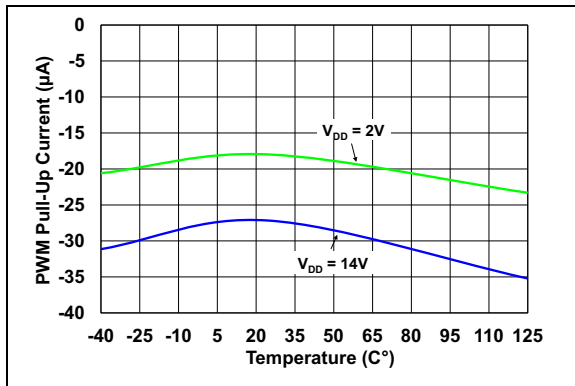

FIGURE 2-8: PWM Pull-Up Current vs. Temperature.

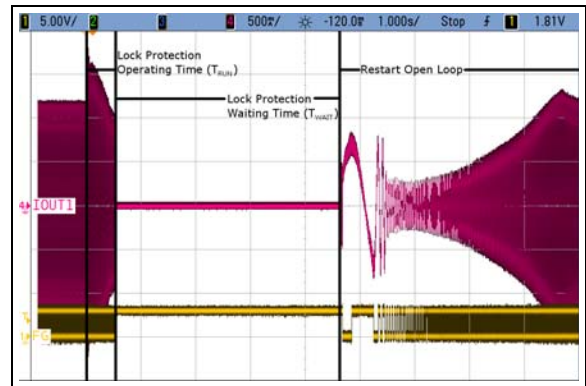

FIGURE 2-11: Typical Rotor Lock Situation.

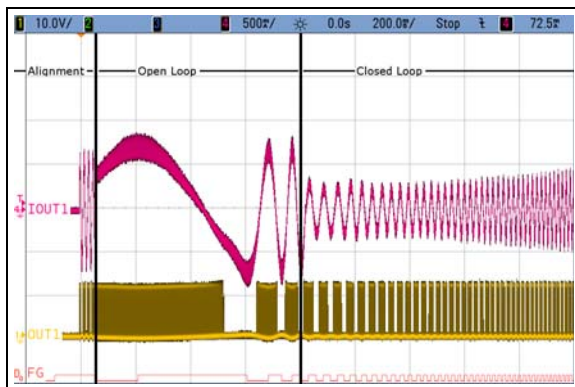

FIGURE 2-9: Typical Output on Start-up.

MCP8063

3.0 PIN DESCRIPTIONS

The descriptions of the pins are listed in [Table 3-1](#).

TABLE 3-1: MCP8063 PIN FUNCTION TABLE

MCP8063	Type	Symbol	Description
4x4 DFN			
1	O	FG	Motor speed indication output
2	P	V _{BIAS}	Internal regulator output (for decoupling only)
3	O	OUT1	Single-phase coil output pin
4	O	OUT2	Single-phase coil output pin
5	P	GND	Negative voltage supply (ground)
6	O	OUT3	Single-phase coil output pin
7	P	V _{DD}	Positive voltage supply for motor driver
8	I	PWM	PWM input signal for speed control
9	P	EP	Exposed pad is used for thermal dissipation. Connect to GND

Legend: I = Input; O = Output; P = Power

4.0 FUNCTIONAL DESCRIPTION

The MCP8063 devices generate a full-wave signal to drive a 3-phase sensorless BLDC motor. High efficiency and low power consumption are achieved due to DMOS transistors and synchronous rectification drive type. The current carrying order of the output is as follows: OUT1 → OUT2 → OUT3.

4.1 Speed Control

The rotational speed of the motor can be controlled either through the PWM digital input signal or by varying the power supply (V_{DD}). When the PWM signal is “High” (or left open), the motor rotates at full speed. When the PWM signal is “Low”, the motor is stopped (and the driver outputs are set to high impedance). By changing the PWM duty cycle, the speed can be adjusted. Notice that the PWM frequency has no special meaning for the motor speed and is asynchronous with the activation of the output transistors. Thus, the user has maximum freedom to choose the PWM system frequency within a wide range (from 20 Hz to 100 kHz), while the output transistor activation always occurs at a fixed rate, which is outside the range of audible frequencies. The typical output frequency of MCP8063 is 23 kHz.

4.2 Frequency Generator Function

The Frequency Generator output is a “Hall-sensor equivalent” digital output, giving information to an external controller about the speed and phase of the motor. The FG pin is an open-drain output, connecting to a logical voltage level through an external pull-up resistor. When a lock (or out-of-sync) situation is detected by the driver, this output is set to high impedance until the motor is restarted. Leave the pin open when not used. The FG signal can be used to compute the motor speed in rotations per minute (RPM). Typically, for a four-pole BLDC fan (4P/6S), the speed in RPMs is $30 \times \text{FG frequency (Hz)}$.

EQUATION 1-1:

$$\frac{FG \times 720}{(P \times S)} = \text{Rotor speed RPM}$$

Where:

P = Total number of poles in the motor

S = Total number of slots in the motor

4.3 Lock-up Protection and Automatic Restart

If the motor is stopped (blocked) or if it loses synchronization with the driver, a lock-up protection circuit detects this situation and ties the outputs to GND in order to dissipate the remaining energy from the rotor with a minimum of self heating. After a “waiting time” (T_{WAIT}), the lock-up protection is released and normal operation resumes for a given time (T_{RUN}). In case the motor is still blocked, a new period of waiting time is started. T_{WAIT} and T_{RUN} timings are fixed internally, so that no external capacitor is needed.

4.4 Overcurrent Limitation

The motor peak current is limited by the driver to a fixed value (defined internally), thus limiting the maximum power dissipation in the coils.

4.5 Thermal Shutdown

The MCP8063 has a thermal protection function which detects when the die temperature exceeds $T_{SD} = +170^{\circ}\text{C}$. When this temperature is reached, the circuit enters Thermal Shutdown mode and the outputs OUT1, OUT2 and OUT3 are tied to GND in order to dissipate the remaining energy from the rotor with a minimum of self heating. Once the junction temperature (T_{SD}) has dropped below $+145^{\circ}\text{C}$, the normal operation resumes (the thermal detection circuit has $+25^{\circ}\text{C}$ hysteresis function).

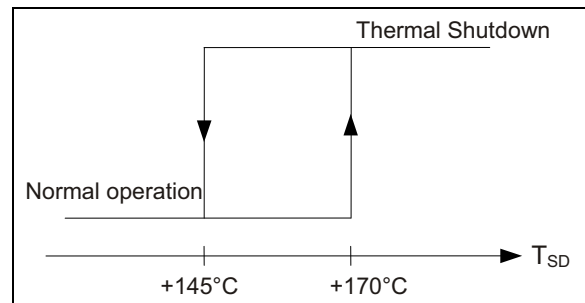

FIGURE 4-1: Thermal Protection Hysteresis.

4.6 Internal Voltage Regulator

V_{BIAS} voltage is generated internally and is used to supply internal logical blocks. The V_{BIAS} pin is used to connect an external decoupling capacitor ($1 \mu\text{F}$ or higher). Notice that this pin is for IC internal use and is not designed to supply DC current to external blocks.

MCP8063

5.0 PACKAGING INFORMATION

5.1 Package Marking Information

8-Lead DFN (4x4x0.9 mm)

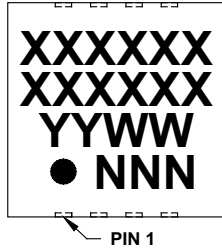

Example

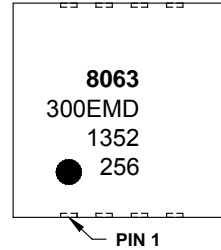

Legend:	XX...X	Customer-specific information
	Y	Year code (last digit of calendar year)
	YY	Year code (last 2 digits of calendar year)
	WW	Week code (week of January 1 is week '01')
	NNN	Alphanumeric traceability code
	(e3)	Pb-free JEDEC designator for Matte Tin (Sn)
	*	This package is Pb-free. The Pb-free JEDEC designator (e3) can be found on the outer packaging for this package.
Note:	In the event the full Microchip part number cannot be marked on one line, it will be carried over to the next line, thus limiting the number of available characters for customer-specific information.	

8-Lead Plastic Dual Flat, No Lead Package (MD) – 4x4x0.9 mm Body [DFN]

Note: For the most current package drawings, please see the Microchip Packaging Specification located at <http://www.microchip.com/packaging>

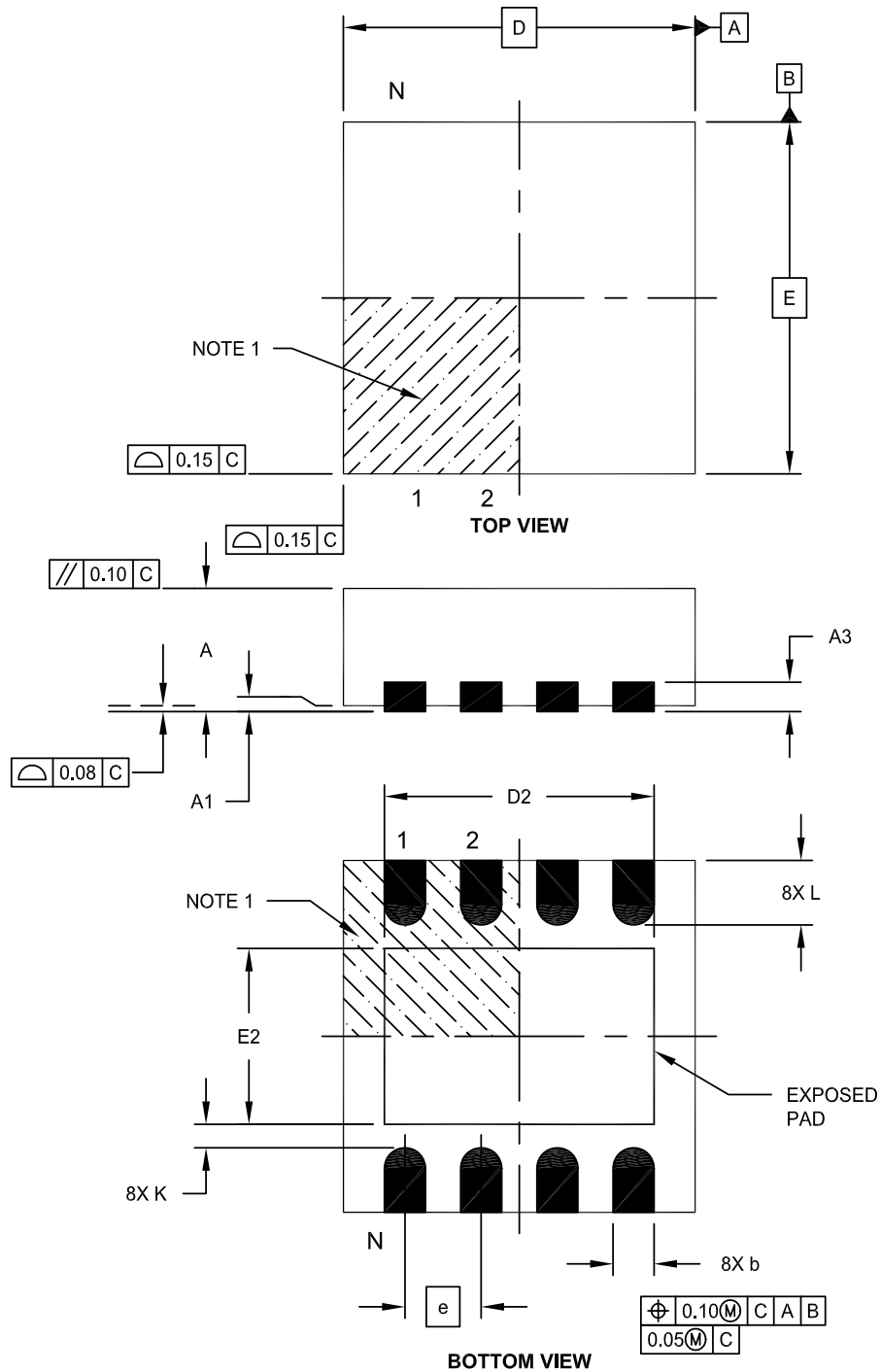

Microchip Technology Drawing C04-131E Sheet 1 of 2

MCP8063

8-Lead Plastic Dual Flat, No Lead Package (MD) – 4x4x0.9 mm Body [DFN]

Note: For the most current package drawings, please see the Microchip Packaging Specification located at <http://www.microchip.com/packaging>

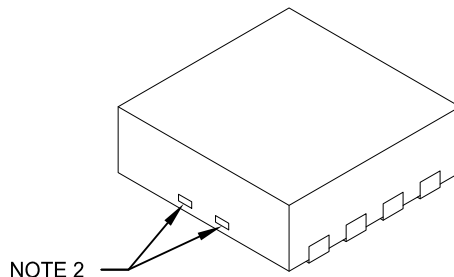

Dimension Limits	Units	MILLIMETERS		
		MIN	NOM	MAX
Number of Pins	N	8		
Pitch	e	0.80 BSC		
Overall Height	A	0.80	0.90	1.00
Standoff	A1	0.00	0.02	0.05
Contact Thickness	A3	0.20 REF		
Overall Length	D	4.00 BSC		
Exposed Pad Width	E2	2.60	2.70	2.80
Overall Width	E	4.00 BSC		
Exposed Pad Length	D2	3.40	3.50	3.60
Contact Width	b	0.25	0.30	0.35
Contact Length	L	0.30	0.40	0.50
Contact-to-Exposed Pad	K	0.20	-	-

Notes:

1. Pin 1 visual index feature may vary, but must be located within the hatched area.
2. Package may have one or more exposed tie bars at ends.
3. Package is saw singulated
4. Dimensioning and tolerancing per ASME Y14.5M
BSC: Basic Dimension. Theoretically exact value shown without tolerances.
REF: Reference Dimension, usually without tolerance, for information purposes only.

Microchip Technology Drawing C04-131E Sheet 2 of 2

8-Lead Plastic Dual Flat, No Lead Package (MD) - 4x4x0.9 mm Body [DFN]

Note: For the most current package drawings, please see the Microchip Packaging Specification located at <http://www.microchip.com/packaging>

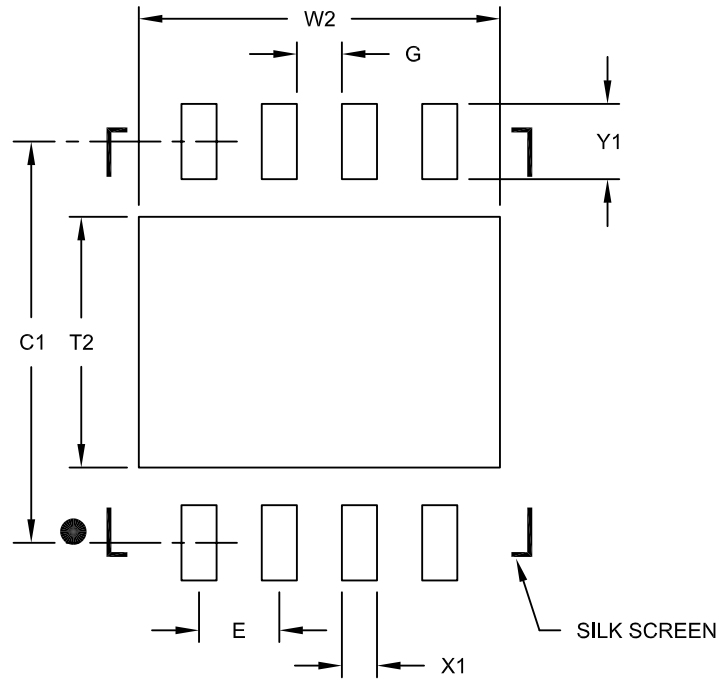

RECOMMENDED LAND PATTERN

Dimension Limits	Units	MILLIMETERS		
		MIN	NOM	MAX
Contact Pitch	E	0.80 BSC		
Optional Center Pad Width	W2			3.60
Optional Center Pad Length	T2			2.50
Contact Pad Spacing	C1	4.00		
Contact Pad Width (X8)	X1			0.35
Contact Pad Length (X8)	Y1			0.75
Distance Between Pads	G	0.45		

Notes:

1. Dimensioning and tolerancing per ASME Y14.5M

BSC: Basic Dimension. Theoretically exact value shown without tolerances.

Microchip Technology Drawing No. C04-2131C

MCP8063

NOTES:

APPENDIX A: REVISION HISTORY

Revision A (February 2014)

- Original Release of this Document.

MCP8063

NOTES:

PRODUCT IDENTIFICATION SYSTEM

To order or obtain information, e.g., on pricing or delivery, refer to the factory or the listed sales office.

<u>PART NO.</u>	<u>X</u>	<u>-X</u>	<u>XX</u>
Device	Tube/Tape and Reel	Temperature Range	Package
Device:	MCP8063:	3-Phase BLDC Sinusoidal Sensorless Motor Driver	
	MCP8063T:	3-Phase BLDC Sinusoidal Sensorless Motor Driver (Tape and Reel)	
Temperature Range:	E	= -40°C to +125°C (Extended)	
Package:	MD	= 8-Lead Plastic Dual Flat, No Lead – 4x4x0.9 mm Body (DFN)	

Examples:

- a) MCP8063-E/MD: Extended temperature, 8LD 4x4 DFN package
- b) MCP8063T-E/MD: Tape and Reel, Extended temperature, 8LD 4x4 DFN package

MCP8063

NOTES:

Note the following details of the code protection feature on Microchip devices:

- Microchip products meet the specification contained in their particular Microchip Data Sheet.
- Microchip believes that its family of products is one of the most secure families of its kind on the market today, when used in the intended manner and under normal conditions.
- There are dishonest and possibly illegal methods used to breach the code protection feature. All of these methods, to our knowledge, require using the Microchip products in a manner outside the operating specifications contained in Microchip's Data Sheets. Most likely, the person doing so is engaged in theft of intellectual property.
- Microchip is willing to work with the customer who is concerned about the integrity of their code.
- Neither Microchip nor any other semiconductor manufacturer can guarantee the security of their code. Code protection does not mean that we are guaranteeing the product as “unbreakable.”

Code protection is constantly evolving. We at Microchip are committed to continuously improving the code protection features of our products. Attempts to break Microchip's code protection feature may be a violation of the Digital Millennium Copyright Act. If such acts allow unauthorized access to your software or other copyrighted work, you may have a right to sue for relief under that Act.

Information contained in this publication regarding device applications and the like is provided only for your convenience and may be superseded by updates. It is your responsibility to ensure that your application meets with your specifications. MICROCHIP MAKES NO REPRESENTATIONS OR WARRANTIES OF ANY KIND WHETHER EXPRESS OR IMPLIED, WRITTEN OR ORAL, STATUTORY OR OTHERWISE, RELATED TO THE INFORMATION, INCLUDING BUT NOT LIMITED TO ITS CONDITION, QUALITY, PERFORMANCE, MERCHANTABILITY OR FITNESS FOR PURPOSE. Microchip disclaims all liability arising from this information and its use. Use of Microchip devices in life support and/or safety applications is entirely at the buyer's risk, and the buyer agrees to defend, indemnify and hold harmless Microchip from any and all damages, claims, suits, or expenses resulting from such use. No licenses are conveyed, implicitly or otherwise, under any Microchip intellectual property rights.

Trademarks

The Microchip name and logo, the Microchip logo, dsPIC, FlashFlex, KEELOQ, KEELOQ logo, MPLAB, PIC, PICmicro, PICSTART, PIC³² logo, rPIC, SST, SST Logo, SuperFlash and UNI/O are registered trademarks of Microchip Technology Incorporated in the U.S.A. and other countries.

FilterLab, Hampshire, HI-TECH C, Linear Active Thermistor, MTP, SEEVAL and The Embedded Control Solutions Company are registered trademarks of Microchip Technology Incorporated in the U.S.A.

Silicon Storage Technology is a registered trademark of Microchip Technology Inc. in other countries.

Analog-for-the-Digital Age, Application Maestro, BodyCom, chipKIT, chipKIT logo, CodeGuard, dsPICDEM, dsPICDEM.net, dsPICworks, dsSPEAK, ECAN, ECONOMONITOR, FanSense, HI-TIDE, In-Circuit Serial Programming, ICSP, Mindi, MiWi, MPASM, MPF, MPLAB Certified logo, MPLIB, MPLINK, mTouch, Omniclient Code Generation, PICC, PICC-18, PICDEM, PICDEM.net, PICkit, PICtail, REAL ICE, rLAB, Select Mode, SQI, Serial Quad I/O, Total Endurance, TSHARC, UniWinDriver, WiperLock, ZENA and Z-Scale are trademarks of Microchip Technology Incorporated in the U.S.A. and other countries.

SQTP is a service mark of Microchip Technology Incorporated in the U.S.A.

GestIC and ULPP are registered trademarks of Microchip Technology Germany II GmbH & Co. KG, a subsidiary of Microchip Technology Inc., in other countries.

All other trademarks mentioned herein are property of their respective companies.

© 2014, Microchip Technology Incorporated, Printed in the U.S.A., All Rights Reserved.

 Printed on recycled paper.

ISBN: 978-1-62077-910-1

Microchip received ISO/TS-16949:2009 certification for its worldwide headquarters, design and wafer fabrication facilities in Chandler and Tempe, Arizona; Gresham, Oregon and design centers in California and India. The Company's quality system processes and procedures are for its PIC[®] MCUs and dsPIC[®] DSCs, KEELOQ[®] code hopping devices, Serial EEPROMs, microperipherals, nonvolatile memory and analog products. In addition, Microchip's quality system for the design and manufacture of development systems is ISO 9001:2000 certified.

QUALITY MANAGEMENT SYSTEM
CERTIFIED BY DNV
== ISO/TS 16949 ==



MICROCHIP

Worldwide Sales and Service

AMERICAS

Corporate Office
2355 West Chandler Blvd.
Chandler, AZ 85224-6199
Tel: 480-792-7200
Fax: 480-792-7277
Technical Support:
<http://www.microchip.com/support>
Web Address:
www.microchip.com

Atlanta
Duluth, GA
Tel: 678-957-9614
Fax: 678-957-1455

Austin, TX
Tel: 512-257-3370

Boston
Westborough, MA
Tel: 774-760-0087
Fax: 774-760-0088

Chicago
Itasca, IL
Tel: 630-285-0071
Fax: 630-285-0075

Cleveland
Independence, OH
Tel: 216-447-0464
Fax: 216-447-0643

Dallas
Addison, TX
Tel: 972-818-7423
Fax: 972-818-2924

Detroit
Novi, MI
Tel: 248-848-4000

Houston, TX
Tel: 281-894-5983

Indianapolis
Noblesville, IN
Tel: 317-773-8323
Fax: 317-773-5453

Los Angeles
Mission Viejo, CA
Tel: 949-462-9523
Fax: 949-462-9608

New York, NY
Tel: 631-435-6000

San Jose, CA
Tel: 408-735-9110

Canada - Toronto
Tel: 905-673-0699
Fax: 905-673-6509

ASIA/PACIFIC

Asia Pacific Office
Suites 3707-14, 37th Floor
Tower 6, The Gateway
Harbour City, Kowloon
Hong Kong
Tel: 852-2401-1200
Fax: 852-2401-3431

Australia - Sydney
Tel: 61-2-9868-6733
Fax: 61-2-9868-6755

China - Beijing
Tel: 86-10-8569-7000
Fax: 86-10-8528-2104

China - Chengdu
Tel: 86-28-8665-5511
Fax: 86-28-8665-7889

China - Chongqing
Tel: 86-23-8980-9588
Fax: 86-23-8980-9500

China - Hangzhou
Tel: 86-571-2819-3187
Fax: 86-571-2819-3189

China - Hong Kong SAR
Tel: 852-2943-5100
Fax: 852-2401-3431

China - Nanjing
Tel: 86-25-8473-2460
Fax: 86-25-8473-2470

China - Qingdao
Tel: 86-532-8502-7355
Fax: 86-532-8502-7205

China - Shanghai
Tel: 86-21-5407-5533
Fax: 86-21-5407-5066

China - Shenyang
Tel: 86-24-2334-2829
Fax: 86-24-2334-2393

China - Shenzhen
Tel: 86-755-8864-2200
Fax: 86-755-8203-1760

China - Wuhan
Tel: 86-27-5980-5300
Fax: 86-27-5980-5118

China - Xian
Tel: 86-29-8833-7252
Fax: 86-29-8833-7256

China - Xiamen
Tel: 86-592-2388138
Fax: 86-592-2388130

China - Zhuhai
Tel: 86-756-3210040
Fax: 86-756-3210049

ASIA/PACIFIC

India - Bangalore
Tel: 91-80-3090-4444
Fax: 91-80-3090-4123

India - New Delhi
Tel: 91-11-4160-8631
Fax: 91-11-4160-8632

India - Pune
Tel: 91-20-3019-1500

Japan - Osaka
Tel: 81-6-6152-7160
Fax: 81-6-6152-9310

Japan - Tokyo
Tel: 81-3-6880-3770
Fax: 81-3-6880-3771

Korea - Daegu
Tel: 82-53-744-4301
Fax: 82-53-744-4302

Korea - Seoul
Tel: 82-2-554-7200
Fax: 82-2-558-5932 or
82-2-558-5934

Malaysia - Kuala Lumpur
Tel: 60-3-6201-9857
Fax: 60-3-6201-9859

Malaysia - Penang
Tel: 60-4-227-8870
Fax: 60-4-227-4068

Philippines - Manila
Tel: 63-2-634-9065
Fax: 63-2-634-9069

Singapore
Tel: 65-6334-8870
Fax: 65-6334-8850

Taiwan - Hsin Chu
Tel: 886-3-5778-366
Fax: 886-3-5770-955

Taiwan - Kaohsiung
Tel: 886-7-213-7830

Taiwan - Taipei
Tel: 886-2-2508-8600
Fax: 886-2-2508-0102

Thailand - Bangkok
Tel: 66-2-694-1351
Fax: 66-2-694-1350

EUROPE

Austria - Wels
Tel: 43-7242-2244-39
Fax: 43-7242-2244-393

Denmark - Copenhagen
Tel: 45-4450-2828
Fax: 45-4485-2829

France - Paris
Tel: 33-1-69-53-63-20
Fax: 33-1-69-30-90-79

Germany - Dusseldorf
Tel: 49-2129-3766400

Germany - Munich
Tel: 49-89-627-144-0
Fax: 49-89-627-144-44

Germany - Pforzheim
Tel: 49-7231-424750

Italy - Milan
Tel: 39-0331-742611
Fax: 39-0331-466781

Italy - Venice
Tel: 39-049-7625286

Netherlands - Drunen
Tel: 31-416-690399
Fax: 31-416-690340

Poland - Warsaw
Tel: 48-22-3325737

Spain - Madrid
Tel: 34-91-708-08-90
Fax: 34-91-708-08-91

Sweden - Stockholm
Tel: 46-8-5090-4654

UK - Wokingham
Tel: 44-118-921-5800
Fax: 44-118-921-5820

Данный компонент на территории Российской Федерации

Вы можете приобрести в компании MosChip.

Для оперативного оформления запроса Вам необходимо перейти по данной ссылке:

<http://moschip.ru/get-element>

Вы можете разместить у нас заказ для любого Вашего проекта, будь то серийное производство или разработка единичного прибора.

В нашем ассортименте представлены ведущие мировые производители активных и пассивных электронных компонентов.

Нашей специализацией является поставка электронной компонентной базы двойного назначения, продукции таких производителей как XILINX, Intel (ex.ALTERA), Vicor, Microchip, Texas Instruments, Analog Devices, Mini-Circuits, Amphenol, Glenair.

Сотрудничество с глобальными дистрибьюторами электронных компонентов, предоставляет возможность заказывать и получать с международных складов практически любой перечень компонентов в оптимальные для Вас сроки.

На всех этапах разработки и производства наши партнеры могут получить квалифицированную поддержку опытных инженеров.

Система менеджмента качества компании отвечает требованиям в соответствии с ГОСТ Р ИСО 9001, ГОСТ РВ 0015-002 и ЭС РД 009

Офис по работе с юридическими лицами:

105318, г.Москва, ул.Щербаковская д.3, офис 1107, 1118, ДЦ «Щербаковский»

Телефон: +7 495 668-12-70 (многоканальный)

Факс: +7 495 668-12-70 (доб.304)

E-mail: info@moschip.ru

Skype отдела продаж:

moschip.ru

moschip.ru_4

moschip.ru_6

moschip.ru_9