

PS9031

R08DS0131EJ0200

Rev.2.00

2.5 A OUTPUT CURRENT, HIGH CMR, IGBT GATE DRIVE,
5-PIN SOP (LSO5 WITH 8mm CREEPAGE DISTANCE) PHOTOCOUPLER

Mar 11, 2016

DESCRIPTION

The PS9031 is an optically coupled isolator containing a GaAlAs LED on the input side and a photodiode, a signal processing circuit and power MOSFETs on the output side on one chip.

FEATURES

- Long creepage distance (8 mm MIN.)
- Large peak output current (2.5 A MAX., 2.0 A MIN.)
- High speed switching (t_{PLH} , t_{PHL} = 175 ns MAX.)
- UVLO (Under Voltage Lock Out) protection with hysteresis
- High common mode transient immunity (CM_H , CM_L = ± 50 kV/ μ s MIN.)
- Operating Ambient Temperature (125 °C MAX.)
- Embossed tape product : PS9031-F3 : 3000 pcs/reel
- Pb-Free product
- Safety standards
 - UL approved: UL1577, Double protection
 - CSA approved: CA5A, CAN/CSA-C22.2 No.60065, CAN/CSA-C22.2 No.60950-1, Reinforced insulation
 - VDE approved: DIN EN 60747-5-5 (Option)

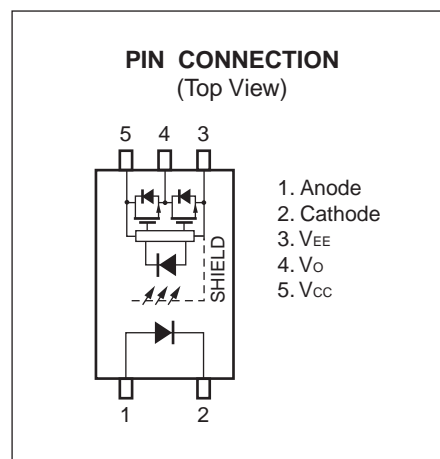

APPLICATIONS

- IGBT, Power MOS FET Gate Driver
- Industrial inverter
- AC Servo

Start of mass production

Oct.2015

PACKAGE DIMENSIONS (UNIT: mm)

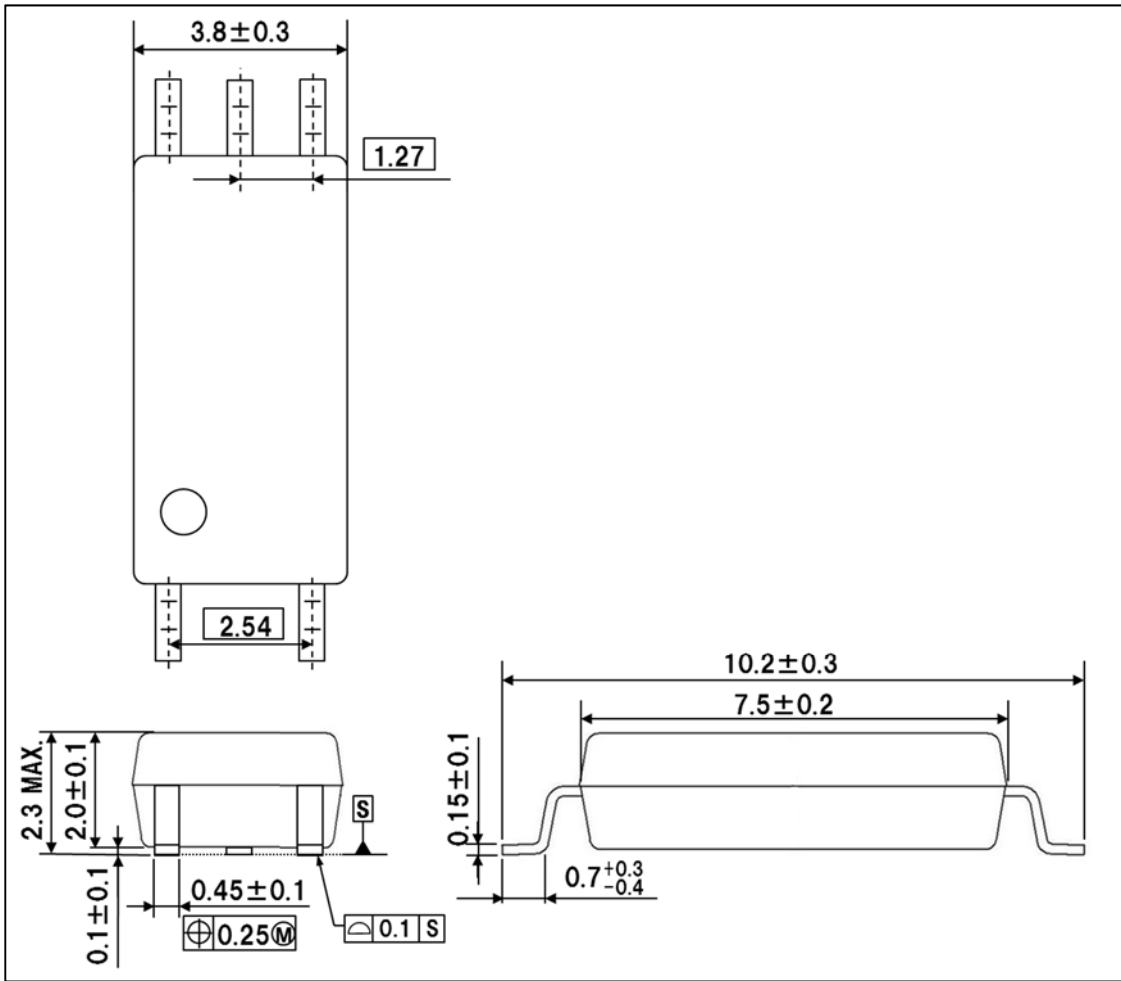

Weight: 0.119g (typ.)

PHOTOCOUPLER CONSTRUCTION

Parameter	MIN.
Air Distance	8.0 mm
Outer Creepage Distance	8.0 mm
Isolation Distance	0.15 mm

BLOCK DIAGRAM

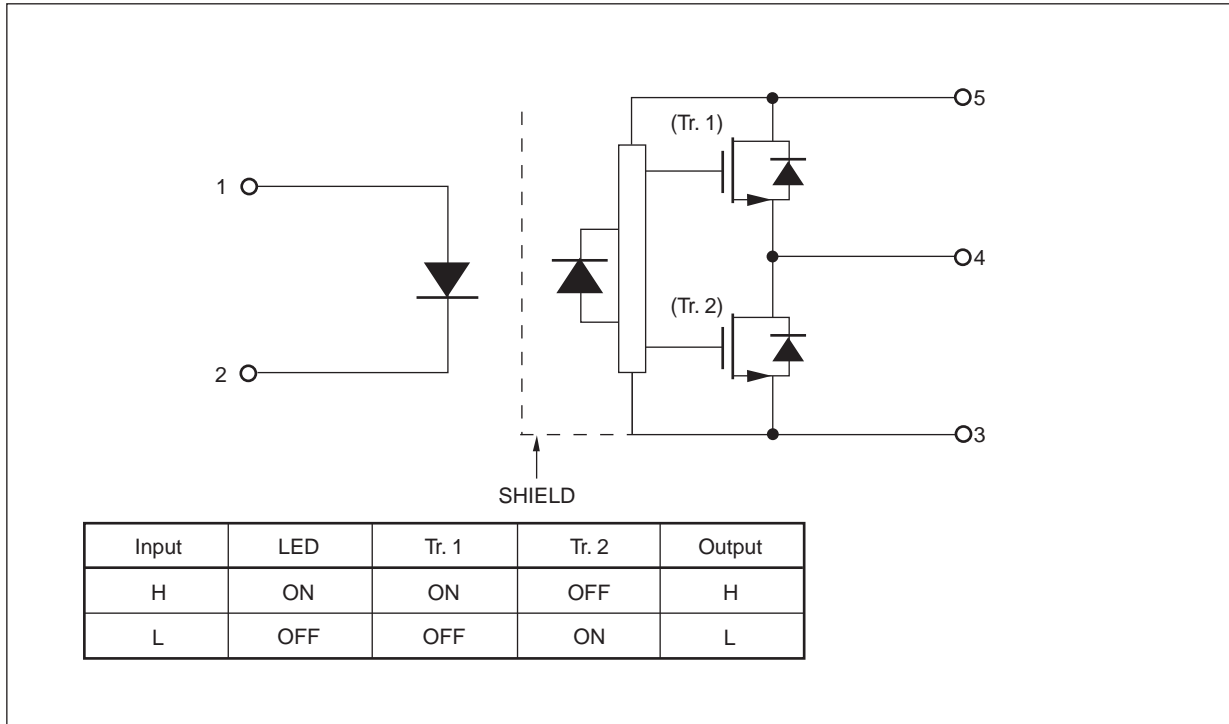

MARKING EXAMPLE

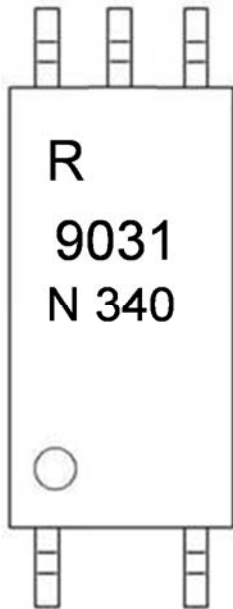

R	An initial of "Renesas"	
9031	Product Part Number	
○	No. 1 pin Mark, Anode Mark	
N340	N	Rank Code
		340
	3	Last one-digit of Assembly Year
		40

ORDERING INFORMATION

Part Number	Order Number	Solder Plating Specification	Packing Style	Safety Standard Approval	Application Part Number ^{*1}
PS9031	PS9031-Y-AX	Pb-Free and Halogen Free (Ni/Pd/Au)	20 pcs (Tape 20 pcs cut)	Standard products (UL, CSA approved)	PS9031
PS9031-F3	PS9031-Y-F3-AX		Embossed Tape 3 000 pcs/reel		
PS9031-V	PS9031-Y-V-AX		20 pcs (Tape 20 pcs cut)	UL, CSA approved DIN EN 60747-5-5 (VDE 0884-5): 2011-11 approved (Option)	
PS9031-V-F3	PS9031-Y-V-F3-AX		Embossed Tape 3 000 pcs/reel		

Note: *1. For the application of the Safety Standard, following part number should be used.

ABSOLUTE MAXIMUM RATINGS ($T_A = 25^\circ\text{C}$, unless otherwise specified)

Parameter		Symbol	Ratings	Unit
Diode	Forward Current	I_F	25	mA
	Peak Transient Forward Current (Pulse Width < 1 μs)	$I_{F(\text{TRAN})}$	1.0	A
	Reverse Voltage	V_R	5	V
	Power Dissipation ^{*1}	P_D	45	mW
Detector	High Level Peak Output Current ^{*2}	$I_{OH(\text{PEAK})}$	2.5	A
	Low Level Peak Output Current ^{*2}	$I_{OL(\text{PEAK})}$	2.5	A
	Supply Voltage	$(V_{CC} - V_{EE})$	0 to 35	V
	Output Voltage	V_O	0 to V_{CC}	V
	Power Dissipation ^{*3}	P_C	250	mW
Isolation Voltage ^{*4}		BV	5 000	Vr.m.s.
Operating Frequency		f	200	kHz
Operating Ambient Temperature		T_A	-40 to +125	$^\circ\text{C}$
Storage Temperature		T_{stg}	-55 to +150	$^\circ\text{C}$

Notes: *1. Reduced to 1.2 mW/ $^\circ\text{C}$ at $T_A = 110^\circ\text{C}$ or more.

*2. Maximum pulse width = 10 μs , Maximum duty cycle = 0.2%

*3. Reduced to 3.9 mW/ $^\circ\text{C}$ at $T_A = 90^\circ\text{C}$ or more.

*4. AC voltage for 1 minute at $T_A = 25^\circ\text{C}$, RH = 60% between input and output.

Pins 1-2 shorted together, 3-5 shorted together.

RECOMMENDED OPERATING CONDITIONS

Parameter	Symbol	MIN.	TYP.	MAX.	Unit
Supply Voltage	$(V_{CC} - V_{EE})$	15		30	V
Forward Current (ON)	$I_{F(\text{ON})}$	8	10	12	mA
Forward Voltage (OFF)	$V_{F(\text{OFF})}$	-2		0.8	V
Operating Ambient Temperature	T_A	-40		125	$^\circ\text{C}$

ELECTRICAL CHARACTERISTICS(at RECOMMENDED OPERATING CONDITIONS, $V_{EE}=GND$, unless otherwise Specified)

Parameter		Symbol	Conditions	MIN.	TYP.*1	MAX.	Unit
Diode	Forward Voltage	V_F	$I_F = 10 \text{ mA}$, $T_A = 25^\circ\text{C}$	1.35	1.56	1.75	V
	Reverse Current	I_R	$V_R = 3 \text{ V}$, $T_A = 25^\circ\text{C}$			10	μA
	Input Capacitance	C_{IN}	$f = 1 \text{ MHz}$, $V_F = 0 \text{ V}$		30		pF
Detector	High Level Output Current	I_{OH}	$V_O = (V_{CC} - 4 \text{ V})^{*2}$	0.5	2.2		A
			$V_O = (V_{CC} - 15 \text{ V})^{*3}$	2.0			
	Low Level Output Current	I_{OL}	$V_O = (V_{EE} + 2.5 \text{ V})^{*2}$	0.5	2.4		A
			$V_O = (V_{EE} + 15 \text{ V})^{*3}$	2.0			
	High Level Output Voltage	V_{OH}	$I_O = -100 \text{ mA}^{*4}$	$V_{CC} - 3.0$	$V_{CC} - 1.3$		V
	Low Level Output Voltage	V_{OL}	$I_O = 100 \text{ mA}$		0.2	0.5	V
	High Level Supply Current	I_{CCH}	$V_O = \text{Open}$, $I_F = 10 \text{ mA}$		1.7	2.2	mA
	Low Level Supply Current	I_{CCL}	$V_O = \text{Open}$, $V_F = 0 \text{ to } 0.8\text{V}$		1.7	2.2	mA
	UVLO Threshold	V_{UVLO+}	$V_O > 5 \text{ V}$, $I_F = 10 \text{ mA}$	10.8	12.3	13.4	V
V_{UVLO-}		9.5		11.0	12.5		
UVLO Hysteresis	$UVLO_{HYS}$	$V_O > 5 \text{ V}$, $I_F = 10 \text{ mA}$	0.4	1.3		V	
Coupled	Threshold Input Current (L \rightarrow H)	I_{FLH}	$I_O = 0 \text{ mA}$, $V_O > 5 \text{ V}$		1.7	4.0	mA
	Threshold Input Voltage (H \rightarrow L)	V_{FHL}	$I_O = 0 \text{ mA}$, $V_O < 5 \text{ V}$	0.8			V

Notes: *1. Typical values at $T_A = 25^\circ\text{C}$, $V_{CC} - V_{EE} = 30 \text{ V}$.*2. Maximum pulse width = 50 μs , Maximum duty cycle = 0.5%.*3. Maximum pulse width = 10 μs , Maximum duty cycle = 0.2%.*4. V_{OH} is measured with the DC load current in this testing (Maximum pulse width = 2 ms, Maximum duty cycle = 20%).**SWITCHING CHARACTERISTICS**(at RECOMMENDED OPERATING CONDITIONS, $V_{EE}=GND$, unless otherwise specified)

Parameter	Symbol	Conditions	MIN.	TYP.*1	MAX.	Unit	
Propagation Delay Time (L \rightarrow H)	t_{PLH}	$R_g = 10 \Omega$, $C_g = 10 \text{ nF}$, $f = 10 \text{ kHz}$, Duty Cycle = 50%, $I_F = 10 \text{ mA}$		80	175	ns	
Propagation Delay Time (H \rightarrow L)	t_{PHL}			105	175	ns	
Pulse Width Distortion (PWD)	$ t_{PHL} - t_{PLH} $				25	75	ns
Propagation Delay Time (Difference Between Any Two Products)	$t_{PHL} - t_{PLH}$			-90		90	ns
Rise Time	t_r				40		ns
Fall Time	t_f				40		ns
Common Mode Transient Immunity at High Level Output	$ CM_H $		$T_A = 25^\circ\text{C}$, $I_F = 10 \text{ mA}$, $V_{CC} = 30 \text{ V}$, $V_{CM} = 1.5 \text{ kV}$	50			$\text{kV}/\mu\text{s}$
Common Mode Transient Immunity at Low Level Output	$ CM_L $	$T_A = 25^\circ\text{C}$, $I_F = 0 \text{ mA}$, $V_{CC} = 30 \text{ V}$, $V_{CM} = 1.5 \text{ kV}$	50			$\text{kV}/\mu\text{s}$	

Notes: *1. Typical values at $T_A = 25^\circ\text{C}$, $V_{CC} - V_{EE} = 30 \text{ V}$.

TEST CIRCUIT

Fig. 1 I_{OH} Test Circuit

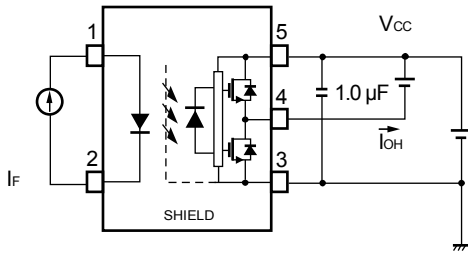

Fig. 2 I_{OL} Test Circuit

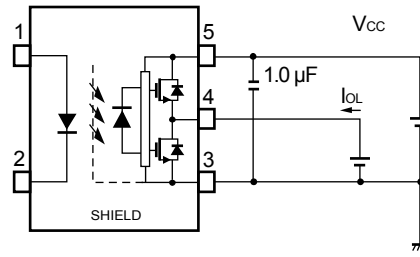

Fig. 3 V_{OH} Test Circuit

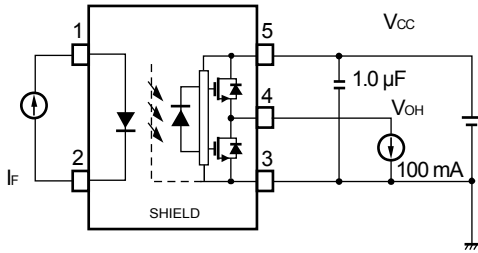

Fig. 4 V_{OL} Test Circuit

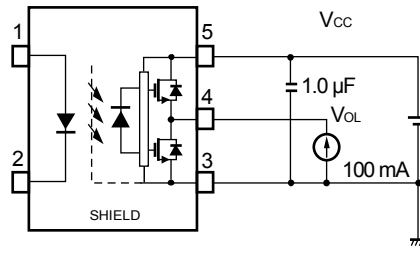

Fig. 5 I_{CCH}/I_{CCL} Test Circuit

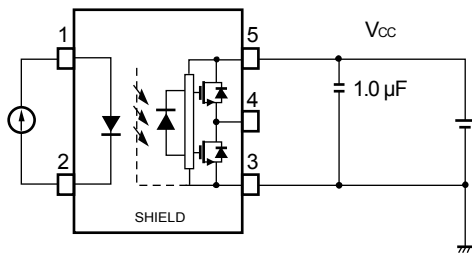

Fig. 6 UVLO Test Circuit

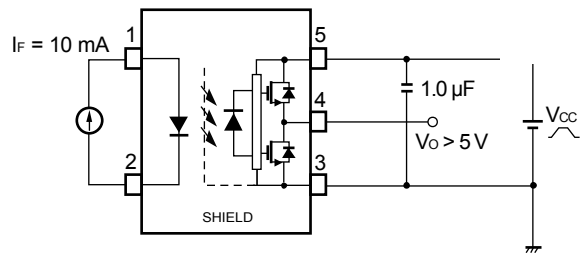

Fig. 7 IFLH Test Circuit

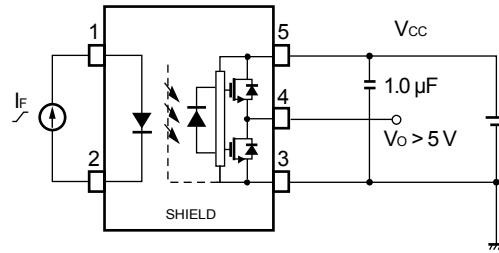

Fig. 8 t_{PLH}, t_{PHL}, t_r, t_f Test Circuit and Wave Forms

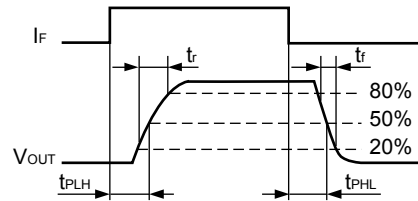
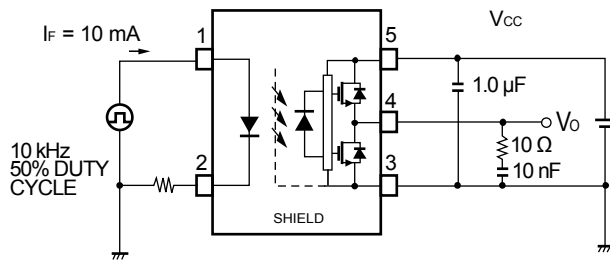
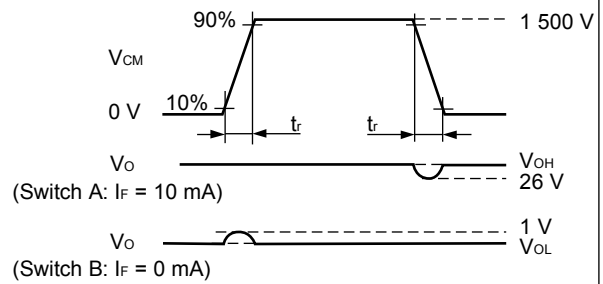
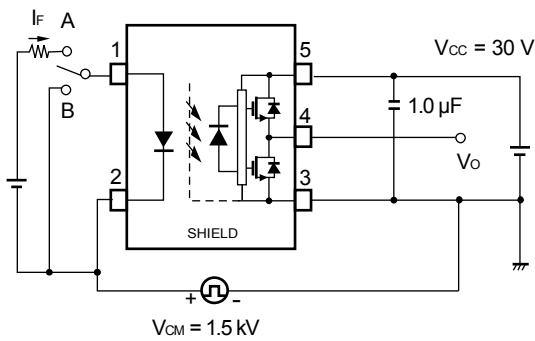
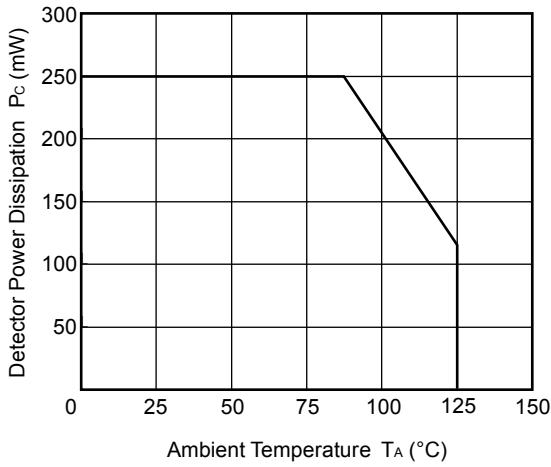

Fig. 9 CMR Test Circuit and Wave Forms



TYPICAL CHARACTERISTICS (T_A = 25°C, unless otherwise specified)

DETECTOR POWER DISSIPATION vs. AMBIENT TEMPERATURE



DIODE POWER DISSIPATION vs. AMBIENT TEMPERATURE

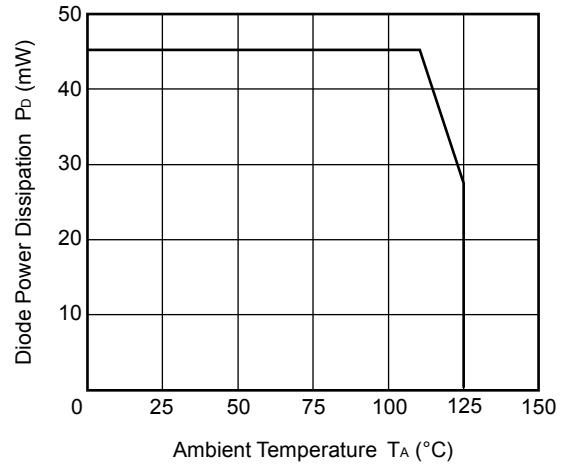

FORWARD CURRENT vs. FORWARD VOLTAGE

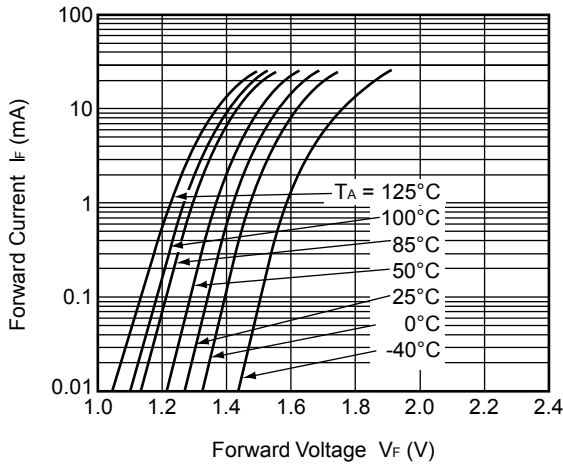

THRESHOLD INPUT CURRENT vs. AMBIENT TEMPERATURE

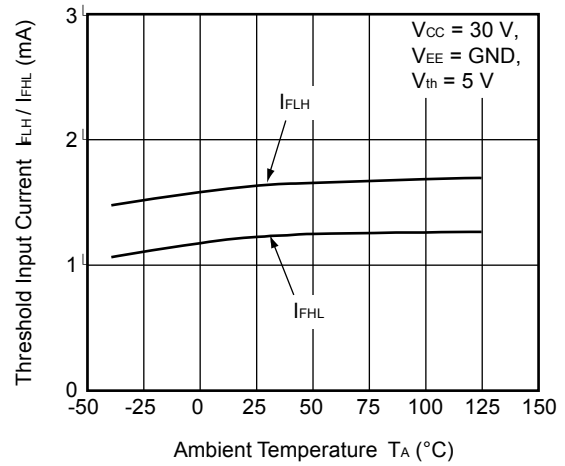

OUTPUT VOLTAGE vs. FORWARD CURRENT

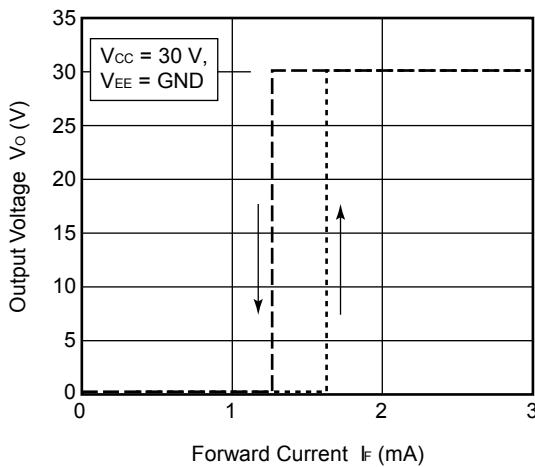

HIGH LEVEL OUTPUT VOLTAGE SUPPLY VOLTAGE vs. HIGH LEVEL OUTPUT CURRENT

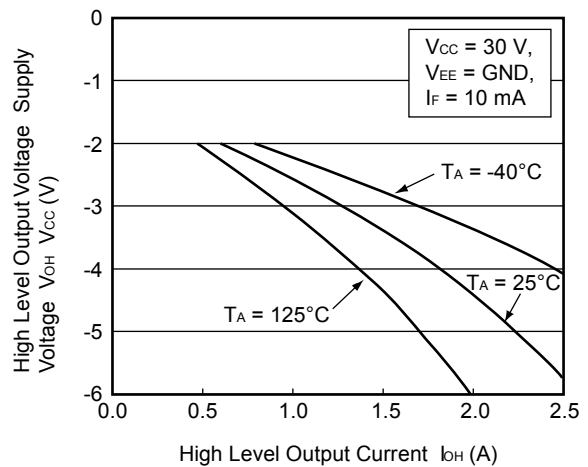

Remark The graphs indicate nominal characteristics.

LOW LEVEL OUTPUT VOLTAGE vs. LOW LEVEL OUTPUT CURRENT

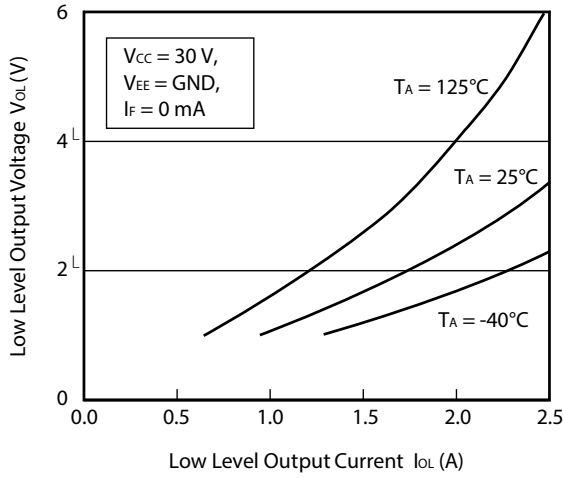

PROPAGATION DELAY TIME, PULSE WIDTH DISTORTION vs. FORWARD CURRENT

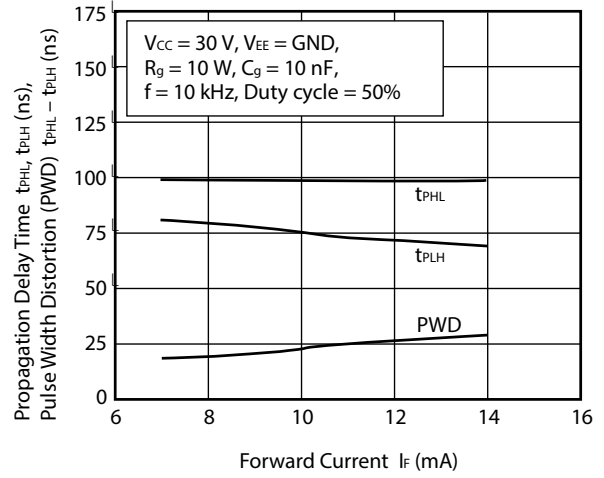

PROPAGATION DELAY TIME, PULSE WIDTH DISTORTION vs. SUPPLY VOLTAGE

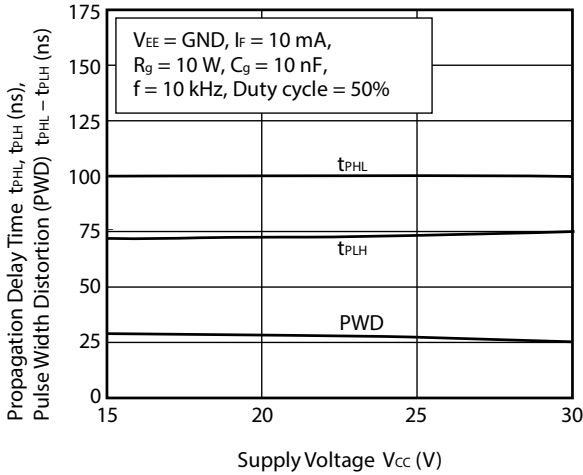

PROPAGATION DELAY TIME, PULSE WIDTH DISTORTION vs. LOAD CAPACITANCE

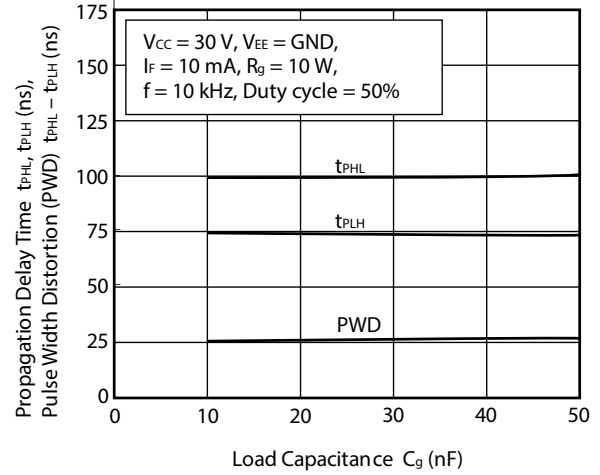

PROPAGATION DELAY TIME, PULSE WIDTH DISTORTION vs. LOAD RESISTANCE

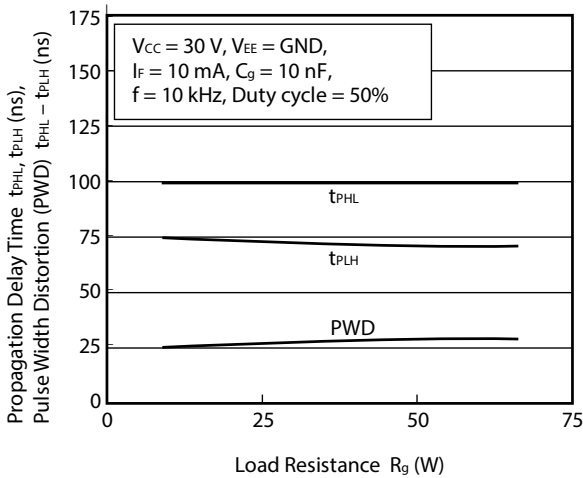

PROPAGATION DELAY TIME, PULSE WIDTH DISTORTION vs. AMBIENT TEMPERATURE

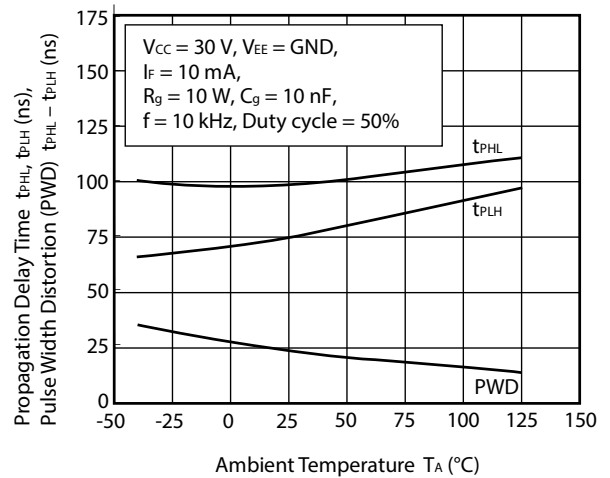

Remark The graphs indicate nominal characteristics.

SUPPLY CURRENT vs. AMBIENT TEMPERATURE

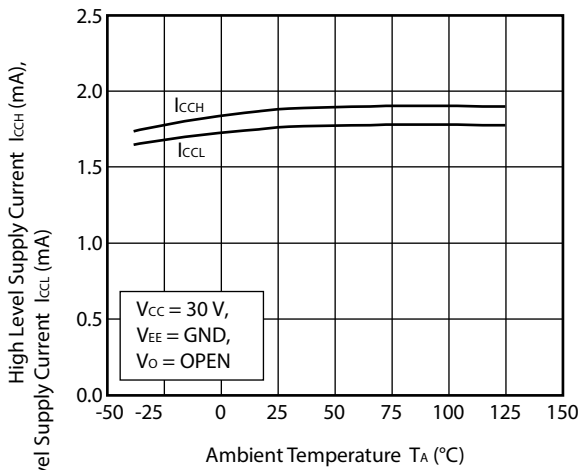

SUPPLY CURRENT vs. SUPPLY VOLTAGE

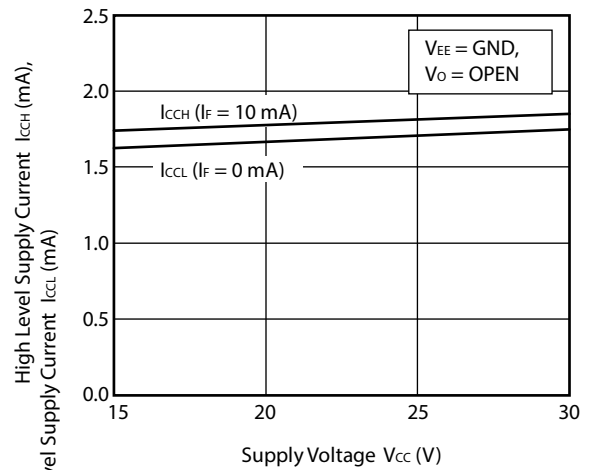

HIGH LEVEL OUTPUT VOLTAGE – SUPPLY VOLTAGE vs. AMBIENT TEMPERATURE

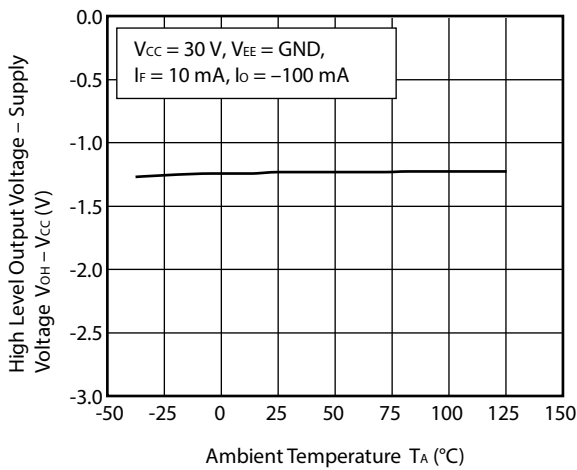

LOW LEVEL OUTPUT VOLTAGE vs. AMBIENT TEMPERATURE

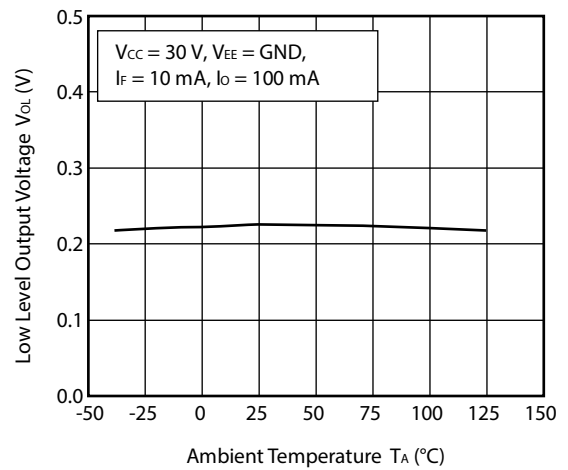

HIGH LEVEL OUTPUT CURRENT vs. AMBIENT TEMPERATURE

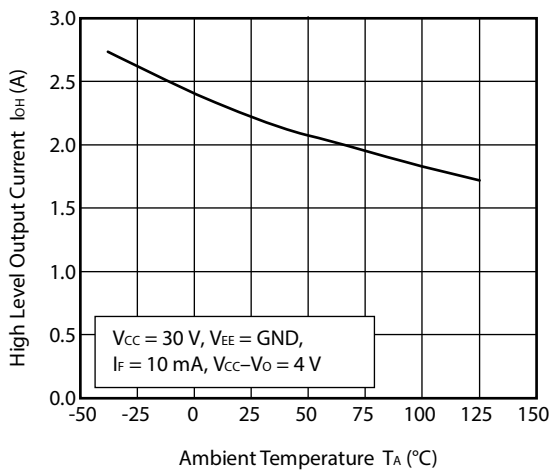

LOW LEVEL OUTPUT CURRENT vs. AMBIENT TEMPERATURE

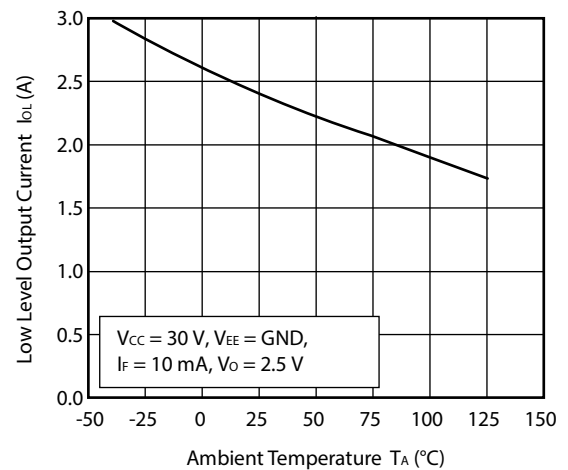

Remark The graphs indicate nominal characteristics.

OUTPUT VOLTAGE vs. SUPPLY VOLTAGE

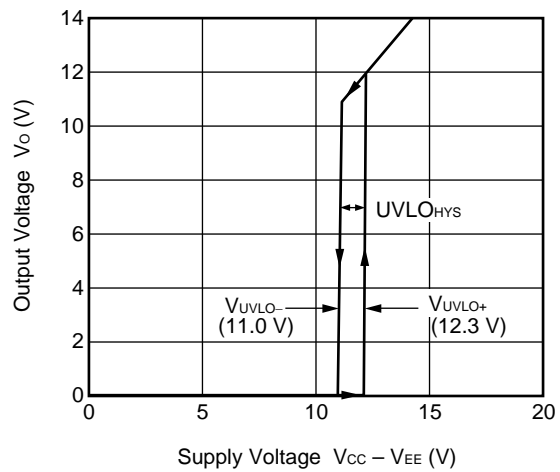

Remark The graphs indicate nominal characteristics.

TAPING SPECIFICATIONS (UNIT: mm)

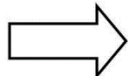
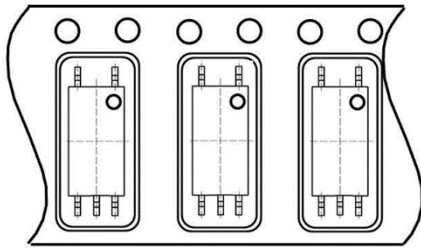

Tape Direction

Outline and Dimensions (Taps)

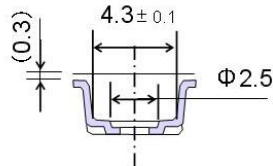
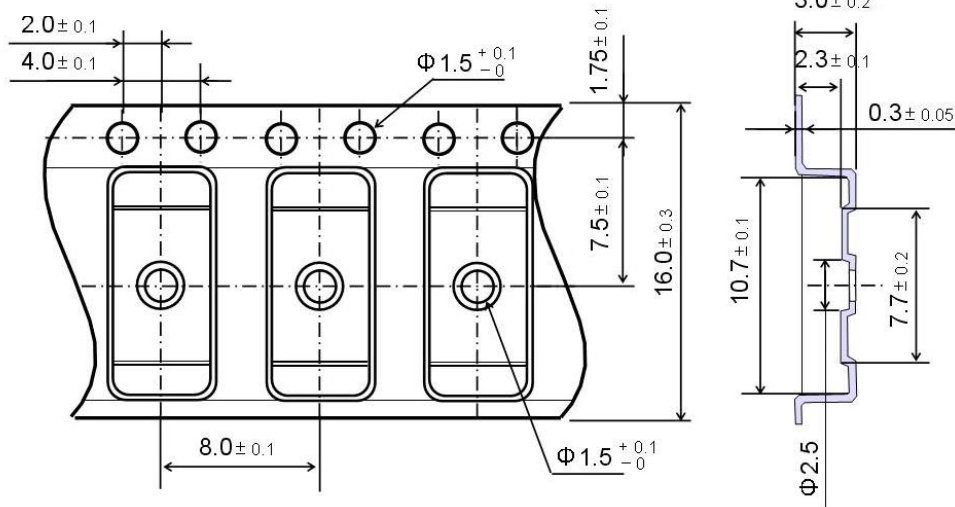

Outline and Dimensions (Reel)

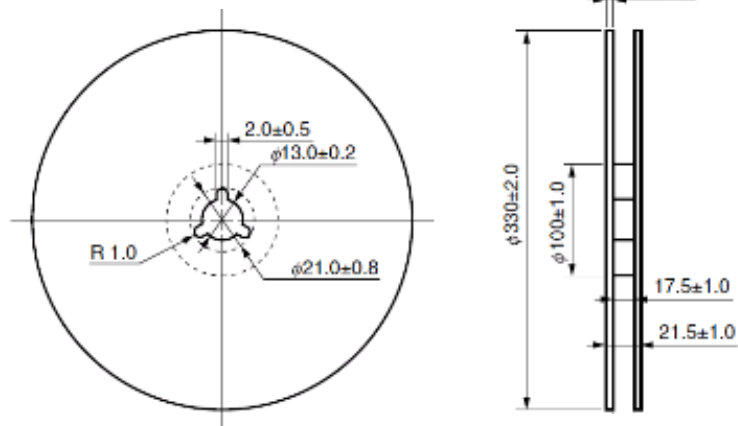

Packing: 3000 pcs/reel

RECOMMENDED MOUNT PAD DIMENSIONS (UNIT: mm)

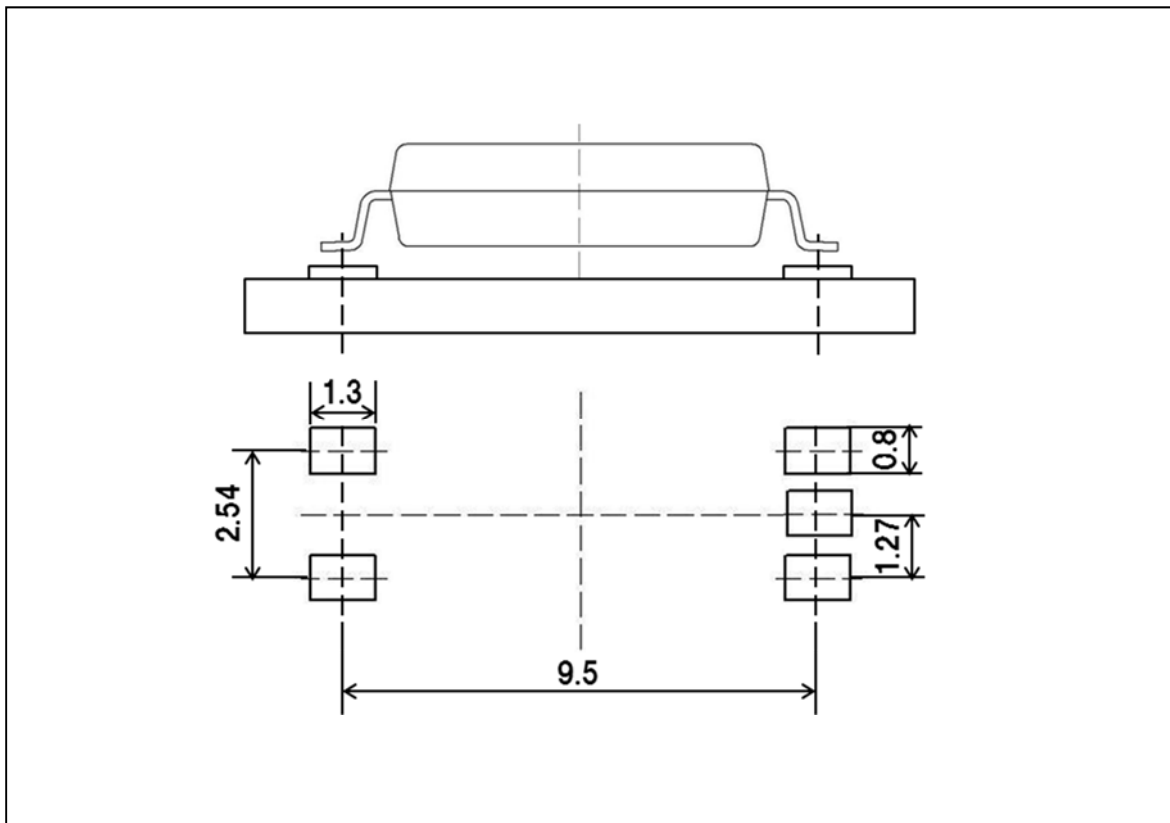

Remark All dimensions in this figure must be evaluated before use.

NOTES ON HANDLING

1. Recommended soldering conditions

(1) Infrared reflow soldering

- Peak reflow temperature 260°C or below (package surface temperature)
- Time of peak reflow temperature 10 seconds or less
- Time of temperature higher than 220°C 60 seconds or less
- Time to preheat temperature from 120 to 180°C 120±30 s
- Number of reflows Three
- Flux Rosin flux containing small amount of chlorine (The flux with a maximum chlorine content of 0.2 Wt% is recommended.)

Recommended Temperature Profile of Infrared Reflow

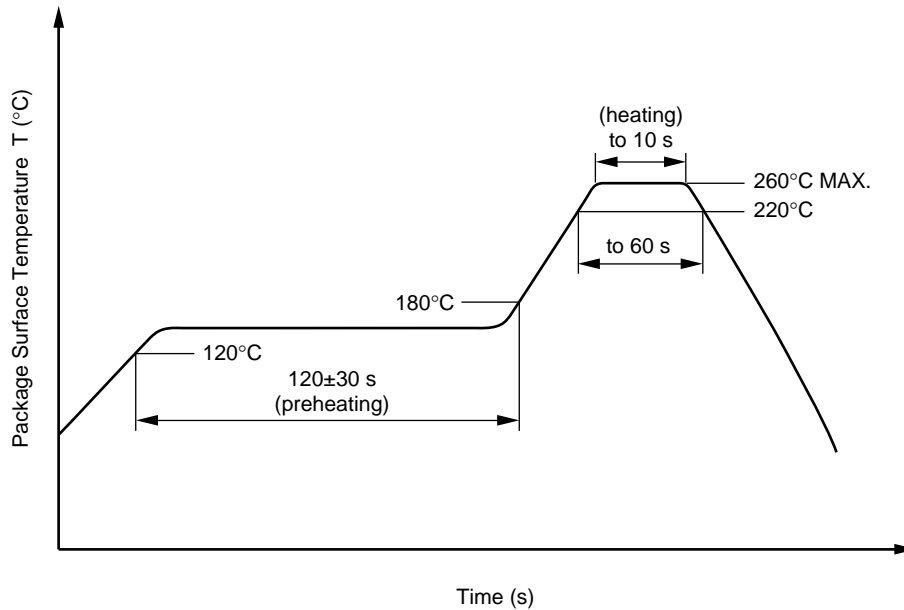

(2) Wave soldering

- Temperature 260°C or below (molten solder temperature)
- Time 10 seconds or less
- Preheating conditions 120°C or below (package surface temperature)
- Number of times One (Allowed to be dipped in solder including plastic mold portion.)
- Flux Rosin flux containing small amount of chlorine (The flux with a maximum chlorine content of 0.2 Wt% is recommended.)

(3) Soldering by Soldering Iron

- Peak Temperature (lead part temperature) 350°C or below
- Time (each pins) 3 seconds or less
- Flux Rosin flux containing small amount of chlorine (The flux with a maximum chlorine content of 0.2 Wt% is recommended.)

(a) Soldering of leads should be made at the point 1.5 to 2.0 mm from the root of the lead

(4) Cautions

- Fluxes Avoid removing the residual flux with freon-based and chlorine-based cleaning solvent.

2. Cautions regarding noise

Be aware that when voltage is applied suddenly between the photocoupler's input and output at startup, the output transistor may enter the on state, even if the voltage is within the absolute maximum ratings.

USAGE CAUTIONS

1. This product is weak for static electricity by designed with high-speed integrated circuit so protect against static electricity when handling.
2. Board designing
 - (1) By-pass capacitor of more than 1.0 μF is used between VCC and GND near device. Also, ensure that the distance between the leads of the photocoupler and capacitor is no more than 10 mm.
 - (2) When designing the printed wiring board, ensure that the pattern of the IGBT collectors/emitters is not too close to the input block pattern of the photocoupler.

If the pattern is too close to the input block and coupling occurs, a sudden fluctuation in the voltage on the IGBT output side might affect the photocoupler's LED input, leading to malfunction or degradation of characteristics.

(If the pattern needs to be close to the input block, to prevent the LED from lighting during the off state due to the abovementioned coupling, design the input-side circuit so that the bias of the LED is reversed, within the range of the recommended operating conditions, and be sure to thoroughly evaluate operation.)
3. Make sure the rise/fall time of the forward current is 0.5 μs or less.
4. In order to avoid malfunctions, make sure the rise/fall slope of the supply voltage is 3 V/ μs or less.
5. Avoid storage at a high temperature and high humidity.

SPECIFICATION OF VDE MARKS LICENSE DOCUMENT

Parameter	Symbol	Spec.	Unit
Climatic test class (IEC 60068-1/DIN EN 60068-1)		40/125/21	
Dielectric strength maximum operating isolation voltage Test voltage (partial discharge test, procedure a for type test and random test) $U_{pr} = 1.6 \times U_{IORM}, P_d < 5 \text{ pC}$	U_{IORM} U_{pr}	1 130 1 808	V_{peak} V_{peak}
Test voltage (partial discharge test, procedure b for all devices) $U_{pr} = 1.875 \times U_{IORM}, P_d < 5 \text{ pC}$	U_{pr}	2 119	V_{peak}
Highest permissible overvoltage	U_{IOTM}	8 000	V_{peak}
Degree of pollution (DIN EN 60664-1 VDE0110 Part 1)		2	
Comparative tracking index (IEC 60112/DIN EN 60112 (VDE 0303 Part 11))	CTI	400	
Material group (DIN EN 60664-1 VDE0110 Part 1)		II	
Storage temperature range	T_{stg}	-55 to +150	°C
Operating temperature range	T_A	-40 to +125	°C
Isolation resistance, minimum value $V_{IO} = 500 \text{ V dc at } T_A = 25^\circ\text{C}$ $V_{IO} = 500 \text{ V dc at } T_A \text{ MAX. at least } 100^\circ\text{C}$	Ris MIN. Ris MIN.	10^{12} 10^{11}	Ω Ω
Safety maximum ratings (maximum permissible in case of fault, see thermal derating curve) Package temperature Current (input current I_F , $P_{si} = 0$) Power (output or total power dissipation) Isolation resistance $V_{IO} = 500 \text{ V dc at } T_A = T_{si}$	T_{si} I_{si} P_{si} Ris MIN.	175 400 700 10^9	°C mA mW Ω

Dependence of maximum safety ratings with package temperature

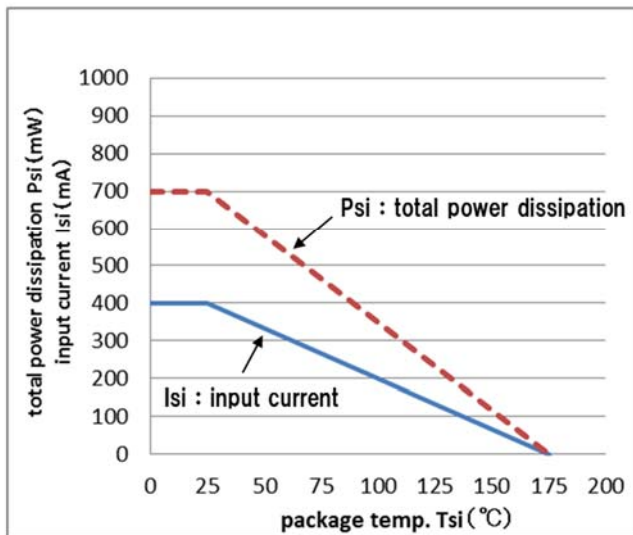

Method A Destructive Test, Type and Sample test

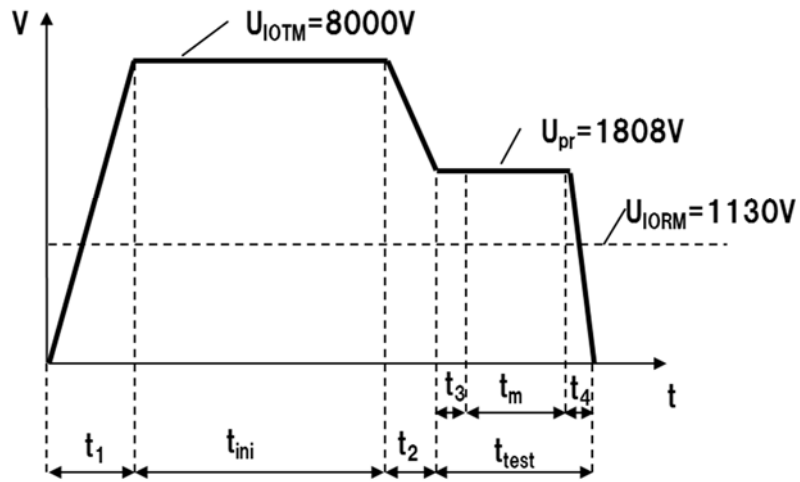

$t_1, t_2 = 1 \text{ to } 10 \text{ sec}$
 $t_3, t_4 = 1 \text{ sec}$
 $t_m \text{ (PARTIAL DISCHARGE)} = 10 \text{ sec}$
 $t_{\text{test}} = 12 \text{ sec}$
 $t_{\text{ini}} = 60 \text{ sec}$

Method b Non-destructive Test, 100% Production Test

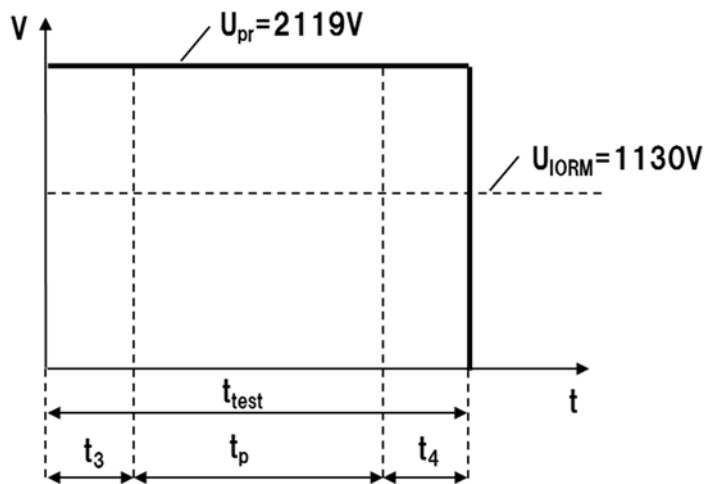

$t_3, t_4 = 0.1 \text{ sec}$
 $t_p \text{ (PARTIAL DISCHARGE)} = 1.0 \text{ sec}$
 $t_{\text{test}} = 1.2 \text{ sec}$

Caution	GaAs Products	<p>This product uses gallium arsenide (GaAs). GaAs vapor and powder are hazardous to human health if inhaled or ingested, so please observe the following points.</p> <ul style="list-style-type: none">• Follow related laws and ordinances when disposing of the product. If there are no applicable laws and/or ordinances, dispose of the product as recommended below.<ol style="list-style-type: none">1. Commission a disposal company able to (with a license to) collect, transport and dispose of materials that contain arsenic and other such industrial waste materials.2. Exclude the product from general industrial waste and household garbage, and ensure that the product is controlled (as industrial waste subject to special control) up until final disposal.• Do not burn, destroy, cut, crush, or chemically dissolve the product.• Do not lick the product or in any way allow it to enter the mouth.
----------------	---------------	--

Notice

1. Descriptions of circuits, software and other related information in this document are provided only to illustrate the operation of semiconductor products and application examples. You are fully responsible for the incorporation of these circuits, software, and information in the design of your equipment. Renesas Electronics assumes no responsibility for any losses incurred by you or third parties arising from the use of these circuits, software, or information.
2. Renesas Electronics has used reasonable care in preparing the information included in this document, but Renesas Electronics does not warrant that such information is error free. Renesas Electronics assumes no liability whatsoever for any damages incurred by you resulting from errors in or omissions from the information included herein.
3. Renesas Electronics does not assume any liability for infringement of patents, copyrights, or other intellectual property rights of third parties by or arising from the use of Renesas Electronics products or technical information described in this document. No license, express, implied or otherwise, is granted hereby under any patents, copyrights or other intellectual property rights of Renesas Electronics or others.
4. You should not alter, modify, copy, or otherwise misappropriate any Renesas Electronics product, whether in whole or in part. Renesas Electronics assumes no responsibility for any losses incurred by you or third parties arising from such alteration, modification, copy or otherwise misappropriation of Renesas Electronics product.
5. Renesas Electronics products are classified according to the following two quality grades: "Standard" and "High Quality". The recommended applications for each Renesas Electronics product depends on the product's quality grade, as indicated below.
"Standard": Computers; office equipment; communications equipment; test and measurement equipment; audio and visual equipment; home electronic appliances; machine tools; personal electronic equipment; and industrial robots etc.
"High Quality": Transportation equipment (automobiles, trains, ships, etc.); traffic control systems; anti-disaster systems; anti-crime systems; and safety equipment etc.
Renesas Electronics products are neither intended nor authorized for use in products or systems that may pose a direct threat to human life or bodily injury (artificial life support devices or systems, surgical implantations etc.), or may cause serious property damages (nuclear reactor control systems, military equipment etc.). You must check the quality grade of each Renesas Electronics product before using it in a particular application. You may not use any Renesas Electronics product for any application for which it is not intended. Renesas Electronics shall not be in any way liable for any damages or losses incurred by you or third parties arising from the use of any Renesas Electronics product for which the product is not intended by Renesas Electronics.
6. You should use the Renesas Electronics products described in this document within the range specified by Renesas Electronics, especially with respect to the maximum rating, operating supply voltage range, movement power voltage range, heat radiation characteristics, installation and other product characteristics. Renesas Electronics shall have no liability for malfunctions or damages arising out of the use of Renesas Electronics products beyond such specified ranges.
7. Although Renesas Electronics endeavors to improve the quality and reliability of its products, semiconductor products have specific characteristics such as the occurrence of failure at a certain rate and malfunctions under certain use conditions. Further, Renesas Electronics products are not subject to radiation resistance design. Please be sure to implement safety measures to guard them against the possibility of physical injury, and injury or damage caused by fire in the event of the failure of a Renesas Electronics product, such as safety design for hardware and software including but not limited to redundancy, fire control and malfunction prevention, appropriate treatment for aging degradation or any other appropriate measures. Because the evaluation of microcomputer software alone is very difficult, please evaluate the safety of the final products or systems manufactured by you.
8. Please contact a Renesas Electronics sales office for details as to environmental matters such as the environmental compatibility of each Renesas Electronics product. Please use Renesas Electronics products in compliance with all applicable laws and regulations that regulate the inclusion or use of controlled substances, including without limitation, the EU RoHS Directive. Renesas Electronics assumes no liability for damages or losses occurring as a result of your noncompliance with applicable laws and regulations.
9. Renesas Electronics products and technology may not be used for or incorporated into any products or systems whose manufacture, use, or sale is prohibited under any applicable domestic or foreign laws or regulations. You should not use Renesas Electronics products or technology described in this document for any purpose relating to military applications or use by the military, including but not limited to the development of weapons of mass destruction. When exporting the Renesas Electronics products or technology described in this document, you should comply with the applicable export control laws and regulations and follow the procedures required by such laws and regulations.
10. It is the responsibility of the buyer or distributor of Renesas Electronics products, who distributes, disposes of, or otherwise places the product with a third party, to notify such third party in advance of the contents and conditions set forth in this document, Renesas Electronics assumes no responsibility for any losses incurred by you or third parties as a result of unauthorized use of Renesas Electronics products.
11. This document may not be reproduced or duplicated in any form, in whole or in part, without prior written consent of Renesas Electronics.
12. Please contact a Renesas Electronics sales office if you have any questions regarding the information contained in this document or Renesas Electronics products, or if you have any other inquiries.

(Note 1) "Renesas Electronics" as used in this document means Renesas Electronics Corporation and also includes its majority-owned subsidiaries.

(Note 2) "Renesas Electronics product(s)" means any product developed or manufactured by or for Renesas Electronics.



SALES OFFICES

Renesas Electronics Corporation

<http://www.renesas.com>

Refer to "<http://www.renesas.com/>" for the latest and detailed information.

California Eastern Laboratories, Inc.

4590 Patrick Henry Drive, Santa Clara, California 95054-1817, U.S.A.
Tel: +1-408-919-2500, Fax: +1-408-988-0279

Renesas Electronics Europe Limited

Dukes Meadow, Millboard Road, Bourne End, Buckinghamshire, SL8 5FH, U.K.
Tel: +44-1628-585-100, Fax: +44-1628-585-900

Renesas Electronics Europe GmbH

Arcadiastrasse 10, 40472 Düsseldorf, Germany
Tel: +49-211-6503-0, Fax: +49-211-6503-1327

Renesas Electronics (China) Co., Ltd.

Room 1709, Quantum Plaza, No.27 ZhiChunLu Haidian District, Beijing 100191, P.R.China
Tel: +86-10-8235-1155, Fax: +86-10-8235-7679

Renesas Electronics (Shanghai) Co., Ltd.

Unit 301, Tower A, Central Towers, 555 Langao Road, Putuo District, Shanghai, P. R. China 200333
Tel: +86-21-2226-0888, Fax: +86-21-2226-0999

Renesas Electronics Hong Kong Limited

Unit 1601-1611, 16/F., Tower 2, Grand Century Place, 193 Prince Edward Road West, Mongkok, Kowloon, Hong Kong
Tel: +852-2265-6688, Fax: +852 2886-9022

Renesas Electronics Taiwan Co., Ltd.

13F, No. 363, Fu Shing North Road, Taipei 10543, Taiwan
Tel: +886-2-8175-9600, Fax: +886 2-8175-9670

Renesas Electronics Singapore Pte. Ltd.

80 Bendemeer Road, Unit #06-02, Hyflux Innovation Centre, Singapore 339949
Tel: +65-6213-0200, Fax: +65-6213-0300

Renesas Electronics Malaysia Sdn.Bhd.

Unit 1207, Block B, Menara Amcorp, Amcorp Trade Centre, No. 18, Jln Persiaran Barat, 46050 Petaling Jaya, Selangor Darul Ehsan, Malaysia
Tel: +60-3-7955-9390, Fax: +60-3-7955-9510

Renesas Electronics India Pvt. Ltd.

No.777C, 100 Feet Road, HAL II Stage, Indiranagar, Bangalore, India
Tel: +91-80-67208700, Fax: +91-80-67208777

Renesas Electronics Korea Co., Ltd.

12F., 234 Teheran-ro, Gangnam-Gu, Seoul, 135-080, Korea
Tel: +82-2-558-3737, Fax: +82-2-558-5141

Mouser Electronics

Authorized Distributor

Click to View Pricing, Inventory, Delivery & Lifecycle Information:

[Renesas Electronics:](#)

[PS9031-Y-F3-AX](#) [PS9031-Y-V-F3-AX](#)

Данный компонент на территории Российской Федерации

Вы можете приобрести в компании MosChip.

Для оперативного оформления запроса Вам необходимо перейти по данной ссылке:

<http://moschip.ru/get-element>

Вы можете разместить у нас заказ для любого Вашего проекта, будь то серийное производство или разработка единичного прибора.

В нашем ассортименте представлены ведущие мировые производители активных и пассивных электронных компонентов.

Нашей специализацией является поставка электронной компонентной базы двойного назначения, продукции таких производителей как XILINX, Intel (ex.ALTERA), Vicor, Microchip, Texas Instruments, Analog Devices, Mini-Circuits, Amphenol, Glenair.

Сотрудничество с глобальными дистрибьюторами электронных компонентов, предоставляет возможность заказывать и получать с международных складов практически любой перечень компонентов в оптимальные для Вас сроки.

На всех этапах разработки и производства наши партнеры могут получить квалифицированную поддержку опытных инженеров.

Система менеджмента качества компании отвечает требованиям в соответствии с ГОСТ Р ИСО 9001, ГОСТ РВ 0015-002 и ЭС РД 009

Офис по работе с юридическими лицами:

105318, г.Москва, ул.Щербаковская д.3, офис 1107, 1118, ДЦ «Щербаковский»

Телефон: +7 495 668-12-70 (многоканальный)

Факс: +7 495 668-12-70 (доб.304)

E-mail: info@moschip.ru

Skype отдела продаж:

moschip.ru

moschip.ru_4

moschip.ru_6

moschip.ru_9