

Kxxxzy SIDAC

RoHS



**Description**

The SIDAC is a silicon bilateral voltage triggered switch. Upon application of a voltage exceeding the SIDAC breakover voltage point, the SIDAC switches on through a negative resistance region to a low on-state voltage. Conduction continues until the current is interrupted or drops below the minimum holding current of the device.

SIDACs feature glass-passivated junctions to ensure a rugged and dependable device capable of withstanding harsh environments.

**Features**

- AC Circuit Oriented
- RoHS Compliant
- Triggering Voltage of 79V to 330V

**Applications**

Suitable for high voltage power supplies, natural gas igniters, high-pressure Sodium lamps, and Xenon flash ignition.

**Schematic Symbol**



**Electrical Specifications (T<sub>J</sub> = 25°C, unless otherwise specified)**

| Symbol           | Parameters                        | Test Conditions | Min | Max | Unit |
|------------------|-----------------------------------|-----------------|-----|-----|------|
| V <sub>BO</sub>  | Breakover/Trigger Voltage         | K0900y          | 79  | 97  | V    |
|                  |                                   | K1050y          | 95  | 113 |      |
|                  |                                   | K1100y          | 104 | 118 |      |
|                  |                                   | K1200y          | 110 | 125 |      |
|                  |                                   | K1300y          | 120 | 138 |      |
|                  |                                   | K1400y          | 130 | 146 |      |
|                  |                                   | K1500y          | 140 | 170 |      |
|                  |                                   | K1800y          | 165 | 195 |      |
|                  |                                   | K200zy          | 190 | 215 |      |
|                  |                                   | K220zy          | 205 | 230 |      |
|                  |                                   | K240zy          | 220 | 250 |      |
|                  |                                   | K250zy          | 240 | 280 |      |
| K300zy           | 270                               | 330             |     |     |      |
| V <sub>DRM</sub> | Repetitive Peak Off-state Voltage | K0900y          | 70  |     | V    |
|                  |                                   | K1050y          | 90  |     |      |
|                  |                                   | K1100y          | 90  |     |      |
|                  |                                   | K1200y          | 90  |     |      |
|                  |                                   | K1300y          | 90  |     |      |
|                  |                                   | K1400y          | 90  |     |      |
|                  |                                   | K1500y          | 90  |     |      |
|                  |                                   | K1800y          | 140 |     |      |
|                  |                                   | K200zy          | 180 |     |      |
|                  |                                   | K220zy          | 180 |     |      |
|                  |                                   | K240zy          | 190 |     |      |
|                  |                                   | K250zy          | 200 |     |      |
| K300zy           | 200                               |                 |     |     |      |

Note: xxx = voltage, z = circuit function, y = package

**Electrical Specifications ( $T_J = 25^\circ\text{C}$ , unless otherwise specified)**

| Symbol          | Parameters  | Test Conditions                        | Min  | Max        | Unit               |
|-----------------|---|--|------|------------|--------------------|
| $I_{T(RMS)}$    | On-state RMS Current  | 50/60Hz, $T_J < 125^\circ\text{C}$     |      | 1          | A                  |
| $I_{DRM}$       | Repetitive Peak Off-state Current                                   | $V = V_{DRM}$<br>50/60Hz Sine Wave     |      | 5          | $\mu\text{A}$      |
| $V_{TM}$        | Peak On-state Voltage   | $I_T = 1\text{A}$<br>Kxxx0y<br>Kxxx2y  |      | 1.5<br>3.0 | V                  |
| $I_H$           | Dynamic Holding Current   | $R_L = 100\Omega$<br>50/60Hz Sine Wave |      | 150        | mA                 |
| $R_S$           | Switching Resistance, $R_S = \frac{(V_{BO} - V_S)}{(I_S - I_{BO})}$ | 50/60Hz Sine Wave                      | 100  |            | $\Omega$           |
| $I_{BO}$        | Breakover Current   | 50/60Hz Sine Wave                      |      | 10         | $\mu\text{A}$      |
| $I_{TRM}$       | Peak Repetitive Pulse Current (refer to figure 4)                   | $t_p = 10\mu\text{s}$<br>60Hz<br>5Hz   |      | 80<br>160  | A                  |
| $I_{TSM}$       | Peak Non-repetitive Surge Current (refer to figure 5)               | Single Cycle<br>60Hz<br>50Hz           |      | 20<br>16.7 | A                  |
| di/dt           | Critical Rate of Rise of On-state Current                           |  |      | 150        | A/ $\mu\text{s}$   |
| dv/dt           | Critical Rate of Rise of Off-state Voltage                          |  | 1500 |            | V/ $\mu\text{s}$   |
| $T_S$           | Storage Temperature Range   |  | -40  | 150        | $^\circ\text{C}$   |
| $T_J$           | Junction Temperature Range  |  | -40  | 125        | $^\circ\text{C}$   |
| $R_{\theta JL}$ | Thermal Resistance, Junction to Lead                                | DO-15<br>DO-214 (1)                    |      | 18<br>30   | $^\circ\text{C/W}$ |
| $R_{\theta JC}$ | Thermal Resistance, Junction to Case                                | TO-92                                  |      | 35         | $^\circ\text{C/W}$ |
| $R_{\theta JA}$ | Thermal Resistance, Junction to Ambient                             | DO-15<br>TO-92                         |      | 75<br>95   | $^\circ\text{C/W}$ |

Notes: xxx = voltage, z = circuit function, y = package  
(1) Mounted on 1 cm<sup>2</sup> copper foil surface; two-ounce copper foil

**Additional Information**



**Datasheet**



**Resources**



**Samples**

**Figure 1: V-I Characteristics**



**Figure 2: On-state Current vs. On-state Voltage (Typical)**



**Figure 3: Power Dissipation vs. On-state Current (Typical)**



**Figure 4: Repetitive Peak On-state Current (I\_TRM) vs. Pulse Width at Various Frequencies**



**Figure 5: Peak Non-repetitive Surge Current (I\_TSM) vs. Number of Cycles**



**Figure 6: Normalized V\_BO Change vs. Junction Temperature**



**Figure 7: Normalized DC Holding Current vs. Junction Temperature**

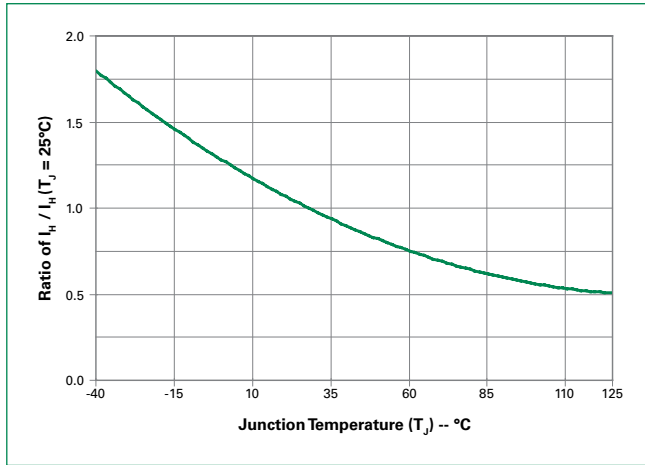

**Figure 8: Maximum Allowable Case Temperature vs. RMS On-State Current**

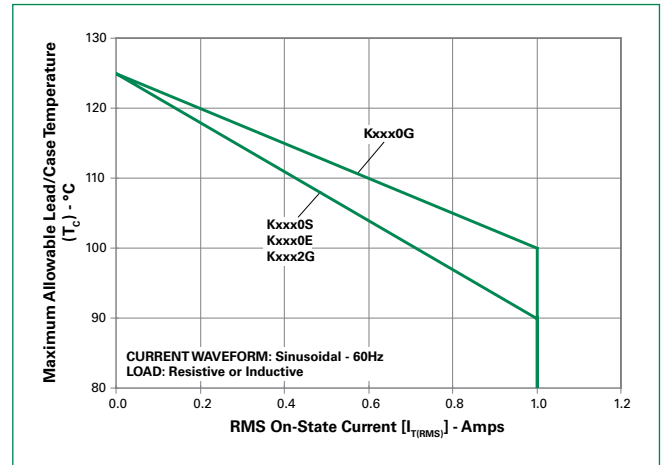

**Figure 9: Maximum Allowable Ambient Temperature vs. RMS On-State Current**

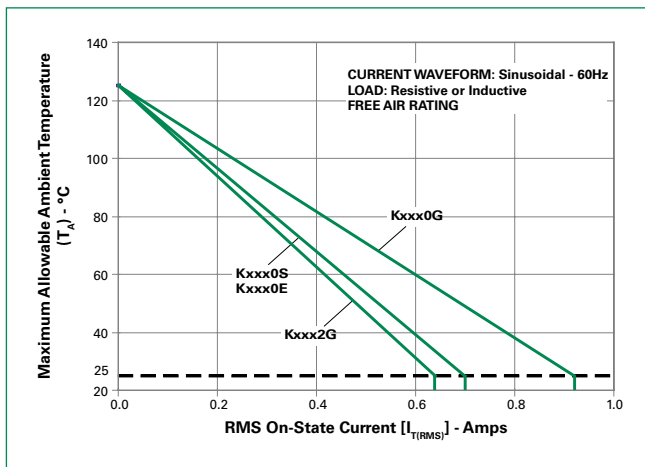

**Figure 10: Normalized Repetitive Peak Breakover Current ( $I_{BO}$ ) vs. Junction Temperature**

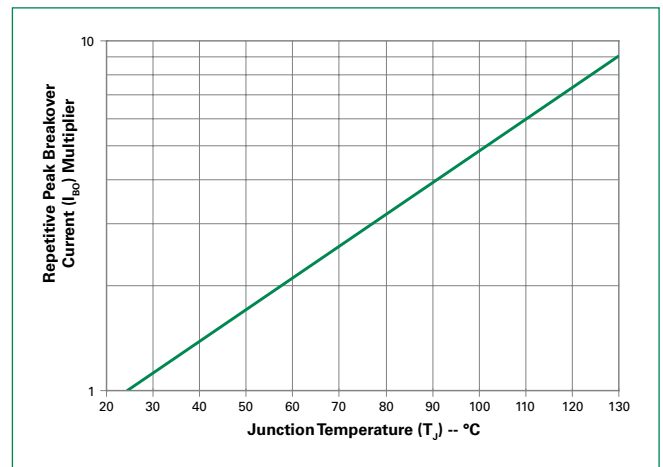

**Figure 11: Dynamic Holding Current Test Circuit for SIDACs**

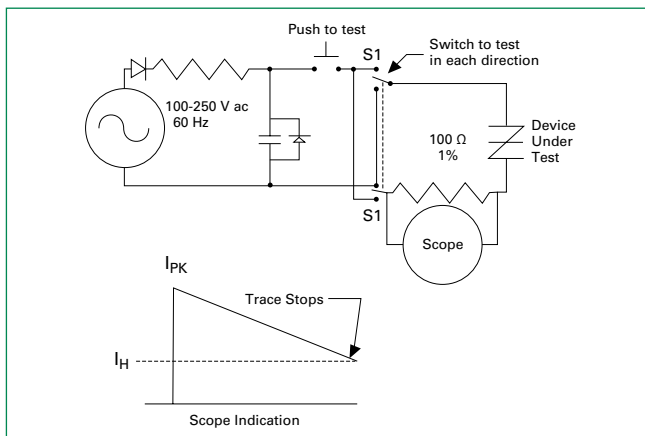

**Figure 12: Basic SIDAC Circuit**

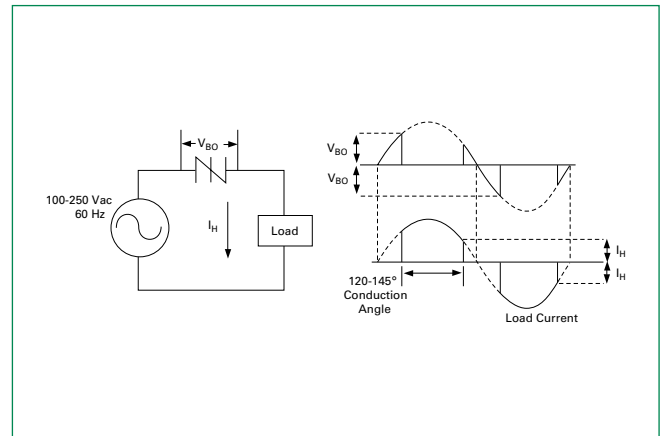

**Figure 13: Relaxation Oscillator Using a SIDAC**



**Figure 14: Low-voltage Input Circuit for Gas Ignition**



**Figure 15: Comparison of SIDAC versus SCR for Gas Ignitor Circuit**



**Figure 16: Xenon Lamp Flashing Circuit**



**Figure 17: Typical High-pressure Sodium Lamp Firing Circuit**

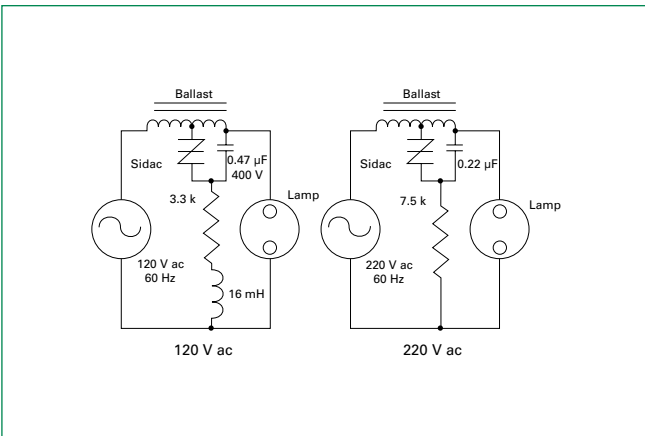

### Soldering Parameters

|  |                                    |                         |
|--|------------------------------------|-------------------------|
| Reflow Condition                                       |                                    | Pb – Free assembly      |
| Pre Heat   | - Temperature Min ( $T_{s(min)}$ ) | 150°C                   |
|  | - Temperature Max ( $T_{s(max)}$ ) | 200°C                   |
|  | - Time (min to max) ( $t_s$ )      | 60 – 180 secs           |
| Average ramp up rate (Liquidus Temp) ( $T_L$ ) to peak |                                    | 5°C/second max          |
| $T_{s(max)}$ to $T_L$ - Ramp-up Rate                   |                                    | 5°C/second max          |
| Reflow   | - Temperature ( $T_L$ ) (Liquidus) | 217°C                   |
|  | - Temperature ( $t_L$ )            | 60 – 150 seconds        |
| Peak Temperature ( $T_p$ )                             |                                    | 260 <sup>+0/-5</sup> °C |
| Time within 5°C of actual peak Temperature ( $t_p$ )   |                                    | 20 – 40 seconds         |
| Ramp-down Rate   |                                    | 5°C/second max          |
| Time 25°C to peak Temperature ( $T_p$ )                |                                    | 8 minutes Max.          |
| Do not exceed  |                                    | 280°C                   |



### Physical Specifications

|                        |   |
|------------------------|---|
| <b>Terminal Finish</b> | 100% Matte Tin Plated / Pb-free Solder Dipped                 |
| <b>Body Material</b>   | UL recognized epoxy meeting flammability classification 94V-0 |
| <b>Lead Material</b>   | Copper Alloy  |

### Design Considerations

Careful selection of the correct device for the application's operating parameters and environment will go a long way toward extending the operating life of the Thyristor. Overheating and surge currents are the main killers of SIDACs. Correct mounting, soldering, and forming of the leads also help protect against component damage.

### Reliability/Environmental Tests

| Test                                     | Specifications and Conditions   |
|--|---|
| <b>High Temperature Voltage Blocking</b> | MIL-STD-750: Method 1040, Condition A Rated $V_{DRM}$ (VAC-peak), 125°C, 1008 hours     |
| <b>Temperature Cycling</b>               | MIL-STD-750: Method 1051<br>-40°C to 150°C, 15-minute dwell, 100 cycles                 |
| <b>Biased Temperature &amp; Humidity</b> | EIA/JEDEC: JESD22-A101<br>80% min $V_{BO}$ ( $V_{DC}$ ), 85°C, 85% RH, 1008 hours       |
| <b>High Temp Storage</b>                 | MIL-STD-750: Method 1031<br>150°C, 1008 hours   |
| <b>Low-Temp Storage</b>                  | -40°C, 1008 hours   |
| <b>Thermal Shock</b>                     | MIL-STD-750: Method 1056<br>0°C to 100°C, 5-minute dwell, 10-second transfer, 10 cycles |
| <b>Autoclave (Pressure Cooker Test)</b>  | EIA/JEDEC: JESD22-A102<br>121°C, 100% RH, 2atm, 168 hours                               |
| <b>Resistance to Solder Heat</b>         | MIL-STD-750: Method 2031<br>260°C, 10 seconds   |
| <b>Solderability</b>                     | ANSI/J-STD-002: Category 3  |
| <b>Lead Bend</b>                         | MIL-STD-750: Method 2036, Condition E   |

**Dimensions – DO-214**



| Dimension | Inches |       | Millimeters |      |
|-----------|--------|-------|-------------|------|
|           | Max    | Max   | Min         | Max  |
| A         | 0.130  | 0.156 | 3.30        | 3.95 |
| B         | 0.201  | 0.220 | 5.10        | 5.60 |
| C         | 0.077  | 0.087 | 1.95        | 2.20 |
| D         | 0.159  | 0.181 | 4.05        | 4.60 |
| E         | 0.030  | 0.063 | 0.75        | 1.60 |
| F         | 0.075  | 0.096 | 1.90        | 2.45 |
| G         | 0.002  | 0.008 | 0.05        | 0.20 |
| H         | 0.077  | 0.104 | 1.95        | 2.65 |
| K         | 0.006  | 0.016 | 0.15        | 0.41 |

**Dimensions – DO-15**



| Dimension | Inches |       | Millimeters |       |
|-----------|--------|-------|-------------|-------|
|           | Max    | Max   | Min         | Max   |
| øB        | 0.028  | 0.034 | 0.711       | 0.864 |
| øD        | 0.120  | 0.140 | 3.048       | 3.556 |
| G         | 0.235  | 0.270 | 5.969       | 6.858 |
| L         | 1.000  |       | 25.400      |       |

**Dimensions — TO-92 with Type 70 Lead Form**



| Dimension | Inches |       | Millimeters |      |
|-----------|--------|-------|-------------|------|
|           | Max    | Max   | Min         | Max  |
| A         | 0.176  | 0.196 | 4.47        | 4.98 |
| B         | 0.500  |       | 12.70       |      |
| D         | 0.095  | 0.105 | 2.41        | 2.67 |
| E         | 0.150  |       | 3.81        |      |
| F         | 0.046  | 0.054 | 1.16        | 1.37 |
| G         | 0.135  | 0.145 | 3.43        | 3.68 |
| H         | 0.088  | 0.096 | 2.23        | 2.44 |
| J         | 0.176  | 0.186 | 4.47        | 4.73 |
| K         | 0.088  | 0.096 | 2.23        | 2.44 |
| L         | 0.013  | 0.019 | 0.33        | 0.48 |
| M         | 0.013  | 0.017 | 0.33        | 0.43 |
| N         |        | 0.060 |             | 1.52 |

Notes:

1. Type 70 lead form as shown is standard for the E package.
2. All leads are insulated from case. Case is electrically nonconductive (rated at 16000V ac rms for one minute from leads to case over the operating temperature range.)
3. Mold flash shall not exceed 0.13 mm per side.

**Product Selector**

| Part Number | Switching Voltage Range |                         | Blocking Voltage | Packages |        |          |
|-------------|-------------------------|-------------------------|------------------|----------|--------|----------|
|             | V <sub>BO</sub> Minimum | V <sub>BO</sub> Maximum | V <sub>DRM</sub> | DO-15    | DO-214 | TO-92    |
| K0900y      | 79V                     | 97V                     | 70V              | K0900G   | K0900S | K0900E70 |
| K1050y      | 95V                     | 113V                    | 90V              | K1050G   | K1050S | K1050E70 |
| K1100y      | 104V                    | 118V                    | 90V              | K1100G   | K1100S | K1100E70 |
| K1200y      | 110V                    | 125V                    | 90V              | K1200G   | K1200S | K1200E70 |
| K1300y      | 120V                    | 138V                    | 90V              | K1300G   | K1300S | K1300E70 |
| K1400y      | 130V                    | 146V                    | 90V              | K1400G   | K1400S | K1400E70 |
| K1500y      | 140V                    | 170V                    | 90V              | K1500G   | K1500S | K1500E70 |
| K1800y      | 165V                    | 195V                    | 140V             |          | K1800S |          |
| K2000y      | 190V                    | 215V                    | 180V             | K2000G   | K2000S | K2000E70 |
| K2002y      | 190V                    | 215V                    | 180V             | K2002G   |        |          |
| K2200y      | 205V                    | 230V                    | 180V             | K2200G   | K2200S | K2200E70 |
| K2202y      | 205V                    | 230V                    | 180V             | K2202G   |        |          |
| K2400y      | 220V                    | 250V                    | 190V             | K2400G   | K2400S | K2400E70 |
| K2402y      | 220V                    | 250V                    | 190V             | K2402G   |        |          |
| K2500y      | 240V                    | 280V                    | 200V             | K2500G   | K2500S | K2500E70 |
| K2502y      | 240V                    | 280V                    | 200V             | K2502G   |        |          |
| K3002y      | 270V                    | 330V                    | 200V             | K3002G   |        |          |

Note: y = package



**Packing Options**

| Part Number | Marking | Weight | Packaging Mode | Base Quantity |
|-------------|---------|--------|----------------|---------------|
| Kxxx0G      | Kxxx0G  | 0.38g  | Bulk           | 1000          |
| Kxxx0GRP    | Kxxx0G  | 0.38g  | Reel Pack      | 5000          |
| Kxxx2G      | Kxxx2G  | 0.38g  | Bulk           | 1000          |
| Kxxx2GRP    | Kxxx2G  | 0.38g  | Reel Pack      | 5000          |
| Kxxx0SRP    | KxxS    | 0.1g   | Reel Pack      | 2500          |
| Kxxx0E70    | Kxxx0E  | 0.17g  | Bulk           | 2000          |
| Kxxx0E70AP  | Kxxx0E  | 0.17g  | Ammo Pack      | 2000          |
| Kxxx0E70RP2 | Kxxx0E  | 0.17g  | Reel Pack      | 2000          |
| Kxxx0E70RP3 | Kxxx0E  | 0.17g  | Reel Pack      | 2000          |

Note: xxx or xx = voltage

**DO-214 Embossed Carrier Reel Pack (RP) Specifications**



**DO-15 Reel Pack (RP) Specifications**



**DO-15 Ammo Pack (AP) Specifications**



**TO-92 Type 70 Reel Pack (RP3) Radial Leaded Specifications**



**TO-92 Type 70 Reel Pack (RP2) Radial Leaded Specifications**



**TO-92 Type 70 Ammo Pack (AP) Radial Leaded Specifications**



**Part Numbering System**



**Part Marking System**



## Данный компонент на территории Российской Федерации

### Вы можете приобрести в компании MosChip.

Для оперативного оформления запроса Вам необходимо перейти по данной ссылке:

<http://moschip.ru/get-element>

Вы можете разместить у нас заказ для любого Вашего проекта, будь то серийное производство или разработка единичного прибора.

В нашем ассортименте представлены ведущие мировые производители активных и пассивных электронных компонентов.

Нашей специализацией является поставка электронной компонентной базы двойного назначения, продукции таких производителей как XILINX, Intel (ex.ALTERA), Vicor, Microchip, Texas Instruments, Analog Devices, Mini-Circuits, Amphenol, Glenair.

Сотрудничество с глобальными дистрибьюторами электронных компонентов, предоставляет возможность заказывать и получать с международных складов практически любой перечень компонентов в оптимальные для Вас сроки.

На всех этапах разработки и производства наши партнеры могут получить квалифицированную поддержку опытных инженеров.

Система менеджмента качества компании отвечает требованиям в соответствии с ГОСТ Р ИСО 9001, ГОСТ РВ 0015-002 и ЭС РД 009

### Офис по работе с юридическими лицами:

105318, г.Москва, ул.Щербаковская д.3, офис 1107, 1118, ДЦ «Щербаковский»

Телефон: +7 495 668-12-70 (многоканальный)

Факс: +7 495 668-12-70 (доб.304)

E-mail: [info@moschip.ru](mailto:info@moschip.ru)

Skype отдела продаж:

moschip.ru

moschip.ru\_4

moschip.ru\_6

moschip.ru\_9