



## Main

Range of product	OsiSense XS
Series name	Application
Sensor type	Inductive proximity sensor
Device application	-
Sensor name	XS9
Sensor design	Flat form 26 x 26 x 13
Size	13 mm
Body type	Fixed
Detector flush mounting acceptance	Flush mountable
Material	Plastic
Enclosure material	PBT
Type of output signal	Analogue
Wiring technique	2-wire
[Sn] nominal sensing distance	0.39 in (10 mm)
Discrete output function	1 NO
Output circuit type	DC
Analogue output range	0...10 V
Electrical connection	4 pins M12 remote male connector
Cable length	0.49 ft (0.15 m)
[Us] rated supply voltage	24 V DC
IP degree of protection	IP67 double insulation conforming to IEC 60529

## Complementary

Detection face	Frontal
Front material	PBT
Operating zone	0.04...0.39 in (1...10 mm)
Repeat accuracy	<= 3% of Sr
Linearity error	+/- 1 V
Status LED	Without
Supply voltage limits	15...36 V DC
Switching frequency	<= 1000 Hz
Current consumption	0...4 mAat no-load
Output current drift	<= 10 %
Marking	CE
Depth	0.51 in (13 mm)
Height	1.02 in (26 mm)
Width	1.02 in (26 mm)

## Environment

product certifications	CSA UL Ecolab
ambient air temperature for operation	-13...158 °F (-25...70 °C)
ambient air temperature for storage	-40...185 °F (-40...85 °C)
vibration resistance	25 gn amplitude = +/- 2 mm (f = 10...55 Hz) conforming to IEC 60068-2-6
shock resistance	50 gn 11 ms conforming to IEC 60068-2-27

The information provided in this documentation contains general descriptions and/or technical characteristics of the products contained herein. This documentation is not intended as a substitute for and is not to be used for determining suitability or reliability of these products for specific user applications. It is the duty of any such user or integrator to perform the appropriate and complete risk analysis, evaluation and testing of the products with respect to the relevant specific application or use thereof. Neither Schneider Electric Industries SAS nor any of its affiliates or subsidiaries shall be responsible or liable for misuse of the information contained herein.

## Offer Sustainability

Not Green Premium product	Not Green Premium product
Compliant - since 1104 - Schneider Electric declaration of conformity	Compliant - since 1104 - Schneider Electric declaration of conformity
WARNING: This product can expose you to chemicals including:	WARNING: This product can expose you to chemicals including:
Diisononyl phthalate (DINP), which is known to the State of California to cause cancer, and	Diisononyl phthalate (DINP), which is known to the State of California to cause cancer, and
Di-isodecyl phthalate (DIDP), which is known to the State of California to cause birth defects or other reproductive harm.	Di-isodecyl phthalate (DIDP), which is known to the State of California to cause birth defects or other reproductive harm.
For more information go to <a href="http://www.p65warnings.ca.gov">www.p65warnings.ca.gov</a>	For more information go to <a href="http://www.p65warnings.ca.gov">www.p65warnings.ca.gov</a>

## Contractual warranty

Warranty period	18 months
-----------------	-----------

## Dimensions

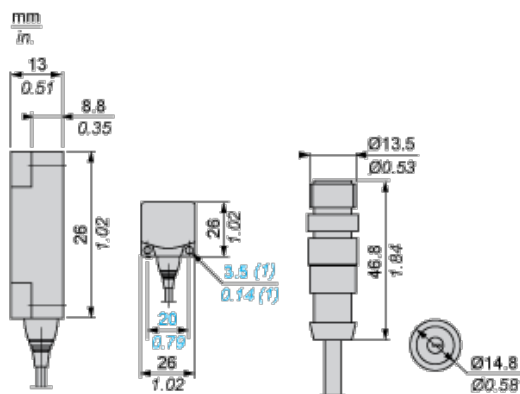

(1) For CHC type screws

## Setting-up

### Minimum Mounting Distances (mm)

#### Side by Side

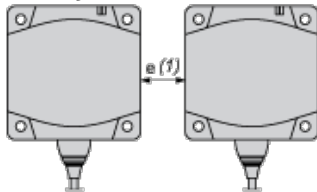

e (1) 30

≥

#### Face to Face

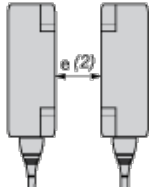

e (2) 72

≥

#### Facing a Metal Object

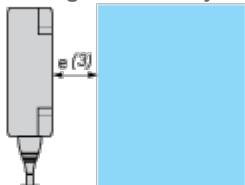

## Wiring Schemes

### 3-Wire Connection

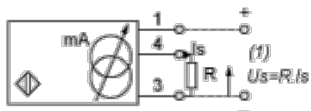

(1) Voltage output

Ensure a minimum of 5 V between the + (terminal 1) and the sensor output (terminal 4)

	Output current	Load impedance value	Output voltage	Load impedance value
24 V	0...10 mA	$R \leq 1400 \Omega$	0...10 V	$R = 1000 \Omega$

M12

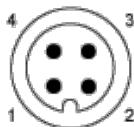

## Output Curves

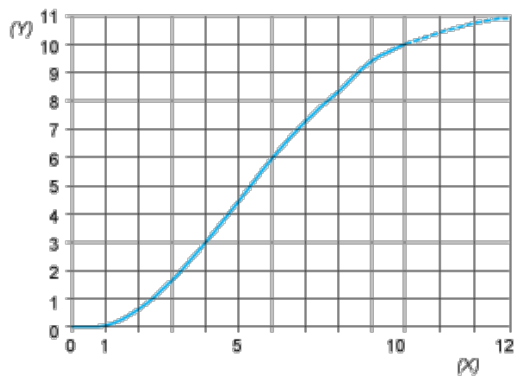

(Y)  $U_s$  (V)

(X) Sensors - object distance (mm)

## Данный компонент на территории Российской Федерации

### Вы можете приобрести в компании MosChip.

Для оперативного оформления запроса Вам необходимо перейти по данной ссылке:

<http://moschip.ru/get-element>

Вы можете разместить у нас заказ для любого Вашего проекта, будь то серийное производство или разработка единичного прибора.

В нашем ассортименте представлены ведущие мировые производители активных и пассивных электронных компонентов.

Нашей специализацией является поставка электронной компонентной базы двойного назначения, продукции таких производителей как XILINX, Intel (ex.ALTERA), Vicor, Microchip, Texas Instruments, Analog Devices, Mini-Circuits, Amphenol, Glenair.

Сотрудничество с глобальными дистрибьюторами электронных компонентов, предоставляет возможность заказывать и получать с международных складов практически любой перечень компонентов в оптимальные для Вас сроки.

На всех этапах разработки и производства наши партнеры могут получить квалифицированную поддержку опытных инженеров.

Система менеджмента качества компании отвечает требованиям в соответствии с ГОСТ Р ИСО 9001, ГОСТ РВ 0015-002 и ЭС РД 009

### Офис по работе с юридическими лицами:

105318, г.Москва, ул.Щербаковская д.3, офис 1107, 1118, ДЦ «Щербаковский»

Телефон: +7 495 668-12-70 (многоканальный)

Факс: +7 495 668-12-70 (доб.304)

E-mail: [info@moschip.ru](mailto:info@moschip.ru)

Skype отдела продаж:

moschip.ru

moschip.ru\_4

moschip.ru\_6

moschip.ru\_9