

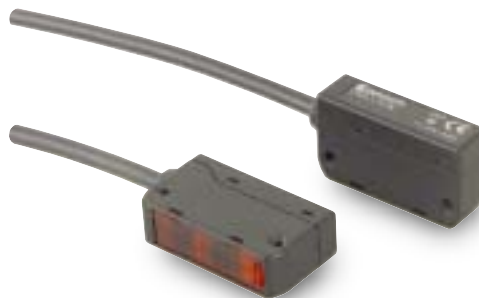

Reliable Detection Unaffected by PCB Holes or Notches

- High-limit E3S-LS3□ is suitable for incorporation in devices.
- Wide-range E3S-LS3□W is ideal for detecting tall components mounted on boards.
- Timer function models available.





 Be sure to read *Safety Precautions* on page 4.

Ordering Information

Sensors

 Red light

Sensing method	Appearance	Connection method	Sensing distance	Timer function	Model	
					NPN output	PNP output
Convergent-reflective		Pre-wired (2 m)	 20 to 35 mm *	Without	E3S-LS3N 2M	E3S-LS3P 2M
				With	E3S-LS3NT 2M	E3S-LS3PT 2M
			 10 to 60 mm *	Without	E3S-LS3NW 2M	E3S-LS3PW 2M
			With	E3S-LS3NWT 2M	E3S-LS3PWT 2M	

* For white paper: 80 × 80 mm.

Ratings and Specifications

Item	Sensing method Model	Convergent-reflective	
		E3S-LS3N(T)/-LS3P(T)	E3S-LS3NW(T)/-LS3PW(T)
Sensing distance	White paper *	20 to 35 mm	10 to 60 mm
	Black paper *	20 to 30 mm	15 to 50 mm
Light source (wavelength)		Red LED (660 nm)	
Power supply voltage		12 to 24 VDC±10%, ripple (p-p) 10% max.	
Current consumption		25 mA max.	
Control output		Load power supply voltage: 24 VDC max., Load current: 100 mA max., (Residual voltage: 1 V max. for NPN output or 2 V max. for PNP output) Open collector output configuration: NPN or PNP output depending on the model, Operating mode: Light-ON	
Response time		Operate or reset: 1 ms max.	
Timer function (only models with timer function)		OFF-delay range: 0.1 to 1.0 s (adjustable)	
Ambient illumination (Receiver side)		Incandescent lamp: 5,000 lux max.	
Ambient temperature range		Operating: -10 to 55°C (with no icing or condensation) Storage: -25 to 70°C (with no icing or condensation)	
Ambient humidity range		Operating: 35% to 85% (with no condensation) Storage: 35% to 95% (with no condensation)	
Insulation resistance		20 MΩ min. (at 500 VDC)	
Dielectric strength		1,000 VAC at 50/60 Hz for 1 minute	
Vibration resistance		Destruction: 10 to 55 Hz with a 1.5-mm double amplitude for 2 hrs each in X, Y and Z directions	
Shock resistance		Destruction: 500 m/s ² , 3 times each in X, Y and Z directions	
Degree of protection		IEC 60529 IP40	
Connection method		Pre-wired (standard length: 2 m)	
Weight (packed state)		Approx. 80 g	
Material	Case	ABS (Acrylonitril Butadiene Styrene)	
	Lens	Methacrylic resin	
Accessories		Instruction manual, M3 screws, Adjustment screwdriver (only models with timer function)	

* For 80 × 80 mm.

Engineering Data (Typical)

Sensing Distance vs. Materials

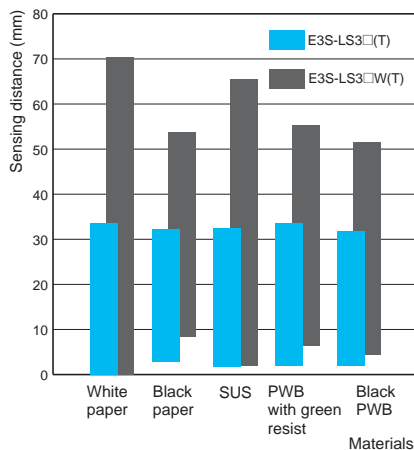

Operating Range (Left and Right)

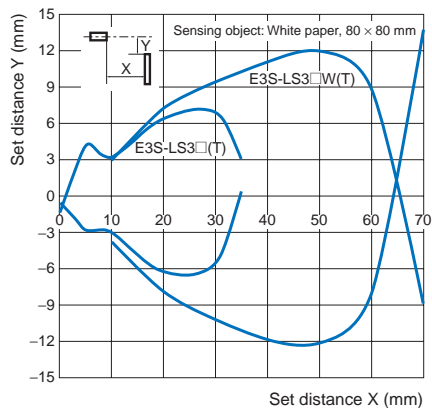

Operating Range (Up and Down)

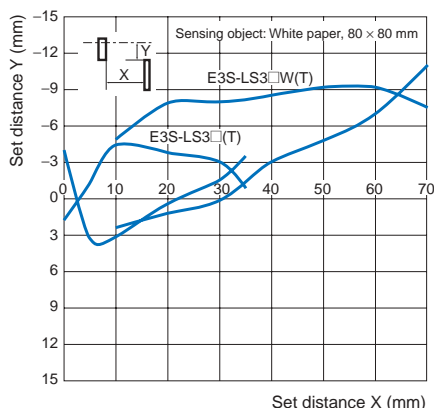

Excess Gain vs. Set Distance

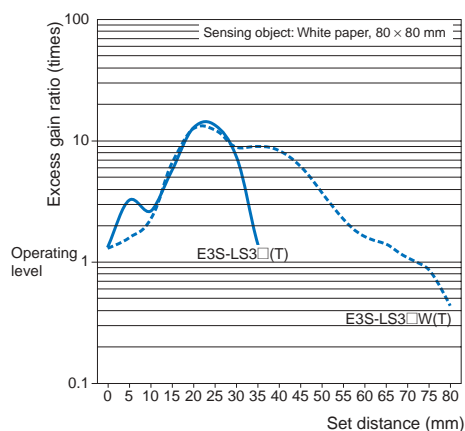

Spot Diameter vs. Sensing Distance

(E3S-LS3□(T), E3S-LS3□W(T) (Common))

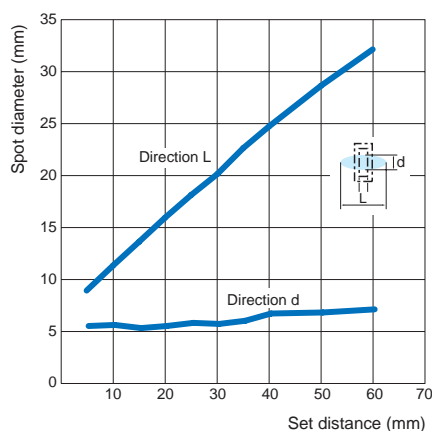











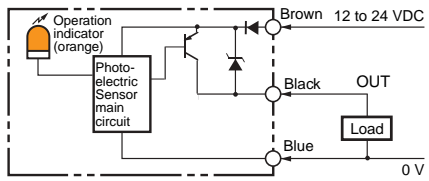

I/O Circuit Diagrams

NPN Output

Model	Operation mode	Timing charts	Output circuit
E3S-LS3N E3S-LS3NW	Light-ON	Incident light: ON (green bar), OFF (white bar) No incident light: OFF (white bar) Operation indicator (orange): ON (green bar), OFF (white bar) Output transistor: ON (green bar), OFF (white bar)	
E3S-LS3NT E3S-LS3NWT		Incident light: ON (green bar), OFF (white bar) with a delay timer 'T' indicated. No incident light: OFF (white bar) Operation indicator (orange): ON (green bar), OFF (white bar) Output transistor: ON (green bar), OFF (white bar)	

PNP Output

Model	Operation mode	Timing charts	Output circuit
E3S-LS3P E3S-LS3PW	Light-ON	Incident light  No incident light  Operation indicator (orange) ON  OFF  Output transistor ON  OFF 	
E3S-LS3PT E3S-LS3PWT		Incident light  No incident light  Operation indicator (orange) ON  OFF  Output transistor ON  OFF  T: OFF-delay timer (0.1 to 1.0 s)	

Safety Precautions

Refer to *Warranty and Limitations of Liability*.

⚠ WARNING

This product is not designed or rated for ensuring safety of persons either directly or indirectly. Do not use it for such purposes.



Precautions for Correct Use

Do not use the product in atmospheres or environments that exceed product ratings

Dimensions

(Unit: mm)

Tolerance class IT16 applies to dimensions in this datasheet unless otherwise specified.

E3S-LS3N(T)/E3S-LS3P(T)
E3S-LS3NW(T)/E3S-LS3PW(T)

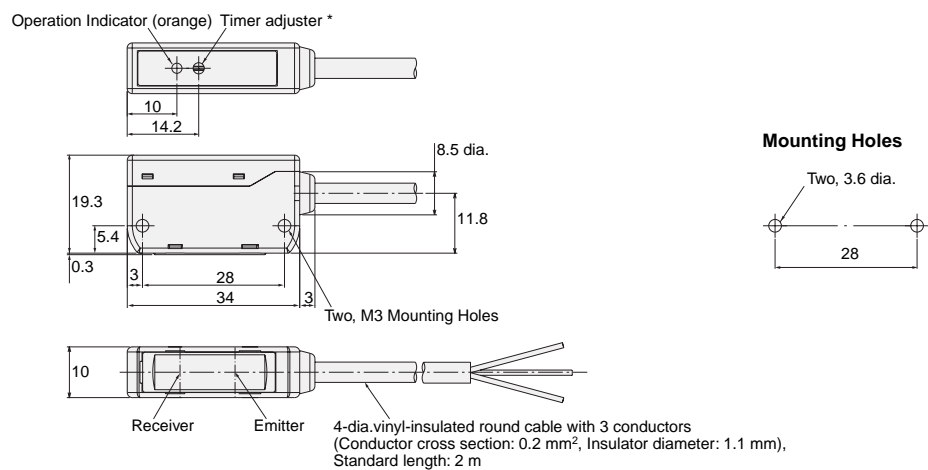

* The timer adjuster is only for models with the timer function.

Read and Understand This Catalog

Please read and understand this catalog before purchasing the products. Please consult your OMRON representative if you have any questions or comments.

Warranty and Limitations of Liability

WARRANTY

OMRON's exclusive warranty is that the products are free from defects in materials and workmanship for a period of one year (or other period if specified) from date of sale by OMRON.

OMRON MAKES NO WARRANTY OR REPRESENTATION, EXPRESS OR IMPLIED, REGARDING NON-INFRINGEMENT, MERCHANTABILITY, OR FITNESS FOR PARTICULAR PURPOSE OF THE PRODUCTS. ANY BUYER OR USER ACKNOWLEDGES THAT THE BUYER OR USER ALONE HAS DETERMINED THAT THE PRODUCTS WILL SUITABLY MEET THE REQUIREMENTS OF THEIR INTENDED USE. OMRON DISCLAIMS ALL OTHER WARRANTIES, EXPRESS OR IMPLIED.

LIMITATIONS OF LIABILITY

OMRON SHALL NOT BE RESPONSIBLE FOR SPECIAL, INDIRECT, OR CONSEQUENTIAL DAMAGES, LOSS OF PROFITS OR COMMERCIAL LOSS IN ANY WAY CONNECTED WITH THE PRODUCTS, WHETHER SUCH CLAIM IS BASED ON CONTRACT, WARRANTY, NEGLIGENCE, OR STRICT LIABILITY.

In no event shall the responsibility of OMRON for any act exceed the individual price of the product on which liability is asserted.

IN NO EVENT SHALL OMRON BE RESPONSIBLE FOR WARRANTY, REPAIR, OR OTHER CLAIMS REGARDING THE PRODUCTS UNLESS OMRON'S ANALYSIS CONFIRMS THAT THE PRODUCTS WERE PROPERLY HANDLED, STORED, INSTALLED, AND MAINTAINED AND NOT SUBJECT TO CONTAMINATION, ABUSE, MISUSE, OR INAPPROPRIATE MODIFICATION OR REPAIR.

Application Considerations

SUITABILITY FOR USE

OMRON shall not be responsible for conformity with any standards, codes, or regulations that apply to the combination of products in the customer's application or use of the products.

At the customer's request, OMRON will provide applicable third party certification documents identifying ratings and limitations of use that apply to the products. This information by itself is not sufficient for a complete determination of the suitability of the products in combination with the end product, machine, system, or other application or use.

The following are some examples of applications for which particular attention must be given. This is not intended to be an exhaustive list of all possible uses of the products, nor is it intended to imply that the uses listed may be suitable for the products:

- Outdoor use, uses involving potential chemical contamination or electrical interference, or conditions or uses not described in this catalog.
- Nuclear energy control systems, combustion systems, railroad systems, aviation systems, medical equipment, amusement machines, vehicles, safety equipment, and installations subject to separate industry or government regulations.
- Systems, machines, and equipment that could present a risk to life or property.

Please know and observe all prohibitions of use applicable to the products.

NEVER USE THE PRODUCTS FOR AN APPLICATION INVOLVING SERIOUS RISK TO LIFE OR PROPERTY WITHOUT ENSURING THAT THE SYSTEM AS A WHOLE HAS BEEN DESIGNED TO ADDRESS THE RISKS, AND THAT THE OMRON PRODUCTS ARE PROPERLY RATED AND INSTALLED FOR THE INTENDED USE WITHIN THE OVERALL EQUIPMENT OR SYSTEM.

PROGRAMMABLE PRODUCTS

OMRON shall not be responsible for the user's programming of a programmable product, or any consequence thereof.

Disclaimers

CHANGE IN SPECIFICATIONS

Product specifications and accessories may be changed at any time based on improvements and other reasons.

It is our practice to change model numbers when published ratings or features are changed, or when significant construction changes are made. However, some specifications of the products may be changed without any notice. When in doubt, special model numbers may be assigned to fix or establish key specifications for your application on your request. Please consult with your OMRON representative at any time to confirm actual specifications of purchased products.

DIMENSIONS AND WEIGHTS

Dimensions and weights are nominal and are not to be used for manufacturing purposes, even when tolerances are shown.

PERFORMANCE DATA

Performance data given in this catalog is provided as a guide for the user in determining suitability and does not constitute a warranty. It may represent the result of OMRON's test conditions, and the users must correlate it to actual application requirements. Actual performance is subject to the OMRON Warranty and Limitations of Liability.

ERRORS AND OMISSIONS

The information in this document has been carefully checked and is believed to be accurate; however, no responsibility is assumed for clerical, typographical, or proofreading errors, or omissions.

2008.11

In the interest of product improvement, specifications are subject to change without notice.

OMRON Corporation
Industrial Automation Company

<http://www.ia.omron.com/>

(c)Copyright OMRON Corporation 2008 All Right Reserved.

Данный компонент на территории Российской Федерации

Вы можете приобрести в компании MosChip.

Для оперативного оформления запроса Вам необходимо перейти по данной ссылке:

<http://moschip.ru/get-element>

Вы можете разместить у нас заказ для любого Вашего проекта, будь то серийное производство или разработка единичного прибора.

В нашем ассортименте представлены ведущие мировые производители активных и пассивных электронных компонентов.

Нашей специализацией является поставка электронной компонентной базы двойного назначения, продукции таких производителей как XILINX, Intel (ex.ALTERA), Vicor, Microchip, Texas Instruments, Analog Devices, Mini-Circuits, Amphenol, Glenair.

Сотрудничество с глобальными дистрибьюторами электронных компонентов, предоставляет возможность заказывать и получать с международных складов практически любой перечень компонентов в оптимальные для Вас сроки.

На всех этапах разработки и производства наши партнеры могут получить квалифицированную поддержку опытных инженеров.

Система менеджмента качества компании отвечает требованиям в соответствии с ГОСТ Р ИСО 9001, ГОСТ РВ 0015-002 и ЭС РД 009

Офис по работе с юридическими лицами:

105318, г.Москва, ул.Щербаковская д.3, офис 1107, 1118, ДЦ «Щербаковский»

Телефон: +7 495 668-12-70 (многоканальный)

Факс: +7 495 668-12-70 (доб.304)

E-mail: info@moschip.ru

Skype отдела продаж:

moschip.ru

moschip.ru_4

moschip.ru_6

moschip.ru_9