

## Interactive Catalog Supplements Catalog PDFs

If you need detailed product information, or help choosing the right product for your application, see our [Interactive Catalog](#). Use the [Interactive Catalog](#) to access the most complete and up-to-date information available.

The [Interactive Catalog](#) provides an extensive collection of product specifications, application data, and technical literature that can be searched based on criteria you select.

This PDF catalog information was published in November 2000.



Sensing and Control  
[Interactive Catalog...](#)

**Click this icon to try  
the Interactive Catalog.**

---

### Sensing and Control

Honeywell Inc.

11 West Spring Street

Freeport, IL 61032

# Manual Switches

## Rocker Button Switches

TP Series

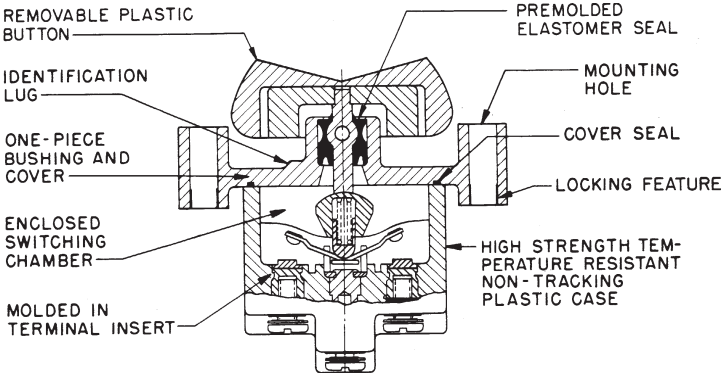

UL/CSA Rating Code	Electrical Rating
L192	10 amps-125, 250, 277 VAC; 1/4 Hp-125 VAC; 1/2 Hp-250, 277 VAC 3 Amps-125 VAC "L"
L191	15 amps-125, 250, 277 VAC; 1/2 Hp-125 VAC; 1Hp-250, 277 VAC 5 amps-120 VAC "L"

**Application Note:** Honeywell MICRO SWITCH does *not* recommend the use of silver cadmium oxide switch contacts in non-arcing loads. Non-arcing loads are generally loads less than 12 volts and/or 0.5 amp. TP switches use silver cadmium oxide contacts. For other options, contact the MICRO SWITCH Application Center at 1-800-537-6945.

### FEATURES

- 2 and 3 position pushbutton action
- Various button colors
- 1, 2, and 4 pole circuitry
- Flush panel and above panel mounting
- Temperature range is from -65°F to +160°F (-54°C to +71°C)
- UL recognized, CSA certified
- CE approved

### CONSTRUCTION

Above panel mounting gives a distinct button appearance. Flush panel mounting presents a low button profile.

### TERMINAL CIRCUIT IDENTIFICATION

Terminal identifications are referred to in the order guides to indicate which circuits are made in each toggle position (i.e., 1-2 indicates circuit closure through terminals 1 and 2).

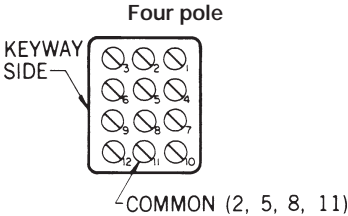
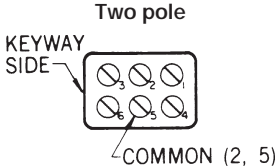
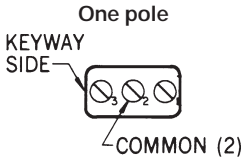

Toggle/Rockers

# Manual Switches

## Rocker Button Switches



Typical two-pole flush panel translucent button switch



Typical one-pole above panel transparent button switch

### BUTTON OPTIONS

Buttons are removable and interchangeable. They measure .87" x 1.46" (22,1 x 37,1 mm).

**Transparent** (colorless plastic) buttons accept under-the-surface legend inserts for station and function identification. **Legend inserts are not furnished.** Insert legending can be done by your local supplier.

**Translucent** (white plastic) buttons have a clear appearance.

**Colored** (opaque plastic) buttons are excellent for color coding switch functions.

### SWITCHES WITHOUT BUTTONS

To order switches without buttons, convert catalog listings shown in the order guides. Substitute **TP7** for TP4 and TP16 above panel mounted switches; substitute **TP8** for TP201 and TP12 flush panel mounted switches. Order buttons separately from the chart below.

### BUTTON ORDER GUIDE

Color	Catalog Listing
Translucent	12PA6
Transparent	12PA4
White*	12PA5-W
Yellow*	12PA5-Y
Black*	12PA5-BK
Green*	12PA5-G
Red*	12PA5-R
Blue*	12PA5-BL

\* Opaque

### 2-POSITION ORDER GUIDE

Furnished with buttons.

No. of Poles	Circuits Made with Button at:		UL/CSA Rating Code	Elec. Rating Code	Catalog Listings			
	Ident. Lug Position	Opposite Ident. Lug			Flush Panel		Above Panel	
					Translucent Button	Transparent Button	Translucent Button	Transparent Button
1	OFF	2-3	L191	1	1TP201-2	1TP12-2	1TP216-2	1TP4-2
	OFF*	2-3	L192	2	1TP201-4	—	—	—
	1-2*	OFF	L192	2	1TP201-6	1TP12-6	—	1TP4-6
	1-2	2-3	L191	1	1TP201-3	1TP12-3	1TP216-3	1TP4-3
	1-2*	2-3	L192	2	1TP201-8	1TP12-8	1TP216-8	—
2	OFF	2-3, 5-6	L191	3	2TP201-2	2TP12-2	2TP216-2	2TP4-2
	1-2,4-5	2-3, 5-6	L191	3	2TP201-3	2TP12-3	2TP216-3	2TP4-3
	1-2,4-5*	2-3, 5-6	L192	4	2TP201-8	2TP12-8	2TP216-8	2TP4-8
4	OFF	2-3, 5-6, 8-9, 11-12	L191	5	4TP201-2	4TP12-2	—	—
	OFF*	2-3, 5-6, 8-9, 11-12	L192	6	—	—	4TP216-4	—
	1-2, 4-5, 7-8, 10-11	2-3, 5-6, 8-9, 11-12	L191	5	4TP201-3	4TP12-3	4TP216-3	4TP4-3
	1-2, 4-5, 7-8, 10-11*	2-3, 5-6, 8-9, 11-12	L192	6	—	—	4TP216-8	—

\* These positions only are momentary. All others are maintained.

# Manual Switches

## Rocker Button Switches

TP Series

### 3 - POSITION ORDER GUIDE

Furnished with buttons.

No. of Poles	Circuits Made with Button at:			UL/CSA Rating Code	Elec. Rating Code	Catalog Listings			
	Ident. Lug Position	Center Position	Opposite Lug Position			Flush Panel		Above Panel	
						Translucent Button	Transparent Button	Translucent Button	Transparent Button
1	1-2	OFF	2-3	L191	1	1TP201-1	1TP12-1	1TP216-1	1TP4-1
	1-2*	OFF	2-3	L192	2	1TP201-5	1TP12-5	1TP216-5	1TP4-5
	1-2*	OFF	2-3*	L192	2	1TP201-7	1TP12-7	1TP216-7	1TP4-7
	NONE**	OFF	2-3	L191	1	1TP201-21	1TP12-21	—	1TP4-21
	NONE**	1-2	2-3	L191	1	1TP201-31	1TP12-31	—	1TP4-31
	NONE**	1-2	2-3*	L192	2	1TP201-51	1TP12-51	1TP216-51	1TP4-51
	1-2*	OFF	NONE**	L192	2	1TP201-61	1TP12-61	1TP216-61	1TP4-61
2	1-2, 4-5	OFF	2-3, 5-6	L191	3	2TP201-1	2TP12-1	2TP216-1	2TP4-1
	1-2, 4-5*	OFF	2-3, 5-6	L192	4	2TP201-5	2TP12-5	2TP216-5	2TP4-5
	1-2, 4-5*	OFF	2-3, 5-6*	L192	4	2TP201-7	2TP12-7	2TP216-7	2TP4-7
	NONE**	OFF	2-3, 5-6	L191	3	2TP201-21	2TP12-21	2TP216-21	2TP4-21
	NONE**	1-2, 4-5	2-3, 5-6	L191	3	2TP201-31	2TP12-31	2TP216-31	2TP4-31
	NONE**	1-2, 4-5	2-3, 5-6*	L192	4	2TP201-512	2TP12-512	2TP216-512	2TP4-512
	1-2, 4-5*	OFF	NONE**	L192	4	2TP201-61	2TP12-61	2TP216-61	2TP4-61
	1-2, 4-5	1-2, 5-6	2-3, 5-6	L191	3	2TP201-10†	2TP12-10	2TP216-10	2TP4-10
	1-2, 4-5*	1-2, 5-6	2-3, 5-6	L192	4	2TP201-50†	2TP12-50	2TP216-50	2TP4-50
	1-2, 4-5*	1-2, 5-6	2-3, 5-6*	L192	4	2TP201-70†	2TP12-70	2TP216-70	2TP4-70
4	1-2, 4-5, 7-8, 10-11	OFF	2-3, 5-6 8-9, 11-12	L191	5	4TP201-1	4TP12-1	4TP216-1	4TP4-1
	1-2, 4-5 7-8, 10-11*	OFF	2-3, 5-6 8-9, 11-12	L192	6	4TP201-5	4TP12-5	—	4TP4-5
	1-2, 4-5, 7-8, 10-11*	OFF	2-3, 5-6 8-9, 11-12*	L192	6	4TP201-7	4TP12-7	4TP216-7	4TP4-7
	NONE**	OFF	2-3, 5-6, 8-9, 11-12	L191	5	4TP201-21	4TP12-21	4TP216-21	4TP4-21
	NONE**	1-2, 4-5 7-8, 10-11	2-3, 5-6, 8-9, 11-12	L191	5	4TP201-31	—	4TP216-31	4TP4-31
	NONE**	1-2, 4-5 7-8, 10-11	2-3, 5-6 8-9, 11-12*	L192	6	4TP201-51	—	4TP216-51	4TP4-51
	1-2, 4-5, 7-8, 10-11*	OFF	NONE**	L192	6	4TP201-61	4TP12-61	4TP216-61	4TP4-61
	1-2, 4-5, 7-8, 10-11	2-3, 4-5	2-3, 5-6, 8-9, 11-12	L191	5	4TP201-10†	4TP12-10	—	4TP4-10
	1-2, 4-5, 7-8, 10-11*	2-3, 4-5 7-8, 11-12	2-3, 5-6, 8-9, 11-12	L192	6	4TP201-50†	4TP12-50	4TP216-50	4TP4-50
1-2, 4-5, 7-8, 10-11*	2-3, 4-5	2-3, 5-6, 8-9, 11-12*	L192	6	4TP201-70†	4TP12-70	4TP216-70	4TP4-70	

\*These positions only are momentary. All others are maintained.

\*\*Operator is blocked from these positions. Switch becomes two position, with center being one extreme position.

† Special on-on-on circuitry. See page 123.

Toggle/Rockers

# Manual Switches

## Rocker Button Switches

TP Series

MOUNTING DIMENSIONS (For reference only)

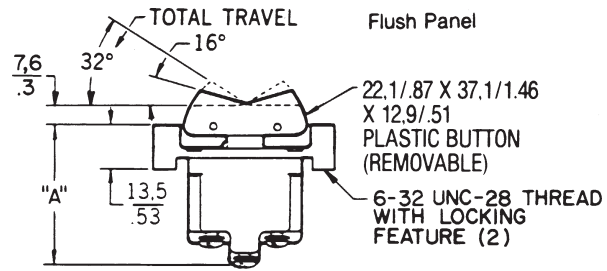
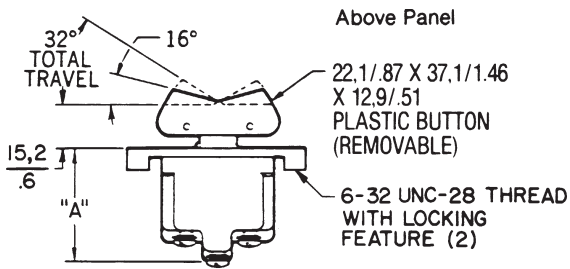

DIM. "A"	
1-POLE	29,5 / 1.16
2 & 4-POLE	34,4 / 1.35

DIM. "A"	
1-POLE	36,8 / 1.45
2 & 4-POLE	41,7 / 1.64

Panel cutout

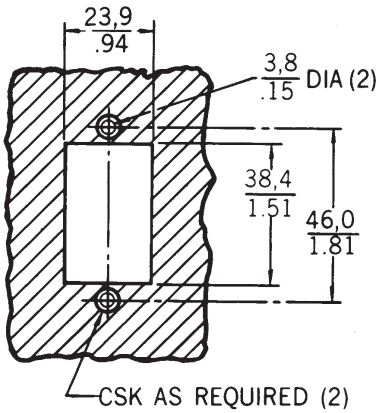

Key:  $\frac{0,0}{0.00} = \text{mm}$   
 $\frac{0,00}{0.00} = \text{inches}$

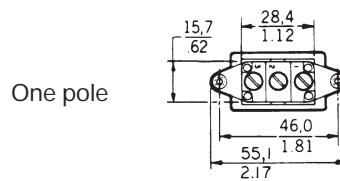

One pole

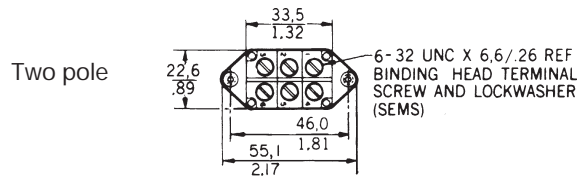

Two pole

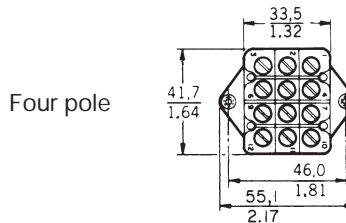

Four pole

Flange mounting torque is 10-12 in./lbs.  
 Terminal screw mounting torque is 5 in./lbs. max.

## Данный компонент на территории Российской Федерации

### Вы можете приобрести в компании MosChip.

Для оперативного оформления запроса Вам необходимо перейти по данной ссылке:

<http://moschip.ru/get-element>

Вы можете разместить у нас заказ для любого Вашего проекта, будь то серийное производство или разработка единичного прибора.

В нашем ассортименте представлены ведущие мировые производители активных и пассивных электронных компонентов.

Нашей специализацией является поставка электронной компонентной базы двойного назначения, продукции таких производителей как XILINX, Intel (ex.ALTERA), Vicor, Microchip, Texas Instruments, Analog Devices, Mini-Circuits, Amphenol, Glenair.

Сотрудничество с глобальными дистрибьюторами электронных компонентов, предоставляет возможность заказывать и получать с международных складов практически любой перечень компонентов в оптимальные для Вас сроки.

На всех этапах разработки и производства наши партнеры могут получить квалифицированную поддержку опытных инженеров.

Система менеджмента качества компании отвечает требованиям в соответствии с ГОСТ Р ИСО 9001, ГОСТ РВ 0015-002 и ЭС РД 009

### Офис по работе с юридическими лицами:

105318, г.Москва, ул.Щербаковская д.3, офис 1107, 1118, ДЦ «Щербаковский»

Телефон: +7 495 668-12-70 (многоканальный)

Факс: +7 495 668-12-70 (доб.304)

E-mail: [info@moschip.ru](mailto:info@moschip.ru)

Skype отдела продаж:

moschip.ru

moschip.ru\_4

moschip.ru\_6

moschip.ru\_9