

SMD Multilayer Chip Bead

ACML-0201

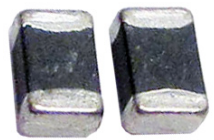

RoHS
Compliant



0.6 x 0.3 x 0.3 mm

FEATURES:

- Internal silver printed layers and magnetically shielded to minimize crosstalk
- Substantial EMI suppression over a wide frequency range
- Excellent solderability and heat resistance

APPLICATIONS:

- Noise suppression for computers and peripheral devices, DVD cameras, LCD TVs, communication equipments, OA equipments, etc.
- Reduces noise in ultra high speed circuits as well

STANDARD SPECIFICATIONS:

Operating Temperature: -55°C ~ +125°C

Storage Temperature: -10°C to +40°C, 70% RH max

Part No.	Z(Ω) ± 25%	Z Test Freq.	DCR (Ω)	Ir (mA)
		(MHz)	(max)	(max)
ACML-0201-600	60	100	0.40	200
ACML-0201-800	80	100	0.60	200
ACML-0201-121	120	100	0.80	200
ACML-0201-241	240	100	1.00	200
ACML-0201-471	470	100	1.40	200
ACML-0201-601	600	100	1.70	200

Test Conditions and equipments

Z: High Accuracy RF Impedance/Material Analyzer -E4991A, 100MHz, -20dBm or 50mV

DCR: High Accuracy Milliohmmeter –HP4338B

Ir: Electric Power Supply, Electric Current Meter, Thermometer. $\Delta T \leq 20^\circ C$

Unless otherwise specified, the standard atmospheric conditions for measurement/test as:

- Ambient Temperature: 20±15°C
- Relative Humidity: 65%±20%
- Air Pressure: 86 KPa to 106 KPa

Visual Examination

- Inspection Equipment: 20X magnifier

OPTIONS AND PART IDENTIFICATION:

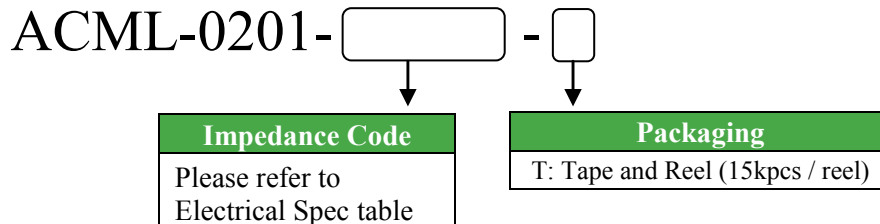

SMD Multilayer Chip Bead

ACML-0201



RoHS
Compliant

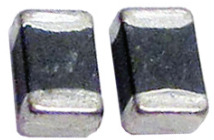

0.6 x 0.3 x 0.3 mm

FREQUENCY RESPONSE

ACML-0201-600

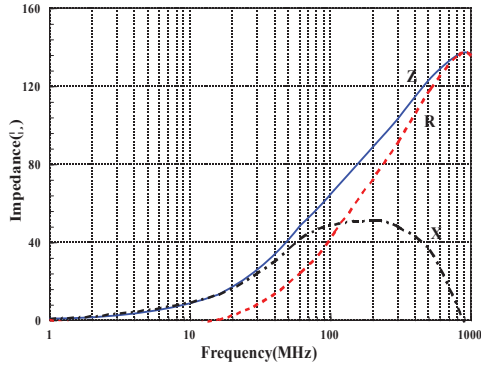

ACML-0201-800

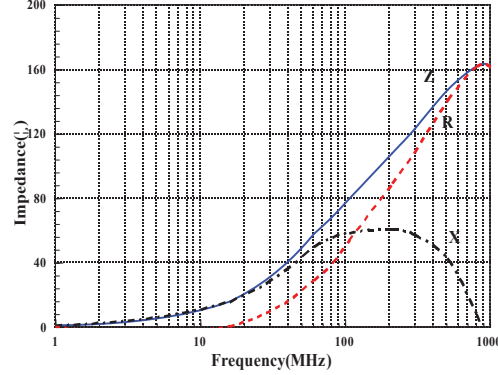

ACML-0201-121

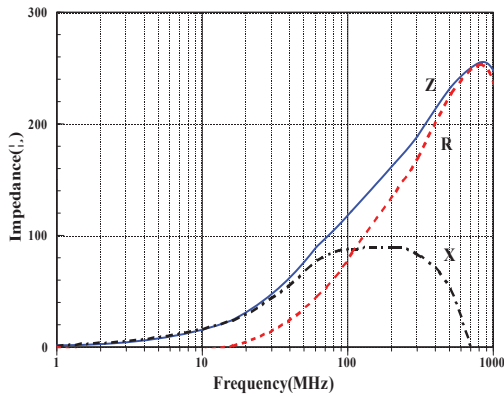

ACML-0201-241

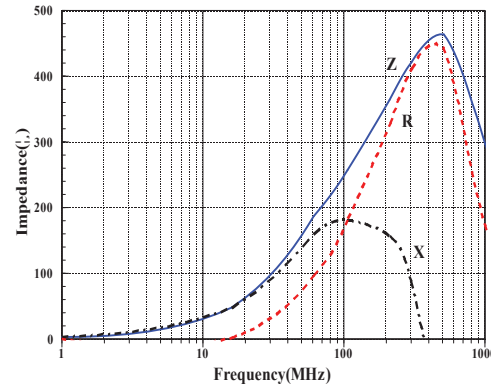

ACML-0201-471

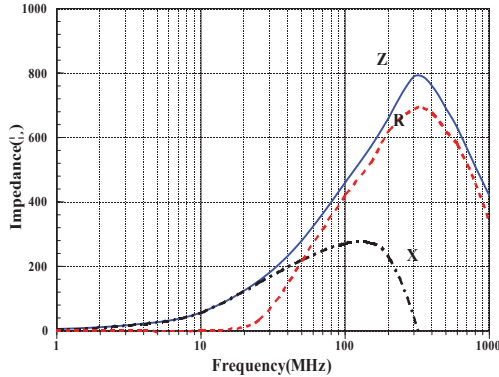

ACML-0201-601

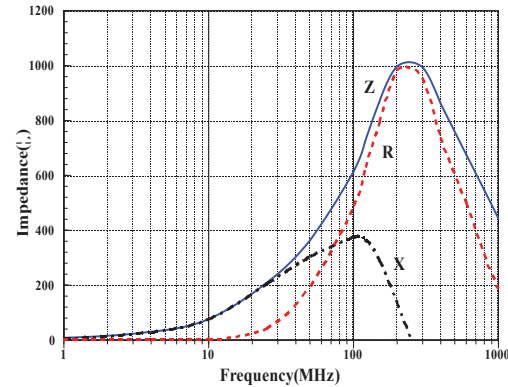

SMD Multilayer Chip Bead

ACML-0201



RoHS
Compliant



0.6 x 0.3 x 0.3 mm

OUTLINE DRAWING:

Recommended Land Pattern

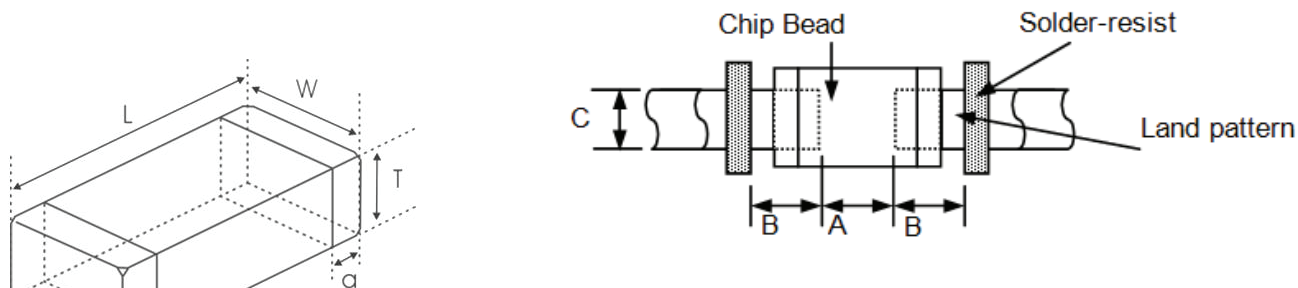

A	B	C
0.2~0.3	0.2~0.3	0.3~0.35

Series	L	W	T	a
ACML-0201	0.6±0.05 [0.024±0.002]	0.3±0.05 [0.012±0.002]	0.3±0.05 [0.012±0.002]	0.15±0.05 [0.006±0.002]

Dimension: mm [inch]

Materials

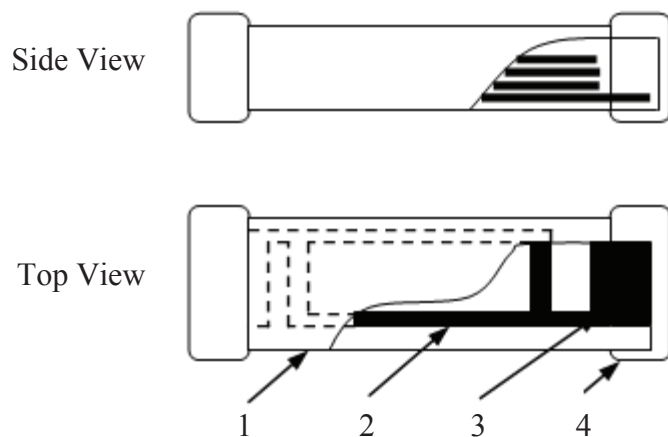

	Part Name	Material
1	Base Material	Ferrite
2	Internal Conductor	Ag
3	Pull out Electrode	Ag
4	Terminal Electrode	Ag (Inner layer) Ni-Sn (Outer layer)

SMD Multilayer Chip Bead

ACML-0201



RoHS
Compliant

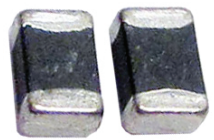

0.6 x 0.3 x 0.3 mm

REFLOW PROFILE:

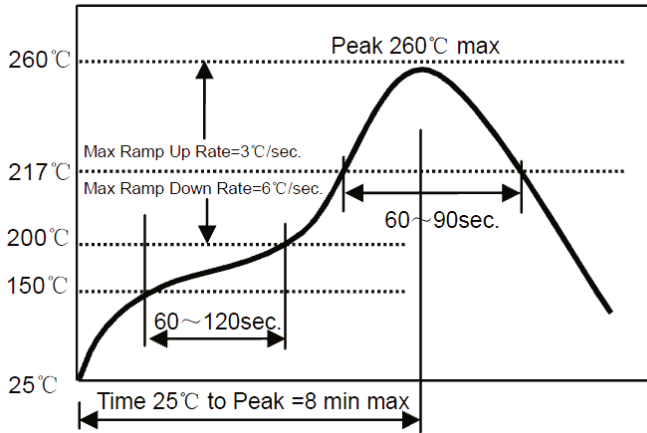

Preheat Condition	150 to 200 °C; 60 to 120 sec.
Albwd time above 217 °C	60 to 90 sec.
Max temperature	260 °C
Max time at max temperature	10 sec.
Solder paste	Sn/3.0Ag/0.5Cu
Allowed Reflow time	2x max.

TAPE & REEL:

T: 15,000pcs / reel

Sprocket Hole $\Phi 1.5 (+0.1, -0.0)$

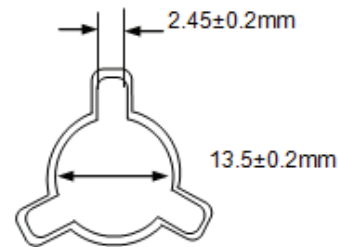
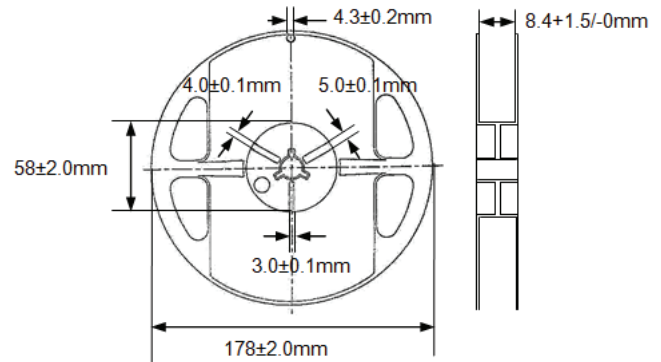
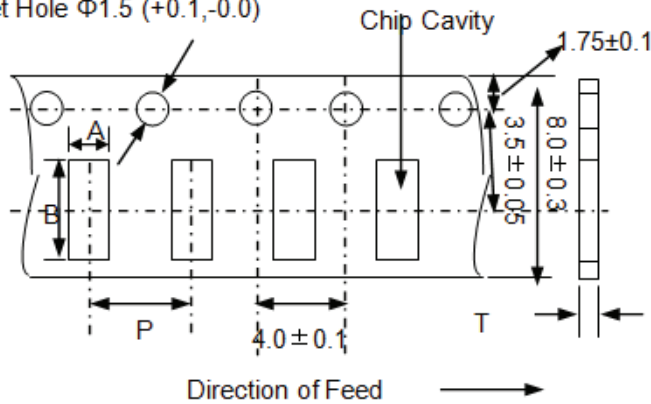

A	B	P	t(max)
0.40±0.1	0.70±0.1	2.0±0.1	0.55

Dimension: mm

ATTENTION: Abracon Corporation's products are COTS – Commercial-Off-The-Shelf products; suitable for Commercial, Industrial and, where designated, Automotive Applications. Abracon's products are not specifically designed for Military, Aviation, Aerospace, Life-dependant Medical applications or any application requiring high reliability where component failure could result in loss of life and/or property. For applications requiring high reliability and/or presenting an extreme operating environment, written consent and authorization from Abracon Corporation is required. Please contact Abracon Corporation for more information.

ABRACON IS
ISO 9001:2008
CERTIFIED



ABRACON
CORPORATION

Visit www.abracon.com for Terms & Conditions of Sale **Revised: 09.12.12**
30332 Esperanza, Rancho Santa Margarita, California 92688
tel 949-546-8000 | fax 949-546-8001 | www.abracon.com

Данный компонент на территории Российской Федерации

Вы можете приобрести в компании MosChip.

Для оперативного оформления запроса Вам необходимо перейти по данной ссылке:

<http://moschip.ru/get-element>

Вы можете разместить у нас заказ для любого Вашего проекта, будь то серийное производство или разработка единичного прибора.

В нашем ассортименте представлены ведущие мировые производители активных и пассивных электронных компонентов.

Нашей специализацией является поставка электронной компонентной базы двойного назначения, продукции таких производителей как XILINX, Intel (ex.ALTERA), Vicor, Microchip, Texas Instruments, Analog Devices, Mini-Circuits, Amphenol, Glenair.

Сотрудничество с глобальными дистрибьюторами электронных компонентов, предоставляет возможность заказывать и получать с международных складов практически любой перечень компонентов в оптимальные для Вас сроки.

На всех этапах разработки и производства наши партнеры могут получить квалифицированную поддержку опытных инженеров.

Система менеджмента качества компании отвечает требованиям в соответствии с ГОСТ Р ИСО 9001, ГОСТ РВ 0015-002 и ЭС РД 009

Офис по работе с юридическими лицами:

105318, г.Москва, ул.Щербаковская д.3, офис 1107, 1118, ДЦ «Щербаковский»

Телефон: +7 495 668-12-70 (многоканальный)

Факс: +7 495 668-12-70 (доб.304)

E-mail: info@moschip.ru

Skype отдела продаж:

moschip.ru

moschip.ru_4

moschip.ru_6

moschip.ru_9