

PLEASE CHECK WWW.MOLEX.COM FOR LATEST PART INFORMATION

Part Number: [0002092170](#)
Status: **Active**
Overview: [standard_093](#)
Description: 2.36mm (.093") Diameter, Standard .093" Pin and Socket Crimp Terminal, Series 1190, Male, with Tin (Sn) Plated Brass Contact, 14-18 AWG, Large Insulation Crimp, Reel

Documents:

[Drawing \(PDF\)](#) [RoHS Certificate of Compliance \(PDF\)](#)

General

Product Family	Crimp Terminals
Series	42138
Crimp Quality Equipment	Yes
Overview	standard_093
Product Name	Standard .093"

Physical

Gender	Male
Material - Metal	Brass
Material - Plating Mating	Tin
Material - Plating Termination	Tin
Packaging Type	Reel
Plating min: Mating (µin)	20
Plating min: Mating (µm)	0.50
Plating min: Termination (µin)	20
Plating min: Termination (µm)	0.50
Termination Interface: Style	Crimp or Compression
Wire Insulation Diameter	4.57mm (.180") max.
Wire Size AWG	14, 16, 18
Wire Size mm ²	N/A

Material Info

Old Part Number	42138-(P901)
-----------------	--------------

Reference - Drawing Numbers

Sales Drawing	SD-42138-*
---------------	------------

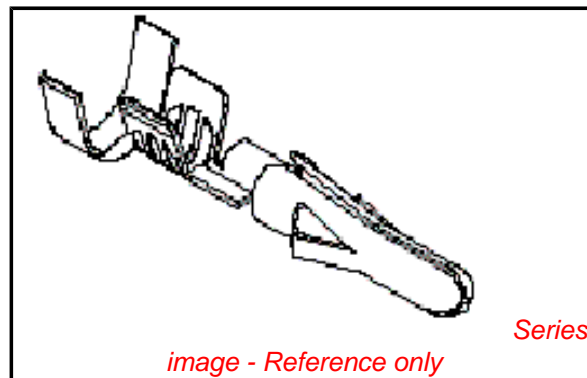

EU RoHS

ELV and RoHS Compliant

REACH SVHC

Contains SVHC: No

Halogen-Free

Status

Halogen-Free

Need more information on product environmental compliance?

Email productcompliance@molex.com
 For a multiple part number RoHS Certificate of Compliance, [click here](#)

Please visit the [Contact Us](#) section for any non-product compliance questions.

China RoHS

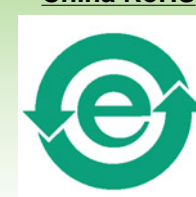

Search Parts in this Series

[42138Series](#)

Use With

[2629](#) , [1619](#) Plug or Receptacle Housing, [1545](#) Plug or Receptacle Housing, [1396](#) Plug or Receptacle Housing, [1490](#) Plug or Receptacle Housing, [1261](#) Plug or Receptacle Housing, [1292](#) Plug or Receptacle Housing, [1360](#) Plug or Receptacle Housing, [1375](#) Plug or Receptacle Housing, [2163](#) Plug or Receptacle Housings

Application Tooling | FAQ

Tooling specifications and manuals are found by selecting the products below. Crimp Height Specifications are then contained in the Application Tooling Specification document.

Global

Description	Product #
Mini-Mac™ Applicator, Double	0638933000

18 AWG Wires, One
Wire Max Insulation
4.32mm (.170") and
One Max Insulation
2.79mm (.110")
Mini-Mac™ 0638933100
Applicator, Insulation
O.D. 2.36mm -
4.57mm (.093"
- .180") and 18 AWG
SPT-3 Wires
Mini-Mac™ 0638933200
Applicator, Double
18 AWG, Two Wire
with Insulation
Diameter of 2.36mm
- 3.56mm (.093"
- .140")
Mini-Mac™ 0638933300
Applicator, Insulation
O.D. 2.36mm -
3.56mm (.093"
- .140") and 18 AWG
SPT-3 Wires
Terminator Die 0011402212

This document was generated on 05/17/2010

PLEASE CHECK WWW.MOLEX.COM FOR LATEST PART INFORMATION

PART NO.	ENG. NO.	
02-09-2170	42138-(P90)I	
02-09-2171	42138-(P90)IL	
02-09-2172	42138-(P90)I	OBSOLETE
02-09-2173	42138-(P90)IL	
	-	
	-	

42138

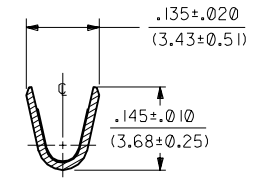
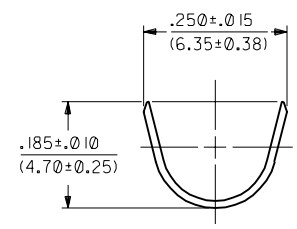
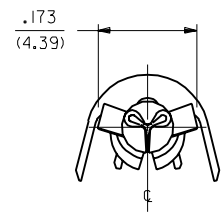

LEGEND

42138-*(****)*

CRIMP STYLE
BLANK="A"
I="B"

FORM
BLANK=CHAIN
L=LOOSE

P=PREPLATE
BLANK=POSTPLATE

FINISH CODE

FINISHES, PER ES-88:
901 HOT TIN DIP .000020/(0.0005) MIN.

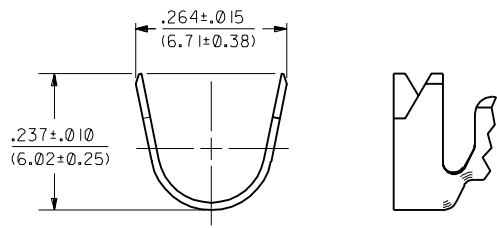

VIEW "A-A"
CRIMP STYLE "B"

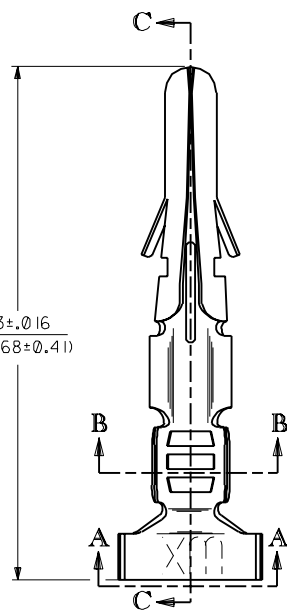

SECTION "C-C"

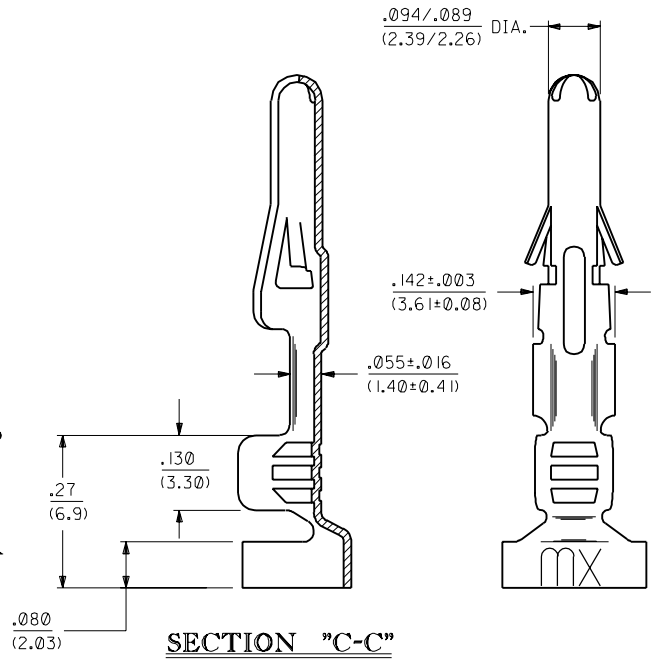

- NOTES:
- TERMINAL FOR USE WITH .093/(2.36) SERIES HOUSINGS AND WILL ACCEPT 14 THRU 18 AWG WIRE.
 - INSULATION CRIMP STYLE "A" ACCEPTS A MAX. INSULATION DIA. OF .180/(4.57). INSULATION CRIMP STYLE "B" IS INTENDED FOR DOUBLE CRIMP OF TWO 18 AWG WIRES; ONE WITH A MAX. INSULATION DIA. OF .170/(4.32), THE OTHER A MAX. INSULATION DIA. OF .110/(2.79).

MATERIAL:
CARTRIDGE BRASS, ALLOY #C26000,
.013/(0.33) THICK, SPRING TEMPER.

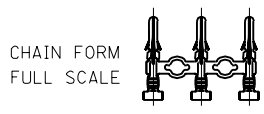

H	OBSOLETE P/N UCR2002-0270 COMERCI 01/10/99
GI	REVISED EOR U3 0507 STAMBAUGH 99-2-9
G	REVISE PER EOR U3 0507 GIC 4/1/93 RW
F	REVISE PER EOR U3 0159 GIC 2/9/93 RW
E	REVISE PER EOR U2 0674 GIC 4/28/92 RW
D	REVISE & REDRAW PER EOR U2 0081 GIC 2/21/92 RW

DIMENSIONS SHOWN (METRIC) INCH		▽ = 0		▽ = 0		REVISE ONLY ON CAD SYSTEM	
UNLESS OTHERWISE SPECIFIED TOLERANCES ANGULAR ± 1/2°		TITLE		CRIMP TERMINAL, MALE		SHEET NO. DATE	
				.093/(2.36) DIA.		1 of 1 2/21/92	
				14-18 AWG W/LARGE INSUL.			
3 PLACE ± .010 ---		INCH METRIC		MOLEX INCORPORATED		U.S.A.	
2 PLACE ± .014 ± 0.25				L15LEJLL 60532		PART NO. DRWG. NO.	
1 PLACE --- ± 0.35				SEE CHART		SD-42138-*	
DRAFT WHERE APPLICABLE MUST REMAIN WITHIN DIMENSIONS				FILE NAME		DIV. SIZE	
				S42138X1		CP C	
DRW. BY GIC		CHK'D. BY RW		THIS DRAWING CONTAINS INFORMATION THAT IS PROPRIETARY TO MOLEX INC. AND SHOULD NOT BE USED WITHOUT WRITTEN PERMISSION.			
APP'D. BY RS		SCALE 6 : 1					

42138

Данный компонент на территории Российской Федерации

Вы можете приобрести в компании MosChip.

Для оперативного оформления запроса Вам необходимо перейти по данной ссылке:

<http://moschip.ru/get-element>

Вы можете разместить у нас заказ для любого Вашего проекта, будь то серийное производство или разработка единичного прибора.

В нашем ассортименте представлены ведущие мировые производители активных и пассивных электронных компонентов.

Нашей специализацией является поставка электронной компонентной базы двойного назначения, продукции таких производителей как XILINX, Intel (ex.ALTERA), Vicor, Microchip, Texas Instruments, Analog Devices, Mini-Circuits, Amphenol, Glenair.

Сотрудничество с глобальными дистрибьюторами электронных компонентов, предоставляет возможность заказывать и получать с международных складов практически любой перечень компонентов в оптимальные для Вас сроки.

На всех этапах разработки и производства наши партнеры могут получить квалифицированную поддержку опытных инженеров.

Система менеджмента качества компании отвечает требованиям в соответствии с ГОСТ Р ИСО 9001, ГОСТ РВ 0015-002 и ЭС РД 009

Офис по работе с юридическими лицами:

105318, г.Москва, ул.Щербаковская д.3, офис 1107, 1118, ДЦ «Щербаковский»

Телефон: +7 495 668-12-70 (многоканальный)

Факс: +7 495 668-12-70 (доб.304)

E-mail: info@moschip.ru

Skype отдела продаж:

moschip.ru

moschip.ru_4

moschip.ru_6

moschip.ru_9