

# HDSM-541x/543x

0.56" (14.22mm)  
Dual digit surface mount LED display



## Data Sheet

### Description

The HDSM-541x/543x is a dual digit display of 0.56" (14.22mm) height. This device utilizes AlInGaP / GaAs chips and has a grey top surface with white segments.

### Features

- 0.56" digit height
- Low current operation
- Excellent characters appearance
- Available in CA and CC
- 500 pieces per reel
- Moisture sensitivity level: Level 3
- RoHS compliant

### Ordering Information

Red	Green	Yellow	Orange	Description
HDSM-541C	HDSM-541H	HDSM-541F	HDSM-541L	Common Anode, Right Hand Decimal
HDSM-543C	HDSM-543H	HDSM-543F	HDSM-543L	Common Cathode, Right Hand Decimal

### Package Dimensions

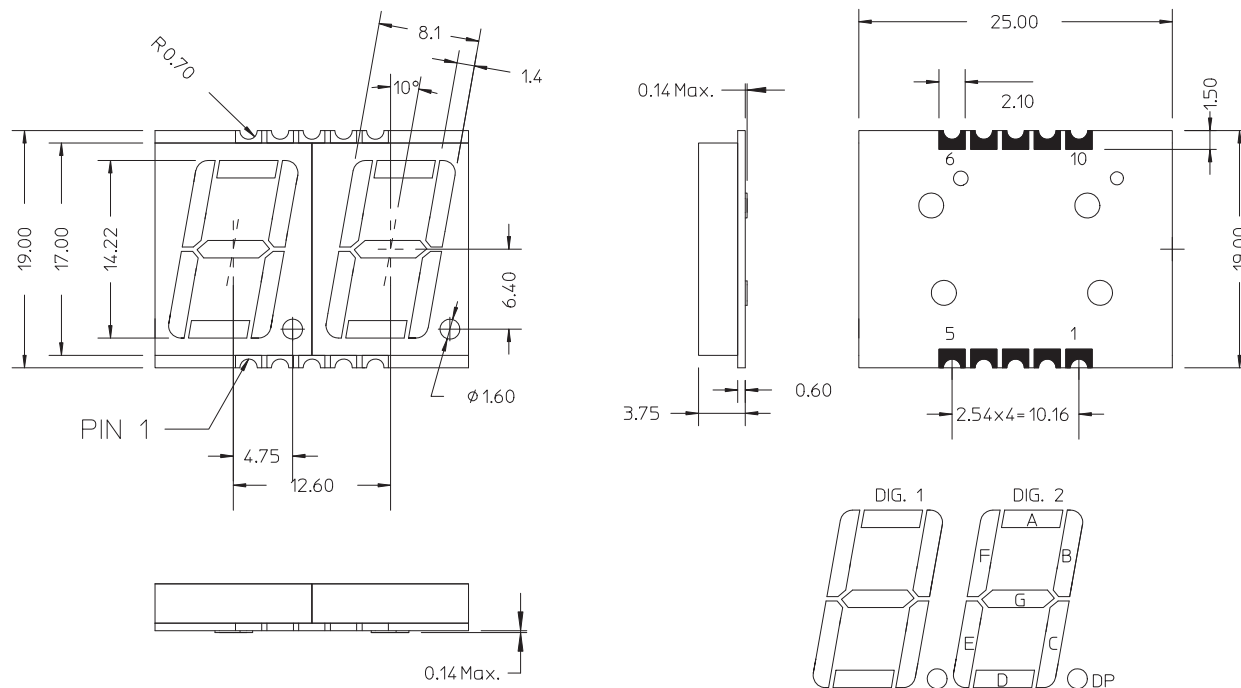

#### Notes:

1. All dimensions are in millimeters (inches).
2. Tolerance are 0.25 mm (0.01") unless otherwise noted.

### Pin Connection (Common Anode)

PIN No	Connection
1	CATHODE G
2	CATHODE DP
3	CATHODE A
4	CATHODE F
5	COMMON ANODE DIG2
6	CATHODE D
7	CATHODE E
8	CATHODE C
9	CATHODE B
10	COMMON ANODE DIG1

### Pin Connection (Common Cathode)

PIN No	Connection
1	ANODE G
2	ANODE DP
3	ANODE A
4	ANODE F
5	COMMON CATHODE DIG2
6	ANODE D
7	ANODE E
8	ANODE C
9	ANODE B
10	COMMON CATHODE DIG 1

### Internal Circuit Diagram (Common Anode)

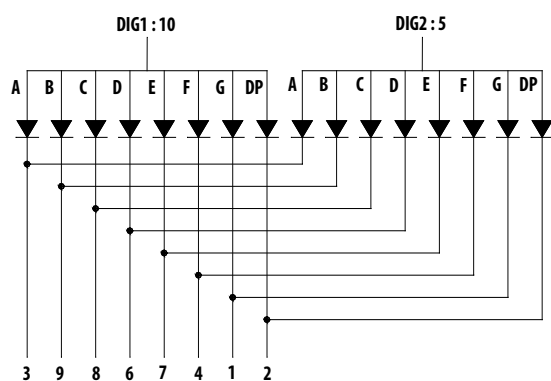

### Internal Circuit Diagram (Common Cathode)

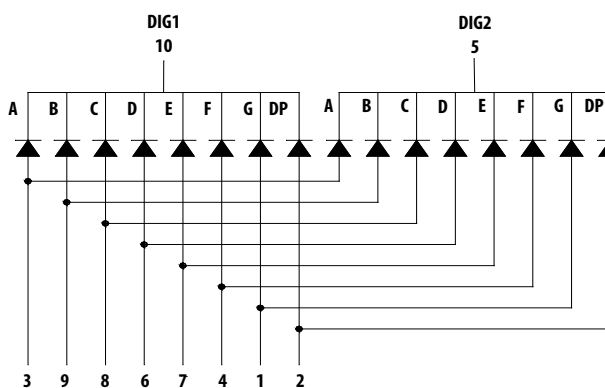

### Absolute Maximum Ratings @ $T_A=25^\circ$

Parameter	Green/Yellow/Red/Orange	Unit
Power Dissipation Per Segment	65	mW
Peak Forward Current Per Segment (1/10 Duty Cycle, .01ms pulse width)	100	mA
Continuous Forward Current Per Segment Derating Linearly From 25°C Per Segment	25	mA
Reverse Voltage Per Segment	5	V
Operating Temperature Range	-40°C to +105°C	
Storage Temperature Range	-40°C to +105°C	

## Electrical / Optical Characteristics @ T<sub>A</sub>=25°C

### Green

Parameters	Symbol	Min	Typ	Max	Unit	Test Condition
Average Luminous Intensity	I <sub>V</sub>	5.4	10.5	-	mcd	I <sub>F</sub> = 10mA
Emissions Wavelength	λ <sub>p</sub> /λ <sub>d</sub>	-	572/571	-	nm	I <sub>F</sub> = 20mA
Spectral Line Half-Width	Δλ	-	20	-	nm	I <sub>F</sub> = 20mA
Forward Voltage, Per Segment	V <sub>F</sub>	-	2.1	2.6	V	I <sub>F</sub> = 20mA
Reverse Current, Per Segment	I <sub>R</sub>	-	-	100	μA	V <sub>R</sub> = 5V
Luminous Intensity Matching Ratio	I <sub>V-M</sub>	-	-	2:1	-	I <sub>F</sub> = 10mA

### Yellow

Parameters	Symbol	Min	Typ	Max	Unit	Test Condition
Average Luminous Intensity	I <sub>V</sub>	8.6	20	-	mcd	I <sub>F</sub> = 10mA
Emissions Wavelength	λ <sub>p</sub> /λ <sub>d</sub>	-	591/589	-	nm	I <sub>F</sub> = 20mA
Spectral Line Half-Width	Δλ	-	15	-	nm	I <sub>F</sub> = 20mA
Forward Voltage, Per Segment	V <sub>F</sub>	-	2.1	2.6	V	I <sub>F</sub> = 20mA
Reverse Current, Per Segment	I <sub>R</sub>	-	-	100	μA	V <sub>R</sub> = 5V
Luminous Intensity Matching Ratio	I <sub>V-M</sub>	-	-	2:1	-	I <sub>F</sub> = 10mA

### Red

Parameters	Symbol	Min	Typ	Max	Unit	Test Condition
Average Luminous Intensity	I <sub>V</sub>	8.6	16.0	-	mcd	I <sub>F</sub> = 10mA
Emissions Wavelength	λ <sub>p</sub> /λ <sub>d</sub>	-	632/624	-	nm	I <sub>F</sub> = 20mA
Spectral Line Half-Width	Δλ	-	20	-	nm	I <sub>F</sub> = 20mA
Forward Voltage, Per Segment	V <sub>F</sub>	-	2.0	2.6	V	I <sub>F</sub> = 20mA
Reverse Current, Per Segment	I <sub>R</sub>	-	-	100	μA	V <sub>R</sub> = 5V
Luminous Intensity Matching Ratio	I <sub>V-M</sub>	-	-	2:1	-	I <sub>F</sub> = 10mA

### Orange

Parameters	Symbol	Min	Typ	Max	Unit	Test Condition
Average Luminous Intensity	I <sub>V</sub>	8.6	19.5	-	mcd	I <sub>F</sub> = 10mA
Emissions Wavelength	λ <sub>p</sub> /λ <sub>d</sub>	-	611/605	-	nm	I <sub>F</sub> = 20mA
Spectral Line Half-Width	Δλ	-	17	-	nm	I <sub>F</sub> = 20mA
Forward Voltage, Per Segment	V <sub>F</sub>	-	2.1	2.6	V	I <sub>F</sub> = 20mA
Reverse Current, Per Segment	I <sub>R</sub>	-	-	100	μA	V <sub>R</sub> = 5V
Luminous Intensity Matching Ratio	I <sub>V-M</sub>	-	-	2:1	-	I <sub>F</sub> = 10mA

Typical Electrical / Optical characteristic curves @  $T_A=25^\circ\text{C}$

Green

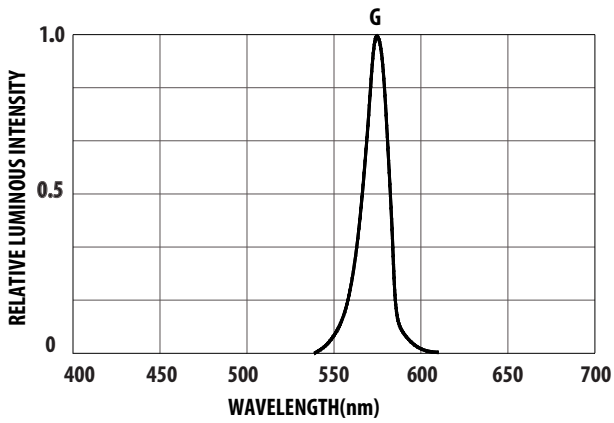

Figure 1. Relative Luminous Intensity vs. Wavelength

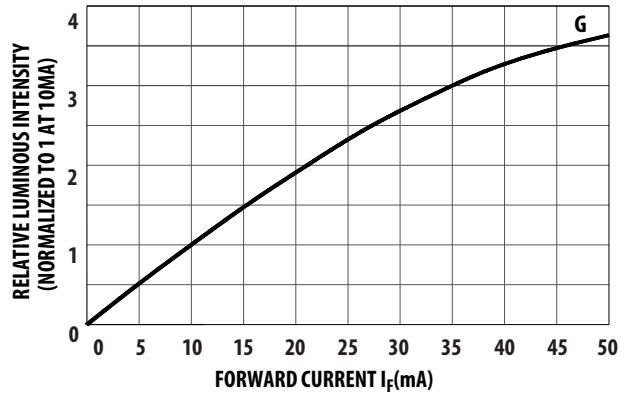

Figure 2. Relative Luminous Intensity vs. Forward Current

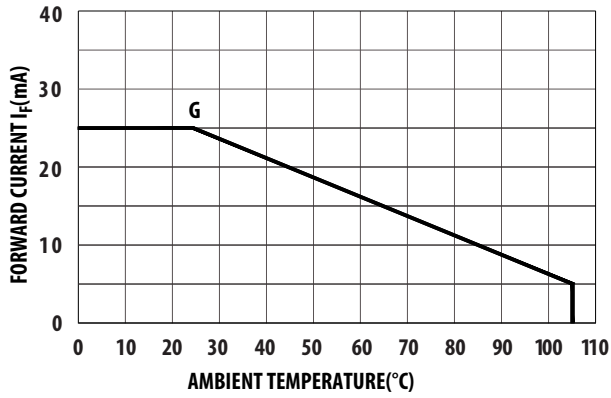

Figure 3. Allowable DC Current vs. Ambient Temperature

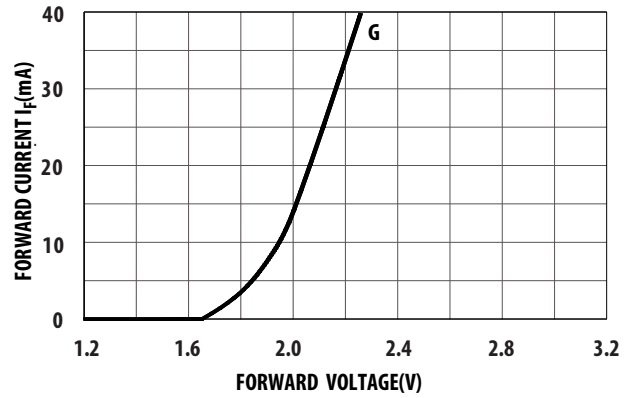

Figure 4. Forward Current vs. Forward Voltage

Yellow

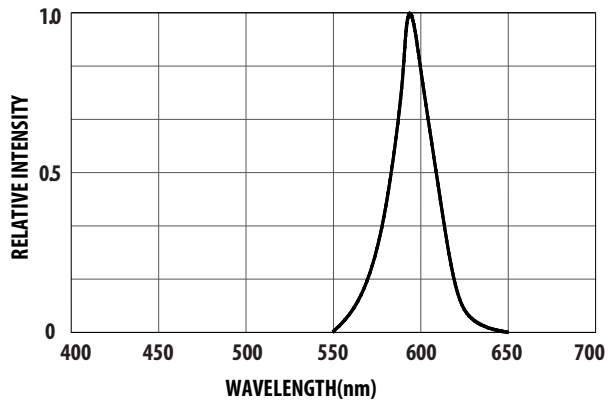

Figure 1. Relative Intensity vs. Wavelength

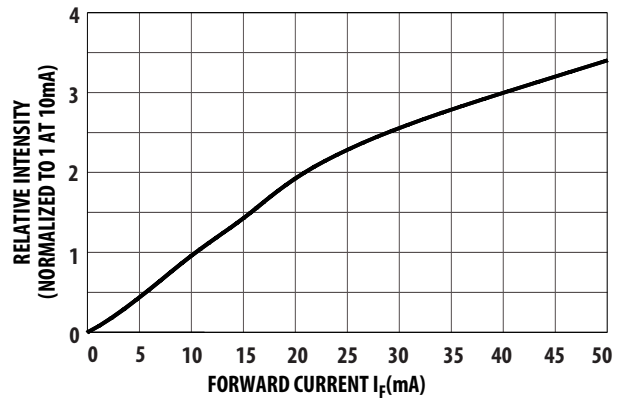

Figure 2. Relative Intensity vs. Forward Current

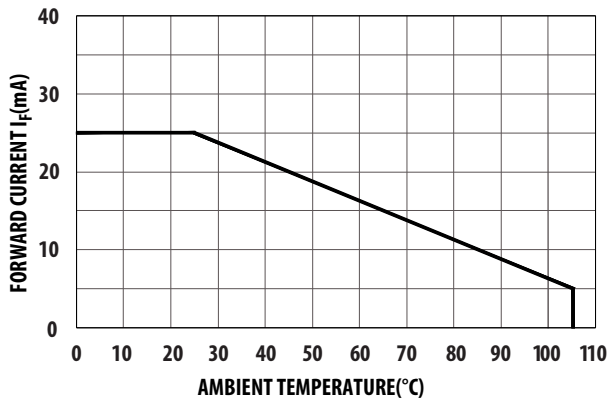

Figure 3. Allowable DC Current vs. Ambient Temperature

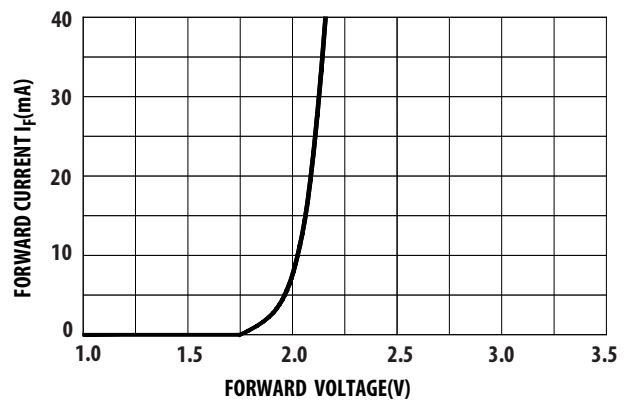

Figure 4. Forward Current vs. Forward Voltage

Red

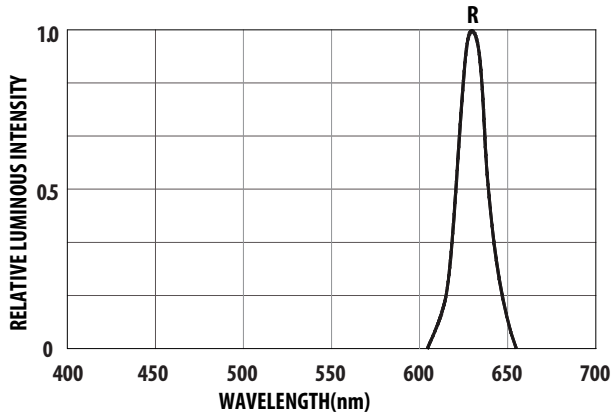

Figure 1. Relative Luminous Intensity vs. Wavelength

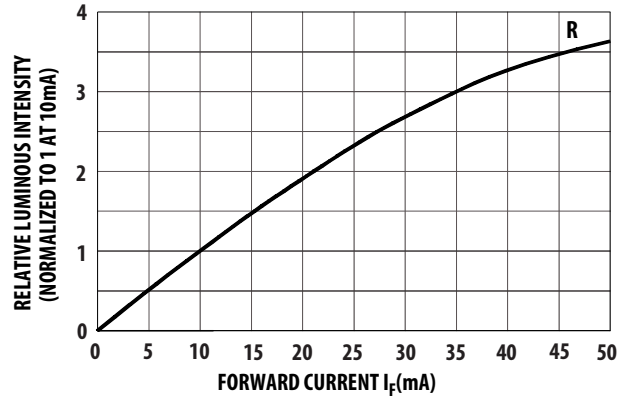

Figure 2. Relative Luminous Intensity vs. Forward Current

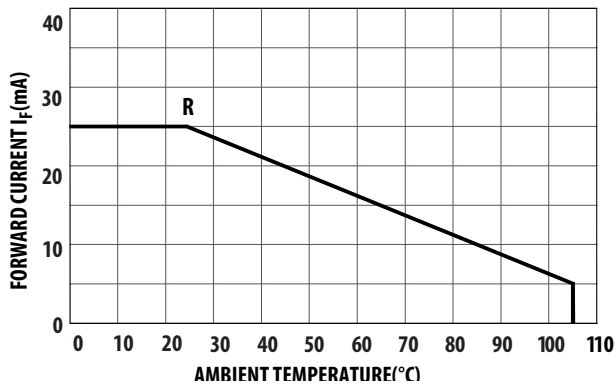

Figure 3. Allowable DC Current vs. Ambient Temperature

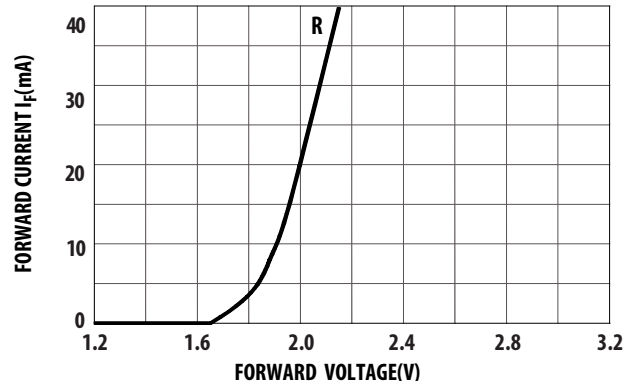

Figure 4. Forward Current vs. Forward Voltage

### Orange

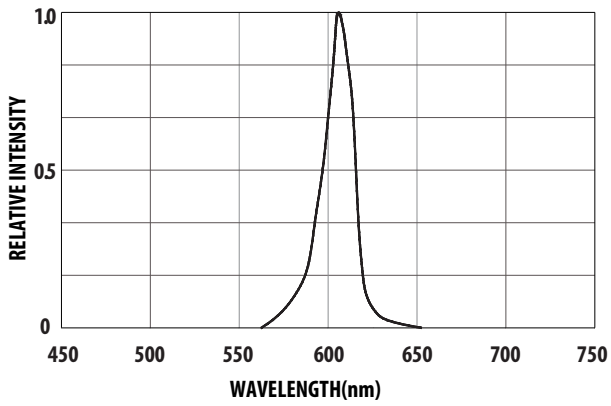

Figure 1. Relative Intensity vs. Wavelength

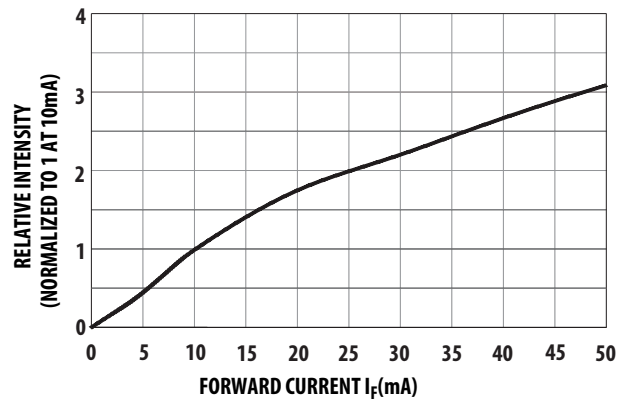

Figure 2. Relative Intensity vs. Forward Current

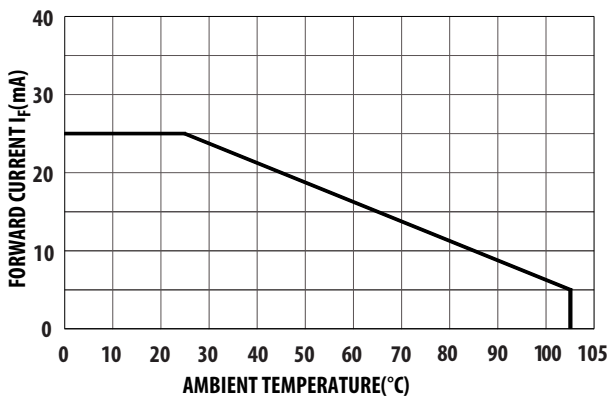

Figure 3. Allowable DC Current vs. Ambient Temperature

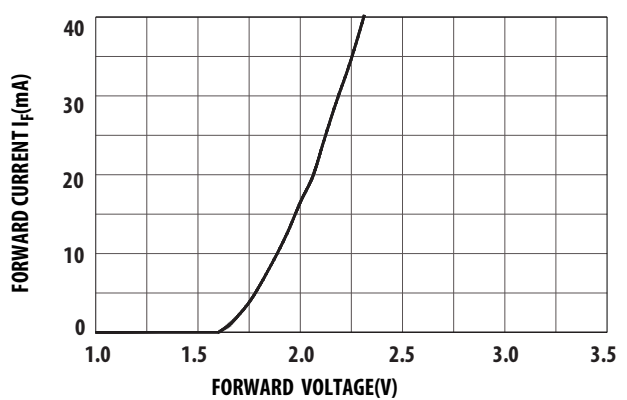

Figure 4. Forward Current vs. Forward Voltage

## Intensity Bin Limits (mcd)

### Green

IV Bin Category	Min.	Max
M	5.401	8.600
N	8.601	13.700
P	13.701	21.800
Q	21.801	34.700

Tolerance: ±15%

### Yellow / Red / Orange

IV Bin Category	Min.	Max
N	8.601	13.700
P	13.701	21.800
Q	21.801	34.700
R	34.701	55.200

Tolerance: ±15%

Note:

- Bin categories are established for classification of products. Products may not be available in all categories. Please contact your Avago representative for information on currently available bins.

## SMT Soldering Profile

### Pb free reflow soldering Profile

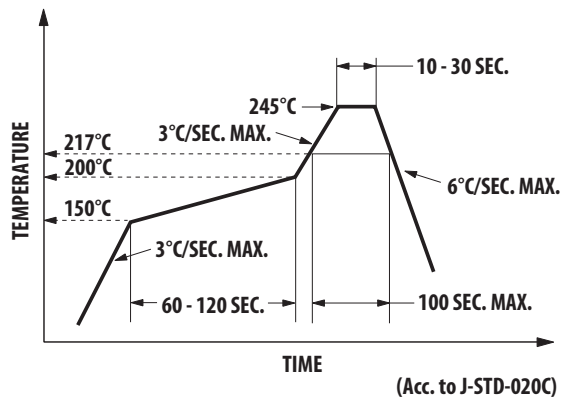

Notes:

- The peak temperature refers to the peak package body temperature.
- Number of reflow process shall be limited to maximum 2 times only. Cooling process to normal temperature is required between first and second soldering process.

## Recommended soldering pattern (unit: mm)

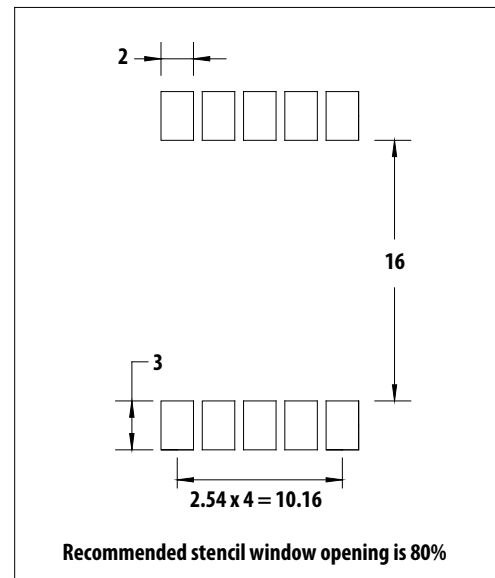



**Tape specification (unit: mm)**

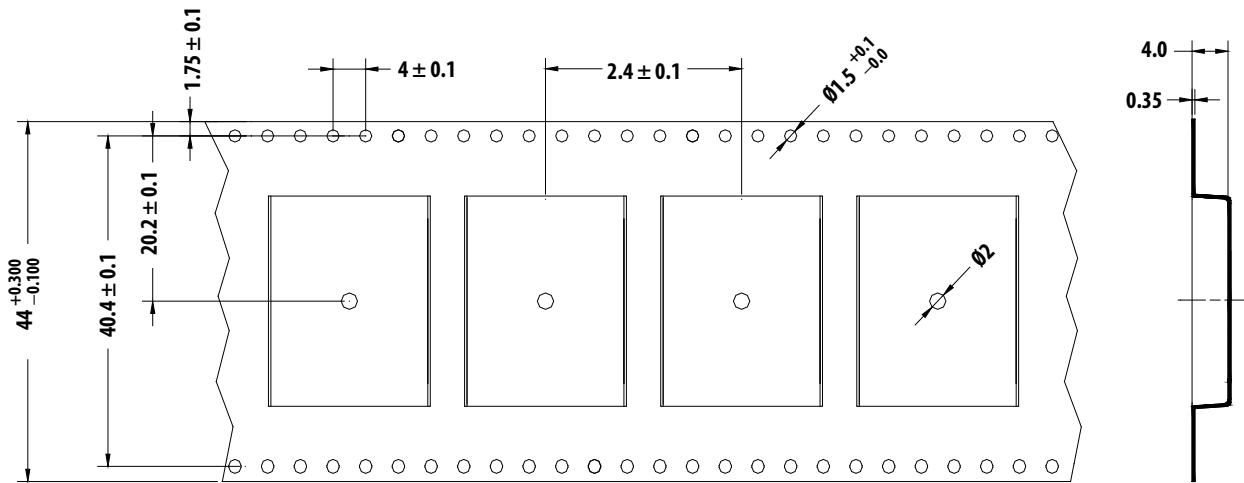

For product information and a complete list of distributors, please go to our web site: [www.avagotech.com](http://www.avagotech.com)

Avago, Avago Technologies, and the A logo are trademarks of Avago Technologies in the United States and other countries. Data subject to change. Copyright © 2005-2011 Avago Technologies. All rights reserved. AV02-0983EN - March 17, 2011



## Данный компонент на территории Российской Федерации

### Вы можете приобрести в компании MosChip.

Для оперативного оформления запроса Вам необходимо перейти по данной ссылке:

<http://moschip.ru/get-element>

Вы можете разместить у нас заказ для любого Вашего проекта, будь то серийное производство или разработка единичного прибора.

В нашем ассортименте представлены ведущие мировые производители активных и пассивных электронных компонентов.

Нашей специализацией является поставка электронной компонентной базы двойного назначения, продукции таких производителей как XILINX, Intel (ex.ALTERA), Vicor, Microchip, Texas Instruments, Analog Devices, Mini-Circuits, Amphenol, Glenair.

Сотрудничество с глобальными дистрибьюторами электронных компонентов, предоставляет возможность заказывать и получать с международных складов практически любой перечень компонентов в оптимальные для Вас сроки.

На всех этапах разработки и производства наши партнеры могут получить квалифицированную поддержку опытных инженеров.

Система менеджмента качества компании отвечает требованиям в соответствии с ГОСТ Р ИСО 9001, ГОСТ РВ 0015-002 и ЭС РД 009

### Офис по работе с юридическими лицами:

105318, г.Москва, ул.Щербаковская д.3, офис 1107, 1118, ДЦ «Щербаковский»

Телефон: +7 495 668-12-70 (многоканальный)

Факс: +7 495 668-12-70 (доб.304)

E-mail: [info@moschip.ru](mailto:info@moschip.ru)

Skype отдела продаж:

moschip.ru

moschip.ru\_4

moschip.ru\_6

moschip.ru\_9