



## SPECIFICATION FOR APPROVAL

---

---

**Customer** \_\_\_\_\_

**Description** DC FAN

**Part No.** \_\_\_\_\_ **Rev.** \_\_\_\_\_

**Delta Model No.** PFB1248UHE-EP **Rev.** 01

**Sample Issue No.** \_\_\_\_\_

**Sample Issue Date.** Aug 01, 2012

PLEASE SEND ONE COPY OF THIS SPECIFICATION  
BACK AFTER YOU SIGNED APPROVAL FOR PRODUCTION  
PRE-ARRANGEMENT.

APPROVED BY : \_\_\_\_\_

DATE : \_\_\_\_\_

**DELTA ELECTRONICS (THAILAND) PUBLIC COMPANY LIMITED.**  
111 MOO 9 WELLGROW INDUSTRIAL ESTATE  
BANGNA-TRAD ROAD, TAMBON BANGWUA,  
AMPHUR BANGPAKONG, CHACHOENSAO 24180 THAILAND  
TEL. +66-(0)-38522455, FAX. +66-(0)-38522477

DELTA ELECTRONICS (THAILAND) PCL.  
 111 MOO 9, WELLGROW INDUSTRIAL ESTATE,  
 BANGNA-TRAD ROAD, BANGWUA, BANGPAKONG,  
 CHACHEONGSAO 24180 THAILAND.

TEL : +66-(0)38-522455  
 FAX : +66-(0)38-522477

**SPECIFICATION FOR APPROVAL**  
 \*\*\*\*\*

Customer:

Description: DC FAN

Customer P/N: REV:

Delta Model NO.: PFB1248UHE-EP

Sample Rev: 01 Issue NO:

Sample Issue Date: Aug 01, 2012 Quantity:

1. SCOPE:

THIS SPECIFICATION DEFINES THE ELECTRICAL AND MECHANICAL  
 CHARACTERISTICS OF THE DC BRUSHLESS AXIAL FLOW FAN.

2. CHARACTERS:

ALL CHARACTERS ARE MEASURED UNDER THE STANDARD  
 ENVIRONMENTAL CONDITION (25°C AND 1 ATM).

| ITEM                                       | DESCRIPTION  |
|--|--|
| RATED VOLTAGE                              | 48 VDC   |
| OPERATION VOLTAGE                          | 30.0 - 60.0 VDC  |
| INPUT CURRENT                              | 0.88 (MAX. 1.06) A   |
| INPUT POWER                                | 42.24 (MAX. 50.88) W   |
| SPEED                                      | 5300 ±10% R.P.M.   |
| MAX. AIR FLOW<br>(AT ZERO STATIC PRESSURE) | 6.900 (MIN. 6.210) M <sup>3</sup> /MIN.<br>243.66 (MIN. 219.29) CFM                |
| MAX.AIR PRESSURE<br>(AT ZERO AIRFLOW)      | 33.315 (MIN. 26.985) mmH <sub>2</sub> O<br>1.311 (MIN. 1.062) inchH <sub>2</sub> O |
| ACOUSTICAL NOISE (AVG.)                    | 66.0 (MAX. 70.0) dB-A  |
| INSULATION TYPE                            | UL: CLASS A  |
| CURRENT ON LABEL                           | 1.20 A   |
| INGRESS PROTECTION                         | IP56(IEC60529 STANDARD)  |
| SALT FOG PROTECTION                        | 30 DAYS (GR-487)   |

(continued)

PART NO:

DELTA MODEL: PFB1248UHE-EP

|                                       |   |
|---------------------------------------|---|
| INSULATION STRENGTH                   | 10 MEG OHM MIN. AT 500 VDC<br>(BETWEEN FRAME AND (+) TERMINAL)  |
| DIELECTRIC STRENGTH                   | 5 mA MAX. AT 500 VAC 50/60 Hz<br>ONE MINUTE, (BETWEEN FRAME AND<br>(+) TERMINAL)  |
| EXTERNAL COVER                        | OPEN TYPE   |
| LIFE EXPECTANCE<br>(AT LABEL VOLTAGE) | L10, 70,000 HOURS<br>AT 40 °C WITH 15 ~ 65 %RH.   |
| ROTATION                              | CLOCKWISE VIEW<br>FROM NAME PLATE SIDE  |
| OVER CURRENT SHUT DOWN                | THE CURRENT WILL SHUT DOWN WHEN<br>LOCKING ROTOR.   |
| LEAD WIRE                             | UL 1061 AWG #22<br>BLACK WIRE NEGATIVE (-)<br>RED WIRE POSITIVE (+)<br>BLUE WIRE FREQUENCY (-FOO)<br>YELLOW WIRE SPEED CONTROL (-PWM) |

- NOTES: 1. ALL READINGS ARE MEASURED AFTER STABLY WARMING UP THROUGH 10 MINUTES.  
2. THE VALUES WRITTEN IN PARENS , ( ), ARE LIMITED SPEC.  
3. ACOUSTICAL NOISE MEASURING CONDITION:

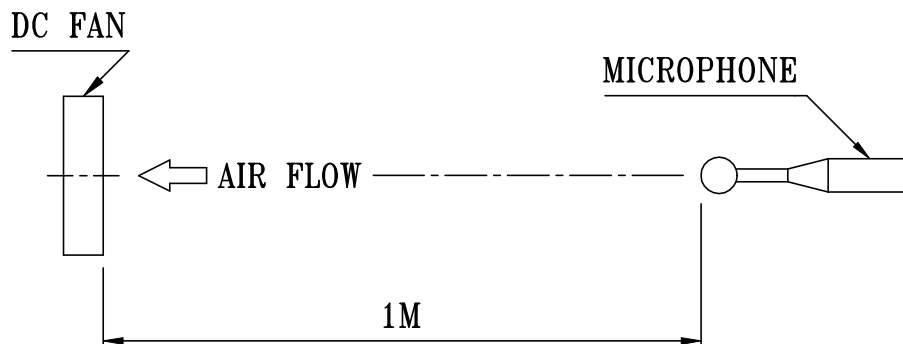

NOISE IS MEASURED AT RATED VOLTAGE IN FREE AIR IN ANECHOIC CHAMBER WITH B & K SOUND LEVEL METER WITH MICROPHONE AT A DISTANCE OF ONE METER FROM THE FAN INTAKE.

-----  
PART NO:  
-----

DELTA MODEL: PFB1248UHE-EP  
-----

3. MECHANICAL:

- 3-1. DIMENSIONS ----- SEE DIMENSIONS DRAWING
- 3-2. FRAME ----- PLASTIC UL: 94V-0
- 3-3. IMPELLER ----- PLASTIC UL: 94V-0
- 3-4. BEARING SYSTEM ----- TWO BALL BEARINGS
- 3-5. WEIGHT ----- 380 GRAMS

4. ENVIRONMENTAL:

- 4-1. OPERATING TEMPERATURE ----- -40 TO +75 DEGREE C
- 4-2. STORAGE TEMPERATURE ----- -40 TO +75 DEGREE C
- 4-3. OPERATING HUMIDITY ----- 5 TO 90 % RH
- 4-4. STORAGE HUMIDITY ----- 5 TO 95 % RH

5. PROTECTION:

5-1. LOCKED ROTOR PROTECTION

PROTECTS MOTOR FROM FIRE IN 96  
HOURS OF LOCKED ROTOR CONDITION AT THE RATED VOLTAGE.

5-2. POLARITY PROTECTION

BE CAPABLE OF WITHSTANDING IF REVERSE CONNECTION FOR POSITIVE  
AND NEGATIVE LEADS.

6. RE OZONE DEPLETING SUBSTANCES:

- 6-1. NO CONTAINING PBBs, PBBOs, CFCs, PBBEs, PBDPEs AND HCFCs.

7. PRODUCTION LOCATION

- 7-1. PRODUCTS WILL BE PRODUCED IN CHINA OR THAILAND OR TAIWAN.

PART NO:

DELTA MODEL: PFB1248UHE-EP

8. P & Q CURVE:

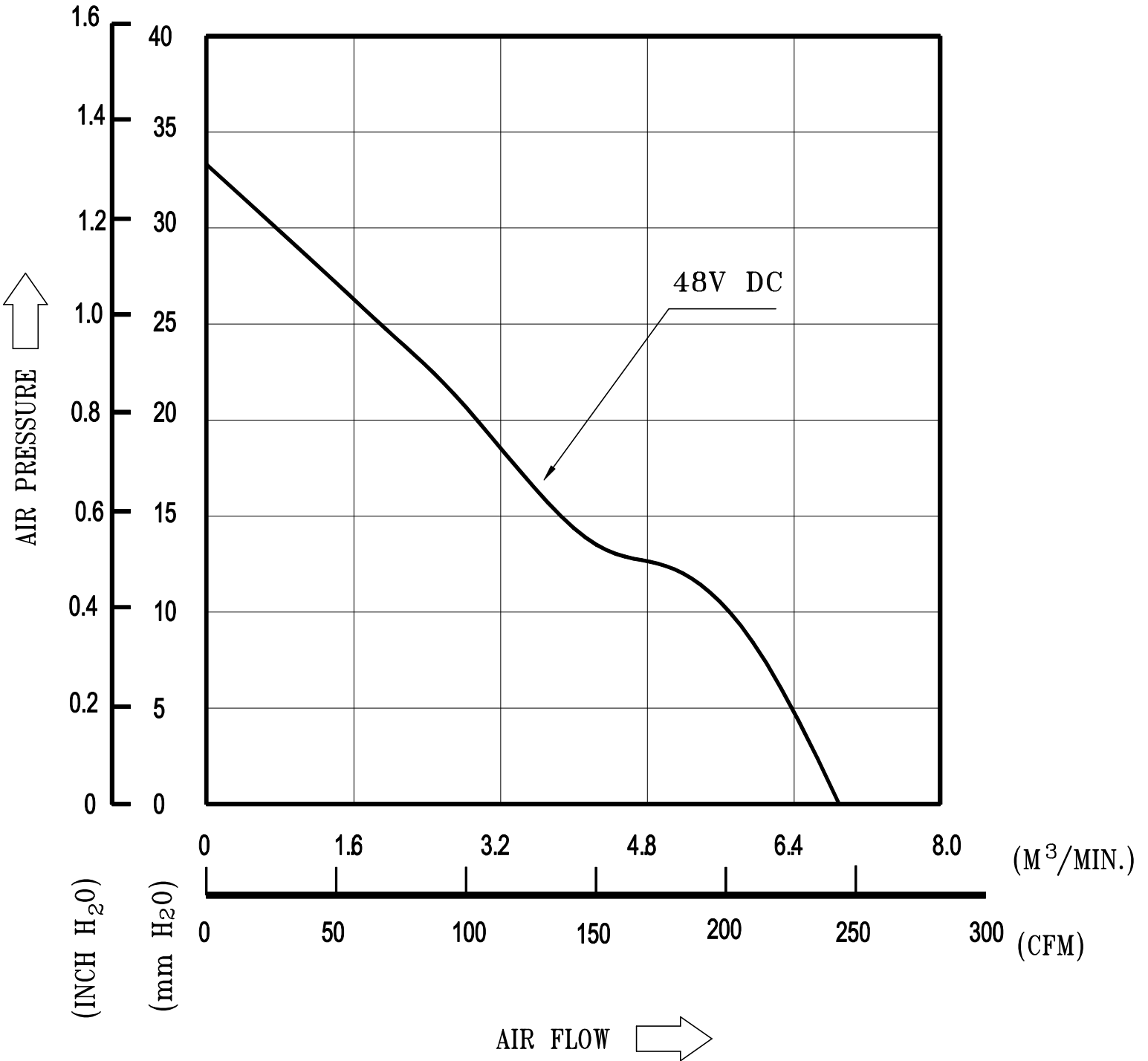

\* TEST CONDITION: INPUT VOLTAGE ----- RATED VOLTAGE  
TEMPERATURE ----- ROOM TEMPERATURE  
HUMIDITY ----- 65%RH

PART NO:

DELTA MODEL: PFB1248UHE-EP

9. DIMENSION DRAWING:

LABEL:

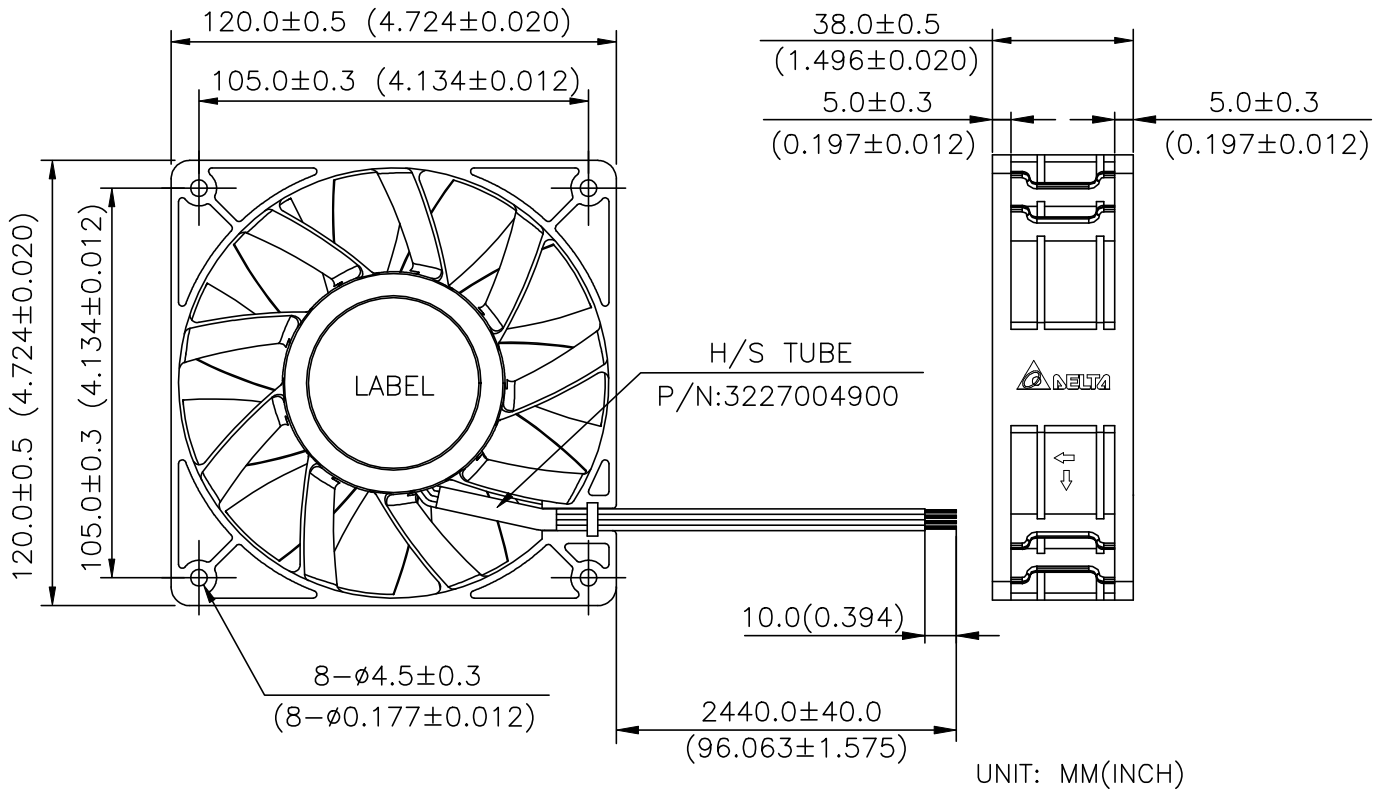
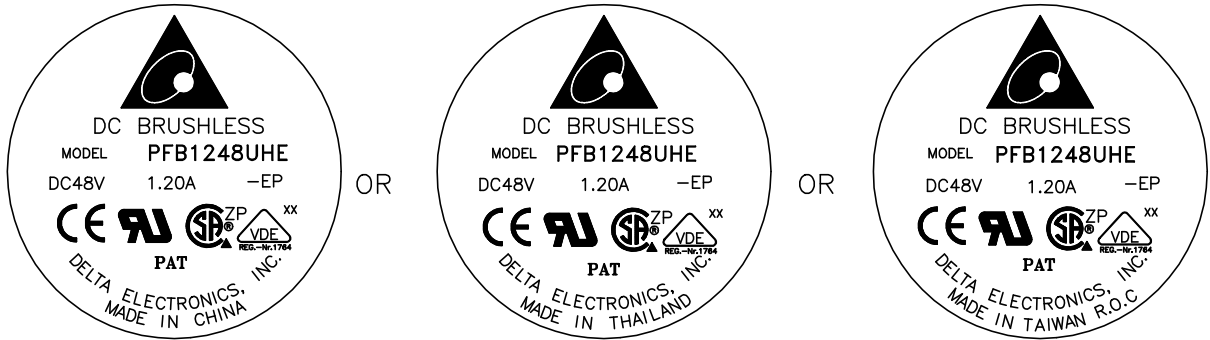

NOTES :

1. H/S TUBE: T3.5\*0.25 125°C 600V BLACK  
DELTA P/N: 3227033600---1PCE (OR EQUIVALENT)
2. LEAD WIRE: UL 1061#22  
BLACK WIRE NEGATIVE (-)  
RED WIRE POSITIVE (+)  
BLUE WIRE FREQUENCY (F00)  
YELLOW WIRE SPEED CONTROL (PWM)
3. THIS PRODUCT IS RoHS COMPLIANT.

PART NO:

DELTA MODEL: PFB1248UHE-EP

10. FREQUENCY GENERATOR (FG) SIGNAL:

1. OUTPUT CIRCUIT - OPEN COLLECTOR MODE:

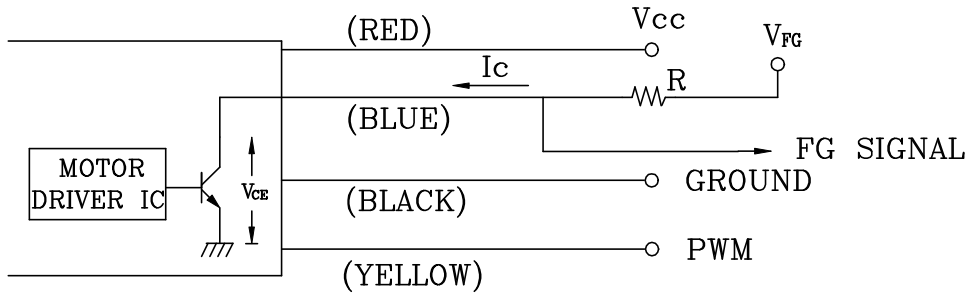

CAUTION:

THE LEAD WIRE OF FG SIGNAL CAN NOT TOUCH  
THE LEAD WIRE OF POSITIVE OR NEGATIVE.

2. SPECIFICATION:

$$V_{CE}(\text{sat}) = 0.5V \text{ MAX.}$$

$$V_{FG} = 60.0V \text{ MAX.}$$

$$I_c = 10\text{mA} \text{ MAX.}$$

$$R \geq V_{FG} / I_c$$

3. FREQUENCY GENERATOR WAVEFORM:

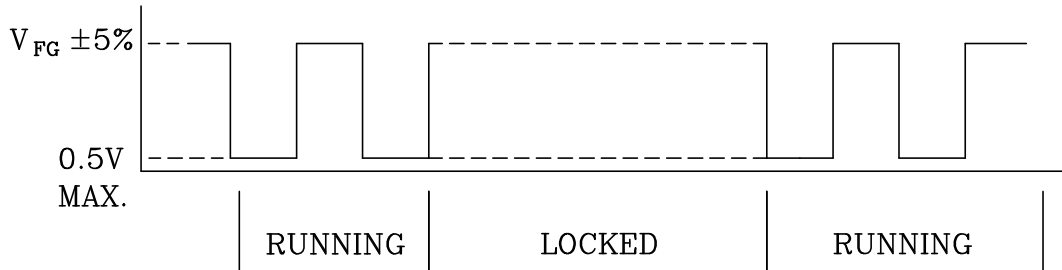

FAN RUNNING FOR 8 POLES

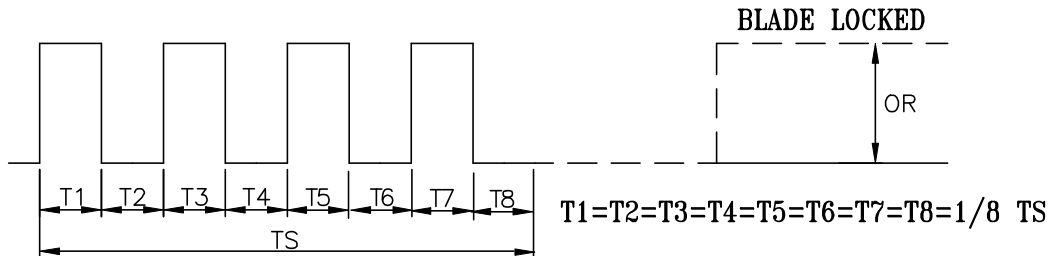

N=R.P.M

TS=60/N(SEC)

\*VOLTAGE LEVEL AFTER BLADE LOCKED

\*8 POLES

-----  
PART NO:  
-----

DELTA MODEL: PFB1248UHE-EP  
-----

11. PWM CONTROL SIGNAL:

SIGNAL VOLTAGE RANGE: 0~15VDC

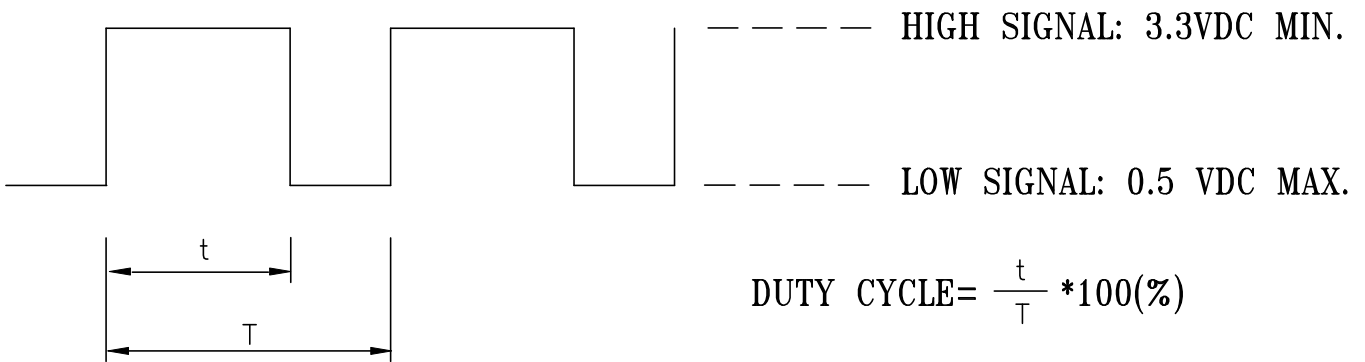

- PWM SIGNAL WITH 5 VDC TTL OR CMOS LEVELS. THE PREFERRED OPERATING POINT FOR THE FAN IS 200 HZ, AND DUTY CYCLE FROM 0% TO 100%.
- AT 100% DUTY CYCLE, THE ROTOR WILL SPIN AT MAXIMUM SPEED.
- AT 0% DUTY CYCLE, THE ROTOR WILL SPIN AT STOP.
- WITH CONTROL SIGNAL LEAD DISCONNECTED, THE FAN WILL SPIN AT MAXIMUM SPEED.

12. SPEED VS PWM CONTROL SIGNAL:

(DC 48V, FREQUENCY: 200 HZ, TEMPERATURE 25C)

| DUTY CYCLE (%) | SPEED R.P.M. (REF.) | CURRENT (A) TYP. |
|----------------|---------------------|------------------|
| 100            | 5300±10%            | 0.88             |
| 50             | 3150±10%            | 0.27             |
| 0              | 0                   | 0.02             |





## ***Application Notice***

- 1. Delta will not guarantee the performance of the products if the application condition falls outside the parameters set forth in the specification.**
- 2. A written request should be submitted to Delta prior to approval if deviation from this specification is required.**
- 3. Please exercise caution when handling fans. Damage may be caused when pressure is applied to the impeller, if the fans are handled by the lead wires, or if the fan was hard-dropped to the production floor.**
- 4. Except as pertains to some special designs, there is no guarantee that the products will be free from any such safety problems or failures as caused by the introduction of powder, droplets of water or encroachment of insect into the hub.**
- 5. The above-mentioned conditions are representative of some unique examples and viewed as the first point of reference prior to all other information.**
- 6. It is very important to establish the correct polarity before connecting the fan to the power source. Positive (+) and Negative (-). Damage may be caused to the fans if connection is with reverse polarity, if there is no foolproof method to protect against such error specifically mentioned in this spec.**
- 7. Delta fans without special protection are not suitable where any corrosive fluids are introduced to their environment.**
- 8. Please ensure all fans are stored according to the storage temperature limits specified. Do not store fans in a high humidity environment. We highly recommend performance testing is conducted before shipping, if the fans have been stored over 6 months.**
- 9. Not all fans are provided with the Lock Rotor Protection feature. If you impair the rotation of the impeller for the fans that do not have this function, the performance of those fans will lead to failure.**
- 10. Please be cautious when mounting the fan. Incorrect mounting of fans may cause excess resonance, vibration and subsequent noise.**
- 11. It is important to consider safety when testing the fans. A suitable fan guard should be fitted to the fan to guard against any potential for personal injury.**
- 12. Except where specifically stated, all tests are carried out at room (ambient) temperature and relative humidity conditions of 25°C, 65% RH. The test value is only for fan performance itself.**
- 13. Be certain to connect an “4.7µF or greater” capacitor to the fan externally when the application calls for using multiple fans in parallel, to avoid any unstable power.**

## Данный компонент на территории Российской Федерации

### Вы можете приобрести в компании MosChip.

Для оперативного оформления запроса Вам необходимо перейти по данной ссылке:

<http://moschip.ru/get-element>

Вы можете разместить у нас заказ для любого Вашего проекта, будь то серийное производство или разработка единичного прибора.

В нашем ассортименте представлены ведущие мировые производители активных и пассивных электронных компонентов.

Нашей специализацией является поставка электронной компонентной базы двойного назначения, продукции таких производителей как XILINX, Intel (ex.ALTERA), Vicor, Microchip, Texas Instruments, Analog Devices, Mini-Circuits, Amphenol, Glenair.

Сотрудничество с глобальными дистрибьюторами электронных компонентов, предоставляет возможность заказывать и получать с международных складов практически любой перечень компонентов в оптимальные для Вас сроки.

На всех этапах разработки и производства наши партнеры могут получить квалифицированную поддержку опытных инженеров.

Система менеджмента качества компании отвечает требованиям в соответствии с ГОСТ Р ИСО 9001, ГОСТ РВ 0015-002 и ЭС РД 009

### Офис по работе с юридическими лицами:

105318, г.Москва, ул.Щербаковская д.3, офис 1107, 1118, ДЦ «Щербаковский»

Телефон: +7 495 668-12-70 (многоканальный)

Факс: +7 495 668-12-70 (доб.304)

E-mail: [info@moschip.ru](mailto:info@moschip.ru)

Skype отдела продаж:

moschip.ru

moschip.ru\_4

moschip.ru\_6

moschip.ru\_9