

■ Package Dimensions :

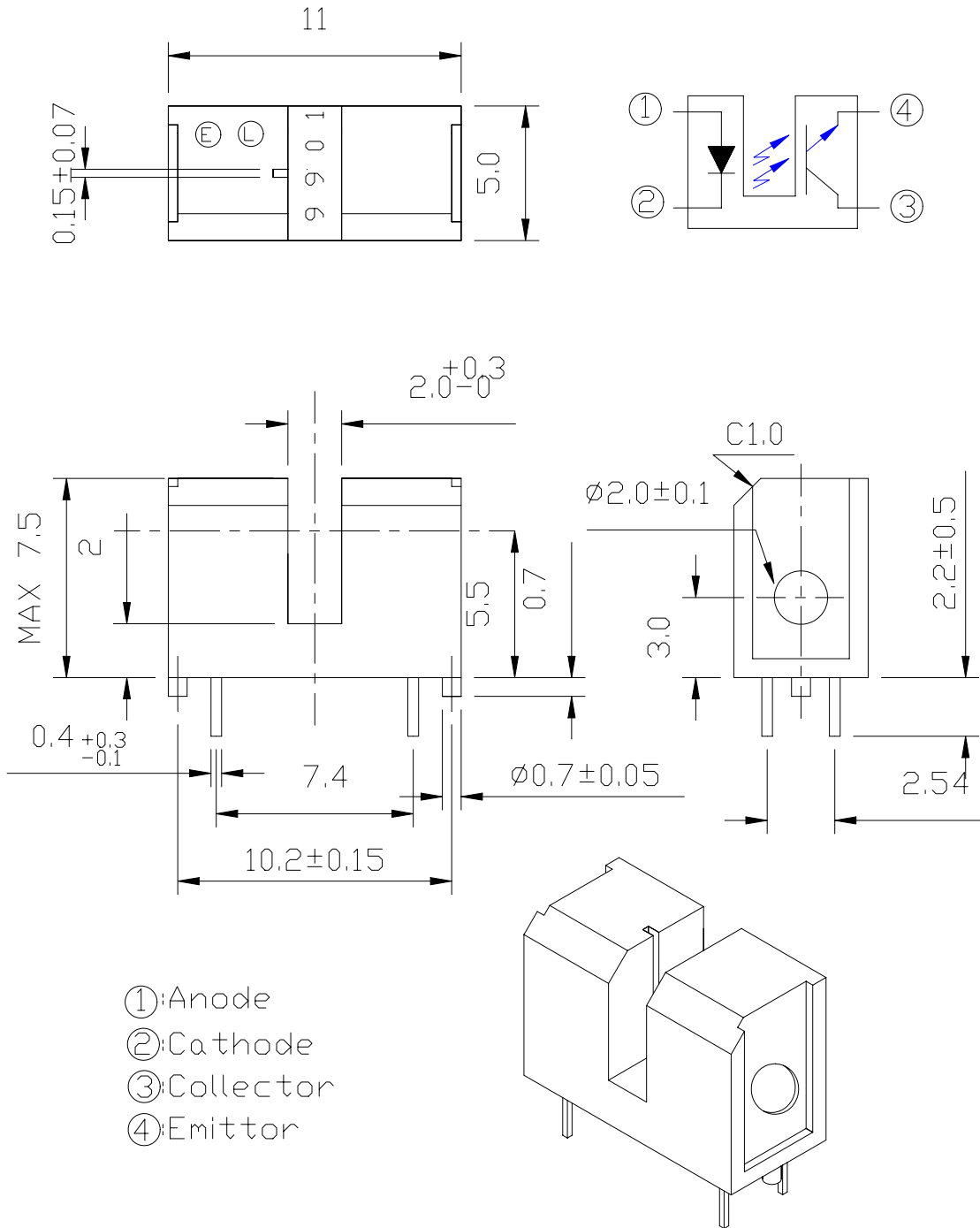

DESIGNER	CHECKER	APPROVED

Office: NO 25, Lane 76, Chung Yang Rd, ,Sec.3
 Tucheng, Taipei 236, Taiwan, R.O.C.
 TEL: 886-2-2267-2000, 2267-9936(22Lines)
 FAX: 886-2-2267-6189

©Notes :

- 1.All dimensions are in millimeter.
- 2.General Tolerance:±0.2mm
- 3.Lead spacing is measured where the lead emerge from the package.
- 4.Above specification may be changed without notice. EVERLIGHT will reserve authority on material change for above specification.
- 5.These specification sheets include materials protected under copyright of EVERLIGHT corporation. Please don't reproduce or cause anyone to reproduce them without EVERLIGHT's consent.
- 6.When using this product , please observe the absolute maximum ratings and the instructions for use outlined in these specification sheets. EVERLIGHT assumes no responsibility for any damage resulting from use of the product which does not comply with the absolute maximum ratings and the instructions included in these specification sheets.

■ Descriptions:

The **ITR9901** (Slot Optical Switch) is a gallium arsenide infrared emitting diode coupled with a silicon photo transistor in a plastic holder. The packaging system is designed to optimizes the mechanical resolution, coupling efficiency, and insulates ambient light. The slot in the holder that provides a means of interrupting the signal with printer, scanner, copier, or other opaque material, switching the output from an " ON" to " OFF" state.

■ Features:

- Wide gap between light emitter and detector(2.0mm)
- High sensing accuracy
- PWB mounting type package
- Pb free
- The product itself will remain within RoHS compliant version.

■ Applications:

- Copier
- Printer
- Facsimile
- Ticket vending machine
- Opto-electronic switch

Absolute Maximum Ratings (Ta=25°C)

Parameter		Symbol	Ratings	Unit
Input	Power Dissipation at(or below) 25°C Free Air Temperature	Pd	75	mW
	Reverse Voltage	V _R	6	V
	Forward Current	I _F	50	mA
	Peak Forward Current Pulse width ≤100 μs, Duty cycle=1%	I _{FP}	1	A
Output	Collector Power Dissipation	P _C	75	mW
	Collector Current	I _C	20	mA
	Collector-Emitter Voltage	V _{CEO}	35	V
	Emitter-Collector Voltage	V _{ECO}	6	V
Operating Temperature		Topr	-25~+85	°C
Storage Temperature		Tstg	-40~+85	°C
Lead Soldering Temperature (1/16 inch from body for 5 seconds)		Tsol	260	°C

Electro-Optical Characteristics (Ta=25°C)

Parameter		Symbol	Min.	Typ.	Max.	Unit	Condition
Input	Forward Voltage	V _F	-	1.2	1.5	V	I _F =20mA
	Reverse Current	I _R	-	-	10	μA	V _R =3V
	Peak Wavelength	λ _p	-	940	-	nm	I _F =20mA
Output	Collector Dark Current	I _{CEO}	-	1	100	nA	V _{CE} =20V Ee=0mW/cm ²
Transfer Characteristic	C-E Saturation Voltage	V _{CE(sat)}	-	-	0.4	V	I _C =0.25mA I _F =40mA
	Collector Current	I _{C(ON)}	0.4	-	-	mA	V _{CE} =5V I _F =20mA
	Rise time	t _r	-	-	80	μsec	V _{CE} =4.4V
	Fall time	t _f	-	-	800	μsec	I _C =13mA R _L =47KΩ

■ Typical Characteristics For IR

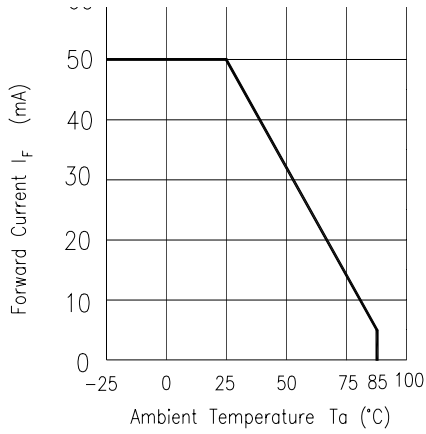

Fig. 3 Peak Emission Wavelength vs. Ambient Temperature

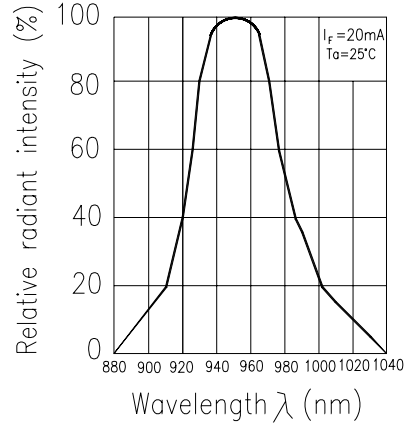
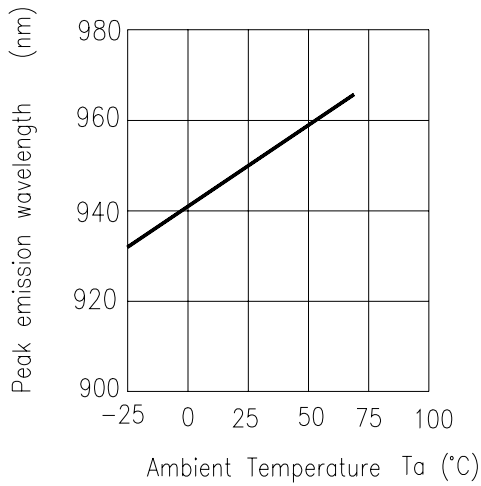

Fig. 5 Forward Voltage vs. Ambient Temperature

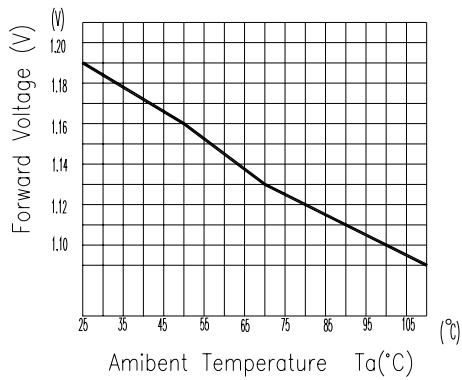

Fig. 6 Relative Radiant Intensity vs. Angular Displacement

Typical Characteristics For PT

Fig.1 Collector Power Dissipation vs. Ambient Temperature

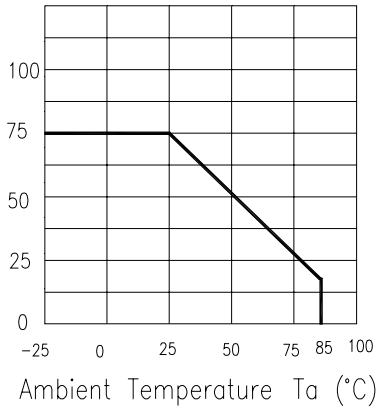

Fig.2 Collector Dark Current vs. Ambient Temperature

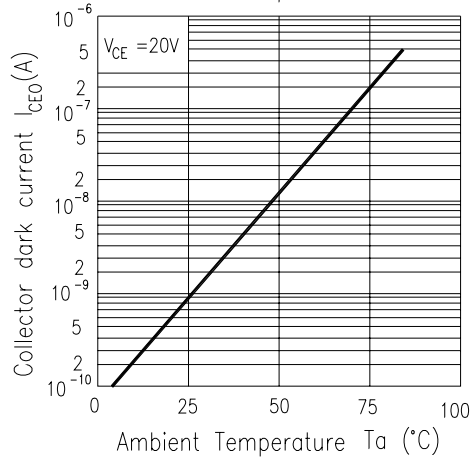

Fig.3 Spectral Sensitivity

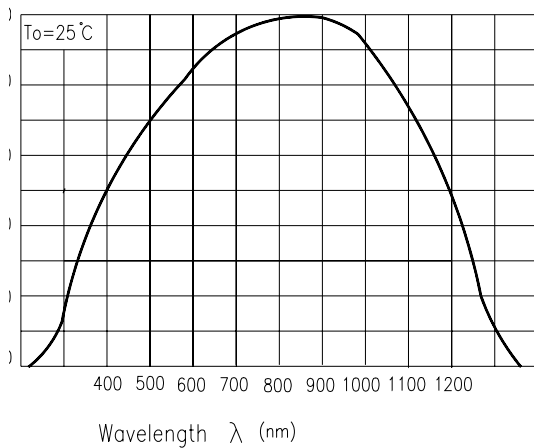
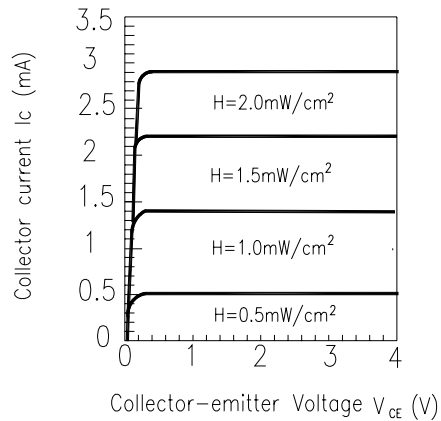

Fig.4 Collector Current vs. Collector-emitter Voltage



Typical Characteristics For ITR

Fig.1 Relative Collector Current vs. Shield Distance(1)

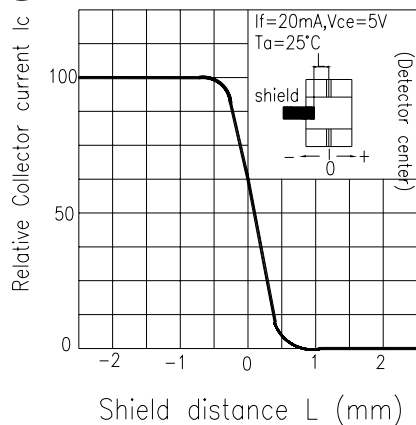
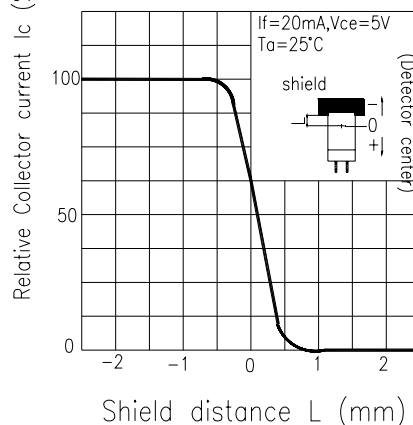

Fig.2 Relative Collector Current vs. Shield Distance(2)



■ Reliability test item and condition

The reliability of products shall be satisfied with item listed below:

Parameter	Purpose & Condition	Failure Judgement Criteria	Samples(n) Defective(c)
Temperature Cycle	Evaluates product's ability to withstand exposure to high temperature, low temperature, and temperature variation between two limit temperature. Standard test Condition: $\begin{array}{cccc} 85^{\circ}\text{C} & \sim & 25^{\circ}\text{C} & \sim & -55^{\circ}\text{C} & \sim & 25^{\circ}\text{C} \\ \downarrow & & \downarrow & & \downarrow & & \downarrow \\ 30\text{min} & & 5\text{min} & & 30\text{min} & & 5\text{min} \end{array}$ 50 cycle	$I_R \geq U \times 2$ $I_{c(on)} \leq L \times 0.8$ $V_F \geq U \times 1.2$ U : Upper specification limit L : Lower specification limit	n =22 , c=0
Thermal Shock	Evaluates product's ability to withstand rapid temperature change Standard test Condition: $85^{\circ}\text{C} \sim -55^{\circ}\text{C}$ $\begin{array}{cc} 5\text{min} & 5\text{min} \end{array}$ 50cycle		n =22 , c=0
High Temperature Storage	Evaluates product's ability to withstand prolonged storage at high temperature Standard test Condition: Temperature : 100°C Time : 1000hrs		n =22 , c=0
Low Temperature Storage	Evaluates product's ability to withstand prolonged storage at low temperature Standard test Condition: Temperature : -55°C Time : 1000hrs		n =22 , c=0

Parameter	Purpose & Condition	Failure Judgement Criteria	Samples(n) Defective(c)
Operating Life Test	Evaluates product's endurance to prolonged electrical or temperature stresses. Standard test Condition: $V_{CE}=5V$ $I_F=20mA$ Time : 1000hrs	$I_R \geq U \times 2$ $I_{c(on)} \leq L \times 0.8$ $V_F \geq U \times 1.2$ U : Upper specification limit	n =22 , c=0
High Temperature High Humidity	Evaluates product's ability to withstand prolonged storage at high temperature and high humidity. Standard test Condition: Temperature: 85°C Relative humidity:85% Time : 1000hrs	L : Lower specification limit	n =22 , c=0
Soldering Heat	Evaluates product's ability to withstand soldering heat Standard test conditions Solder temperature : 260±5°C Solder time : 10 seconds		n =22 , c=0

■Supplements

1.Parts

(1) Chip

Type	Material	Peak Wavelength
IR	GaAs	940 nm
PT	Silicon	860 nm

(2)Material

Type	Lead frame	Wire	Part Package	Holder
Material	SPCC	Gold	Epoxy	Noryl

■ Packing Specifications

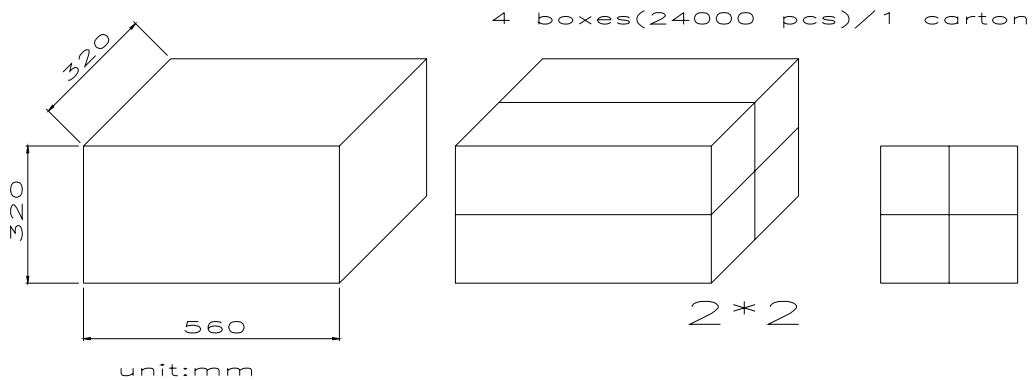
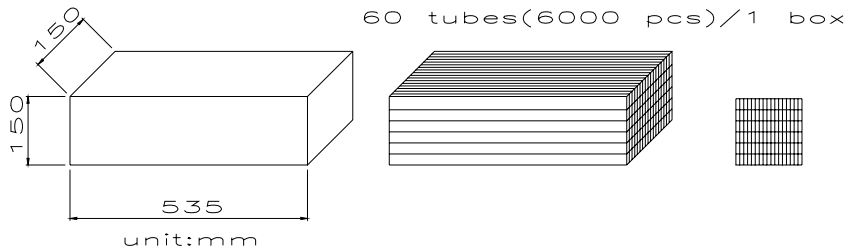
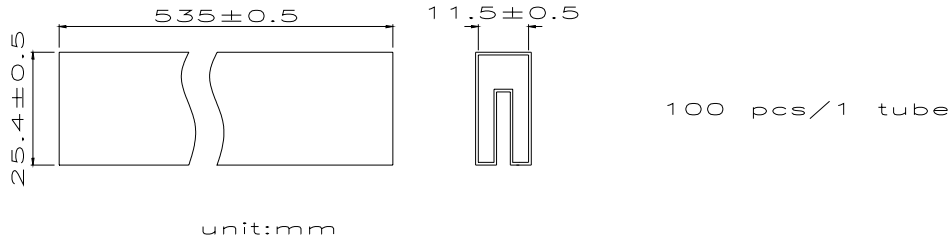

■ Label Specifications

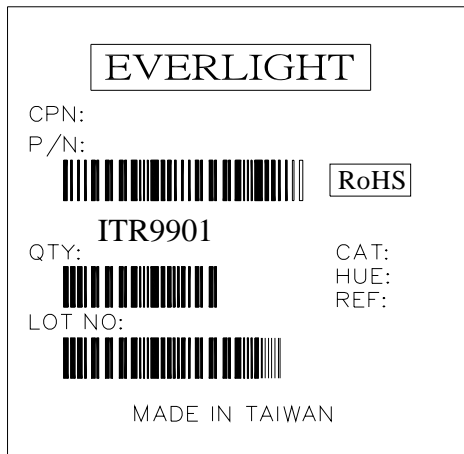

CPN : Customer's Product Number

P/N : Product Number

QTY : Packing Quantity

CAT : Ranks

HUE : Peak Wavelength

REF : Reference

LOT NO : Lot Number

MADE IN TAIWAN : Production Place

Данный компонент на территории Российской Федерации

Вы можете приобрести в компании MosChip.

Для оперативного оформления запроса Вам необходимо перейти по данной ссылке:

<http://moschip.ru/get-element>

Вы можете разместить у нас заказ для любого Вашего проекта, будь то серийное производство или разработка единичного прибора.

В нашем ассортименте представлены ведущие мировые производители активных и пассивных электронных компонентов.

Нашей специализацией является поставка электронной компонентной базы двойного назначения, продукции таких производителей как XILINX, Intel (ex.ALTERA), Vicor, Microchip, Texas Instruments, Analog Devices, Mini-Circuits, Amphenol, Glenair.

Сотрудничество с глобальными дистрибьюторами электронных компонентов, предоставляет возможность заказывать и получать с международных складов практически любой перечень компонентов в оптимальные для Вас сроки.

На всех этапах разработки и производства наши партнеры могут получить квалифицированную поддержку опытных инженеров.

Система менеджмента качества компании отвечает требованиям в соответствии с ГОСТ Р ИСО 9001, ГОСТ РВ 0015-002 и ЭС РД 009

Офис по работе с юридическими лицами:

105318, г.Москва, ул.Щербаковская д.3, офис 1107, 1118, ДЦ «Щербаковский»

Телефон: +7 495 668-12-70 (многоканальный)

Факс: +7 495 668-12-70 (доб.304)

E-mail: info@moschip.ru

Skype отдела продаж:

moschip.ru

moschip.ru_4

moschip.ru_6

moschip.ru_9