



# RF LDMOS Wideband Integrated Power Amplifiers

The A2I09VD030N wideband integrated circuit is designed with on-chip matching that makes it usable from 575 to 960 MHz. This multi-stage structure is rated for 48 to 55 V operation and covers all typical cellular base station modulation formats.

## 900 MHz

- Typical Single-Carrier W-CDMA Performance:  $V_{DD} = 48$  Vdc,  $I_{DQ1(A+B)} = 46$  mA,  $I_{DQ2(A+B)} = 154$  mA,  $P_{out} = 4$  W Avg., Input Signal PAR = 9.9 dB @ 0.01% Probability on CCDF.

Frequency	$G_{ps}$ (dB)	PAE (%)	ACPR (dBc)
920 MHz	34.4	19.9	-45.0
940 MHz	34.5	20.0	-44.6
960 MHz	34.3	19.8	-44.3

## 700 MHz

- Typical Single-Carrier W-CDMA Performance:  $V_{DD} = 48$  Vdc,  $I_{DQ1(A+B)} = 50$  mA,  $I_{DQ2(A+B)} = 150$  mA,  $P_{out} = 4$  W Avg., Input Signal PAR = 9.9 dB @ 0.01% Probability on CCDF.

Frequency	$G_{ps}$ (dB)	PAE (%)	ACPR (dBc)
728 MHz	30.9	19.6	-44.7
748 MHz	31.1	19.5	-45.5
768 MHz	31.2	19.3	-46.2

## Features

- On-chip matching (50 ohm input, DC blocked)
- Integrated quiescent current temperature compensation with enable/disable function (1)
- Designed for digital predistortion error correction systems
- Optimized for Doherty applications

**A2I09VD030NR1**  
**A2I09VD030GNR1**

**575–960 MHz, 4 W AVG., 48 V**  
**AIRFAST RF LDMOS WIDEBAND**  
**INTEGRATED POWER AMPLIFIERS**

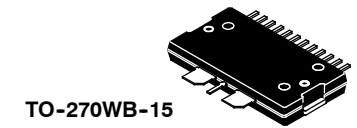

**TO-270WB-15**  
**PLASTIC**  
**A2I09VD030NR1**

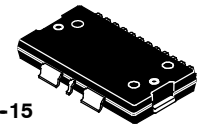

**TO-270WBG-15**  
**PLASTIC**  
**A2I09VD030GNR1**

1. Refer to AN1977, *Quiescent Current Thermal Tracking Circuit in the RF Integrated Circuit Family*, and to AN1987, *Quiescent Current Control for the RF Integrated Circuit Device Family*. Go to <http://www.nxp.com/RF> and search for AN1977 or AN1987.

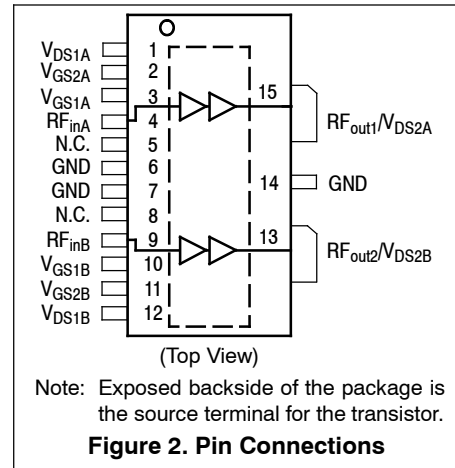
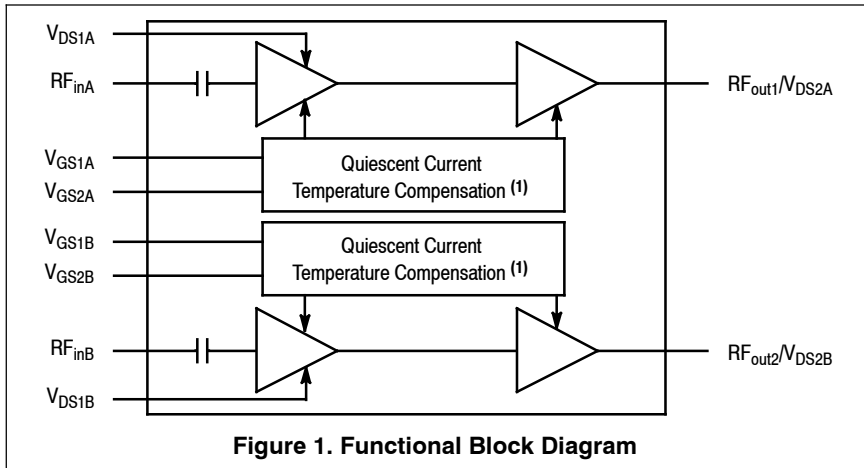

**Table 1. Maximum Ratings**

Rating	Symbol	Value	Unit
Drain-Source Voltage	$V_{DSS}$	-0.5, +105	Vdc
Gate-Source Voltage	$V_{GS}$	-0.5, +10	Vdc
Operating Voltage	$V_{DD}$	55, +0	Vdc
Storage Temperature Range	$T_{stg}$	-65 to +150	°C
Case Operating Temperature Range	$T_C$	-40 to +150	°C
Operating Junction Temperature Range (2,3)	$T_J$	-40 to +225	°C
Input Power	$P_{in}$	20	dBm

**Table 2. Thermal Characteristics**

Characteristic	Symbol	Value (3,4)	Unit
Thermal Resistance, Junction to Case Case Temperature 73°C, 4 W Avg., W-CDMA, 940 MHz Stage 1, 48 Vdc, $I_{DQ1(A+B)}$ 46 mA Stage 2, 48 Vdc, $I_{DQ2(A+B)}$ 154 mA	$R_{\theta JC}$	6.7 2.8	°C/W

**Table 3. ESD Protection Characteristics**

Test Methodology	Class
Human Body Model (per JESD22-A114)	1B
Charge Device Model (per JESD22-C101)	C0B

**Table 4. Moisture Sensitivity Level**

Test Methodology	Rating	Package Peak Temperature	Unit
Per JESD22-A113, IPC/JEDEC J-STD-020	3	260	°C

1. Refer to AN1977, *Quiescent Current Thermal Tracking Circuit in the RF Integrated Circuit Family*, and to AN1987, *Quiescent Current Control for the RF Integrated Circuit Device Family*. Go to <http://www.nxp.com/RF> and search for AN1977 or AN1987.
2. Continuous use at maximum temperature will affect MTTF.
3. MTTF calculator available at <http://www.nxp.com/RF/calculators>.
4. Refer to AN1955, *Thermal Measurement Methodology of RF Power Amplifiers*. Go to <http://www.nxp.com/RF> and search for AN1955.

**Table 5. Electrical Characteristics** ( $T_A = 25^\circ\text{C}$  unless otherwise noted)

Characteristic	Symbol	Min	Typ	Max	Unit
<b>Stage 1 - Off Characteristics</b> <sup>(1)</sup>					
Zero Gate Voltage Drain Leakage Current ( $V_{DS} = 105\text{ Vdc}$ , $V_{GS} = 0\text{ Vdc}$ )	$I_{DSS}$	—	—	10	$\mu\text{Adc}$
Zero Gate Voltage Drain Leakage Current ( $V_{DS} = 55\text{ Vdc}$ , $V_{GS} = 0\text{ Vdc}$ )	$I_{DSS}$	—	—	1	$\mu\text{Adc}$
Gate-Source Leakage Current ( $V_{GS} = 1.5\text{ Vdc}$ , $V_{DS} = 0\text{ Vdc}$ )	$I_{GSS}$	—	—	1	$\mu\text{Adc}$
<b>Stage 1 - On Characteristics</b>					
Gate Threshold Voltage <sup>(1)</sup> ( $V_{DS} = 10\text{ Vdc}$ , $I_D = 1.5\ \mu\text{Adc}$ )	$V_{GS(th)}$	1.3	1.8	2.3	Vdc
Fixture Gate Quiescent Voltage ( $V_{DD} = 48\text{ Vdc}$ , $I_{DQ1(A+B)} = 46\text{ mAdc}$ , Measured in Functional Test)	$V_{GS(Q)}$	4.8	5.5	6.4	Vdc
<b>Stage 2 - Off Characteristics</b> <sup>(1)</sup>					
Zero Gate Voltage Drain Leakage Current ( $V_{DS} = 105\text{ Vdc}$ , $V_{GS} = 0\text{ Vdc}$ )	$I_{DSS}$	—	—	10	$\mu\text{Adc}$
Zero Gate Voltage Drain Leakage Current ( $V_{DS} = 55\text{ Vdc}$ , $V_{GS} = 0\text{ Vdc}$ )	$I_{DSS}$	—	—	1	$\mu\text{Adc}$
Gate-Source Leakage Current ( $V_{GS} = 1.5\text{ Vdc}$ , $V_{DS} = 0\text{ Vdc}$ )	$I_{GSS}$	—	—	1	$\mu\text{Adc}$
<b>Stage 2 - On Characteristics</b>					
Gate Threshold Voltage <sup>(1)</sup> ( $V_{DS} = 10\text{ Vdc}$ , $I_D = 7\ \mu\text{Adc}$ )	$V_{GS(th)}$	1.3	1.8	2.3	Vdc
Fixture Gate Quiescent Voltage ( $V_{DD} = 48\text{ Vdc}$ , $I_{DQ2(A+B)} = 154\text{ mAdc}$ , Measured in Functional Test)	$V_{GS(Q)}$	4.0	5.0	5.6	Vdc
Drain-Source On-Voltage <sup>(1)</sup> ( $V_{GS} = 10\text{ Vdc}$ , $I_D = 100\text{ mAdc}$ )	$V_{DS(on)}$	0.1	0.8	1.5	Vdc

1. Each side of device measured separately.

(continued)

**Table 5. Electrical Characteristics** ( $T_A = 25^\circ\text{C}$  unless otherwise noted) (continued)

Characteristic	Symbol	Min	Typ	Max	Unit
<b>Functional Tests</b> (1,2) (In NXP Test Fixture, 50 ohm system) $V_{DD} = 48\text{ Vdc}$ , $I_{DQ1(A+B)} = 46\text{ mA}$ , $I_{DQ2(A+B)} = 154\text{ mA}$ , $P_{out} = 4\text{ W Avg.}$ , $f = 960\text{ MHz}$ , Single-Carrier W-CDMA, IQ Magnitude Clipping, Input Signal PAR = 9.9 dB @ 0.01% Probability on CCDF. ACPR measured in 3.84 MHz Channel Bandwidth @ $\pm 5\text{ MHz}$ Offset.					
Power Gain	$G_{ps}$	32.0	34.3	35.0	dB
Power Added Efficiency	PAE	18.5	19.8	—	%
Output Peak-to-Average Ratio @ 0.01% Probability on CCDF	PAR	8.9	9.2	—	dB
Adjacent Channel Power Ratio	ACPR	—	-44.3	-41.7	dBc

**Load Mismatch** (In NXP Test Fixture, 50 ohm system)  $I_{DQ1(A+B)} = 46\text{ mA}$ ,  $I_{DQ2(A+B)} = 154\text{ mA}$ ,  $f = 940\text{ MHz}$

VSWR 10:1 at 55 Vdc, 44.5 W CW Output Power (3 dB Input Overdrive from 33 W CW Rated Power)	No Device Degradation
--	-----------------------

**Typical Performance** (In NXP Test Fixture, 50 ohm system)  $V_{DD} = 48\text{ Vdc}$ ,  $I_{DQ1(A+B)} = 46\text{ mA}$ ,  $I_{DQ2(A+B)} = 154\text{ mA}$ , 920–960 MHz Bandwidth

$P_{out}$ @ 1 dB Compression Point, CW	P1dB	—	33.3	—	W
$P_{out}$ @ 3 dB Compression Point (3)	P3dB	—	40.5	—	W
AM/PM (Maximum value measured at the P3dB compression point across the 920–960 MHz frequency range.)	$\Phi$	—	-10	—	°
VBW Resonance Point (IMD Third Order Intermodulation Inflection Point)	$VBW_{res}$	—	130	—	MHz
Quiescent Current Accuracy over Temperature (4) with 2 k $\Omega$ Gate Feed Resistors (-30 to 85°C) Stage 1 with 2 k $\Omega$ Gate Feed Resistors (-30 to 85°C) Stage 2	$\Delta I_{QT}$	—	2 8	—	%
Gain Flatness in 40 MHz Bandwidth @ $P_{out} = 4\text{ W Avg.}$	$G_F$	—	0.2	—	dB
Gain Variation over Temperature (-30°C to +85°C)	$\Delta G$	—	0.026	—	dB/°C
Output Power Variation over Temperature (-30°C to +85°C)	$\Delta P1dB$	—	0.006	—	dB/°C

**Table 6. Ordering Information**

Device	Tape and Reel Information	Package
A2I09VD030NR1	R1 Suffix = 500 Units, 44 mm Tape Width, 13-inch Reel	TO-270WB-15
A2I09VD030GNR1		TO-270WBG-15

- Part internally input matched.
- Measurements made with device in straight lead configuration before any lead forming operation is applied. Lead forming is used for gull wing (GN) parts.
- $P3dB = P_{avg} + 7.0\text{ dB}$  where  $P_{avg}$  is the average output power measured using an unclipped W-CDMA single-carrier input signal where output PAR is compressed to 7.0 dB @ 0.01% probability on CCDF.
- Refer to AN1977, *Quiescent Current Thermal Tracking Circuit in the RF Integrated Circuit Family*, and to AN1987, *Quiescent Current Control for the RF Integrated Circuit Device Family*. Go to <http://www.nxp.com/RF> and search for AN1977 or AN1987.

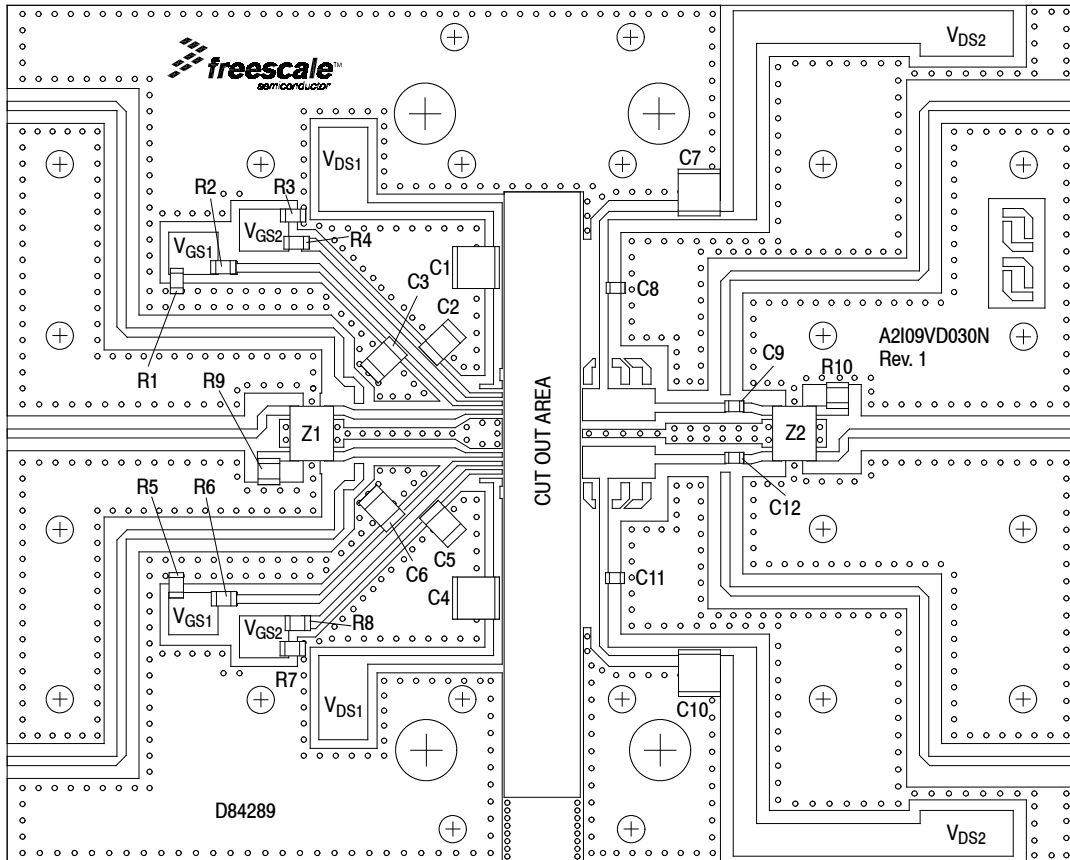

Figure 3. A2109VD030NR1 Test Circuit Component Layout – 920–960 MHz

Table 7. A2109VD030NR1 Test Circuit Component Designations and Values – 920–960 MHz

Part	Description	Part Number	Manufacturer
C1, C4, C7, C10	10 $\mu$ F Chip Capacitor	C5750X7S2A106M	TDK
C2, C3, C5, C6	3.3 $\mu$ F Chip Capacitor	C4532X7R1H335K	TDK
C8, C9, C11, C12	47 pF Chip Capacitor	ATC600F470JT250XT	ATC
R1, R3, R5, R7	51 k $\Omega$ , 1/4 W Chip Resistor	CRCW120651K0JNEA	Vishay
R2, R4, R6, R8	1.5 k $\Omega$ , 1/4 W Chip Resistor	CRCW12061K50FKEA	Vishay
R9, R10	50 $\Omega$ , 4 W Chip Resistor	C10A50Z4	Anaren
Z1, Z2	800–1000 MHz, 90°, 3 dB Hybrid Coupler	X3C09P1–03S	Anaren
PCB	Rogers RO4350B, 0.020", $\epsilon_r = 3.66$	D84289	MTL

### TYPICAL CHARACTERISTICS – 920-960 MHz

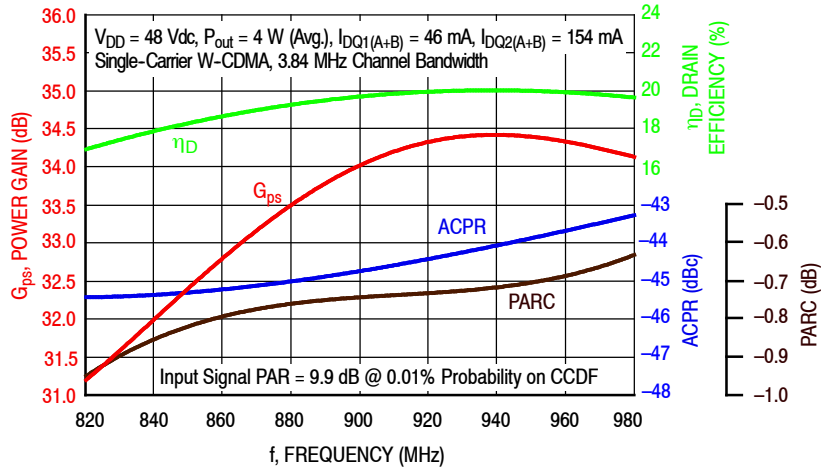

Figure 4. Single-Carrier Output Peak-to-Average Ratio Compression (PARC) Broadband Performance @  $P_{out} = 4$  Watts Avg.

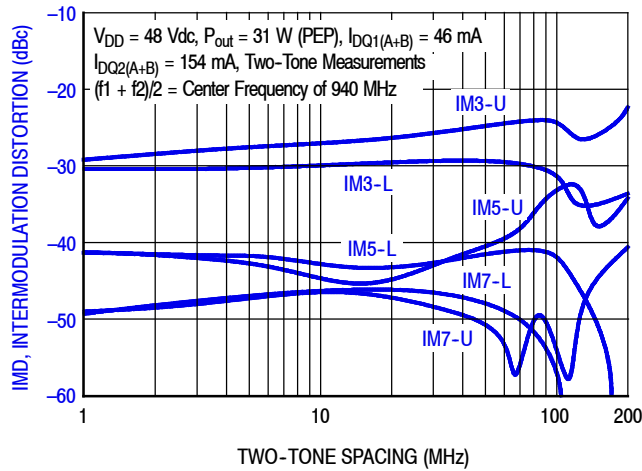

Figure 5. Intermodulation Distortion Products versus Two-Tone Spacing

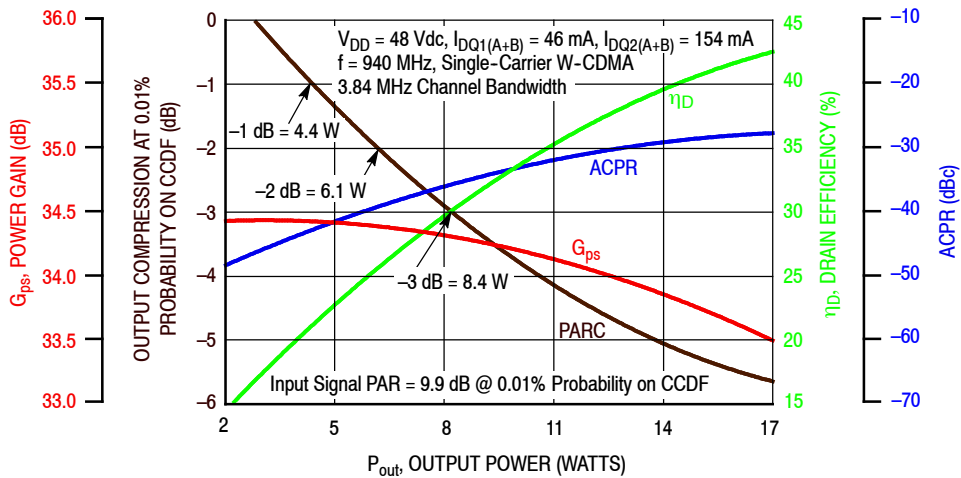
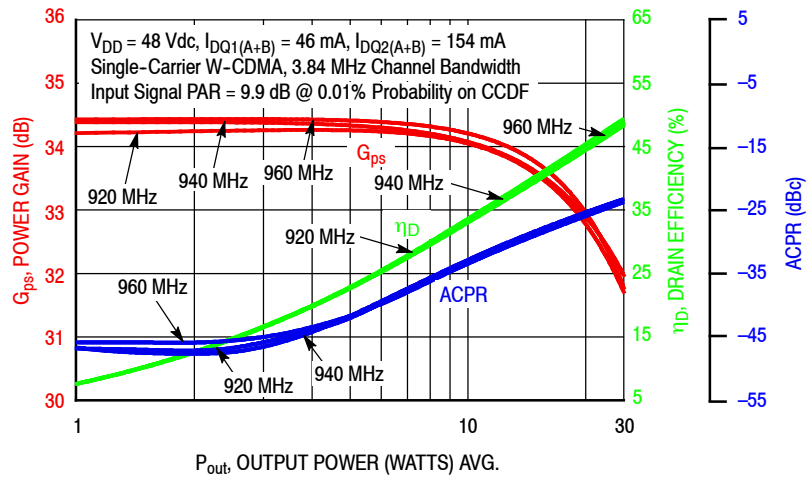
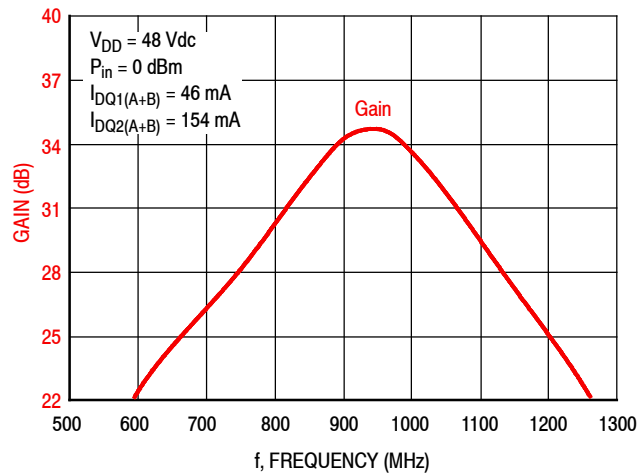

Figure 6. Output Peak-to-Average Ratio Compression (PARC) versus Output Power

### TYPICAL CHARACTERISTICS – 920-960 MHz



**Figure 7. Single-Carrier W-CDMA Power Gain, Drain Efficiency and ACPR versus Output Power**



**Figure 8. Broadband Frequency Response**

**Table 8. Load Pull Performance — Maximum Power Tuning**

$V_{DD} = 48 \text{ Vdc}$ ,  $I_{DQ1} = 23 \text{ mA}$ ,  $I_{DQ2} = 77 \text{ mA}$ , Pulsed CW, 10  $\mu\text{sec(ON)}$ , 10% Duty Cycle

f (MHz)	$Z_{\text{source}} (\Omega)$	$Z_{\text{in}} (\Omega)$	Max Output Power					
			P1dB					
			$Z_{\text{load}}^{(1)} (\Omega)$	Gain (dB)	(dBm)	(W)	$\eta_D$ (%)	AM/PM (°)
920	42.0 – j3.99	47.6 + j4.36	19.0 + j17.4	33.0	43.5	22	62.4	–4
940	51.7 – j4.27	55.1 + j9.85	20.8 + j17.3	33.0	43.6	23	62.5	–4
960	61.3 – j9.97	64.0 + j11.2	21.8 + j17.6	32.9	43.8	24	63.6	–4

f (MHz)	$Z_{\text{source}} (\Omega)$	$Z_{\text{in}} (\Omega)$	Max Output Power					
			P3dB					
			$Z_{\text{load}}^{(2)} (\Omega)$	Gain (dB)	(dBm)	(W)	$\eta_D$ (%)	AM/PM (°)
920	42.0 – j3.99	48.7 + j4.46	21.2 + j15.9	30.8	44.4	27	64.2	–4
940	51.7 – j4.27	55.9 + j9.75	22.3 + j15.8	30.7	44.4	27	63.6	–4
960	61.3 – j9.97	64.5 + j10.9	22.3 + j16.1	30.7	44.5	28	63.9	–4

(1) Load impedance for optimum P1dB power.

(2) Load impedance for optimum P3dB power.

$Z_{\text{source}}$  = Measured impedance presented to the input of the device at the package reference plane.

$Z_{\text{in}}$  = Impedance as measured from gate contact to ground.

$Z_{\text{load}}$  = Measured impedance presented to the output of the device at the package reference plane.

**Note: Measurement made on a per side basis.**

**Table 9. Load Pull Performance — Maximum Efficiency Tuning**

$V_{DD} = 48 \text{ Vdc}$ ,  $I_{DQ1} = 23 \text{ mA}$ ,  $I_{DQ2} = 77 \text{ mA}$ , Pulsed CW, 10  $\mu\text{sec(ON)}$ , 10% Duty Cycle

f (MHz)	$Z_{\text{source}} (\Omega)$	$Z_{\text{in}} (\Omega)$	Max Drain Efficiency					
			P1dB					
			$Z_{\text{load}}^{(1)} (\Omega)$	Gain (dB)	(dBm)	(W)	$\eta_D$ (%)	AM/PM (°)
920	42.0 – j3.99	47.5 + j11.4	13.9 + j32.8	36.0	40.9	12	72.4	–6
940	51.7 – j4.27	56.3 + j13.8	17.7 + j28.9	34.9	42.3	17	71.3	–5
960	61.3 – j9.97	66.7 + j14.6	17.7 + j30.1	34.8	42.2	17	71.7	–6

f (MHz)	$Z_{\text{source}} (\Omega)$	$Z_{\text{in}} (\Omega)$	Max Drain Efficiency					
			P3dB					
			$Z_{\text{load}}^{(2)} (\Omega)$	Gain (dB)	(dBm)	(W)	$\eta_D$ (%)	AM/PM (°)
920	42.0 – j3.99	50.2 + j11.4	13.4 + j33.0	34.1	41.6	15	73.9	–10
940	51.7 – j4.27	57.5 + j13.6	17.4 + j29.2	32.9	42.9	20	72.3	–7
960	61.3 – j9.97	68.0 + j14.3	17.0 + j30.8	32.9	42.7	19	72.4	–7

(1) Load impedance for optimum P1dB efficiency.

(2) Load impedance for optimum P3dB efficiency.

$Z_{\text{source}}$  = Measured impedance presented to the input of the device at the package reference plane.

$Z_{\text{in}}$  = Impedance as measured from gate contact to ground.

$Z_{\text{load}}$  = Measured impedance presented to the output of the device at the package reference plane.

**Note: Measurement made on a per side basis.**

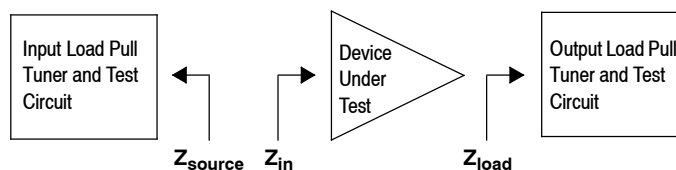



## P1dB – TYPICAL LOAD PULL CONTOURS — 940 MHz

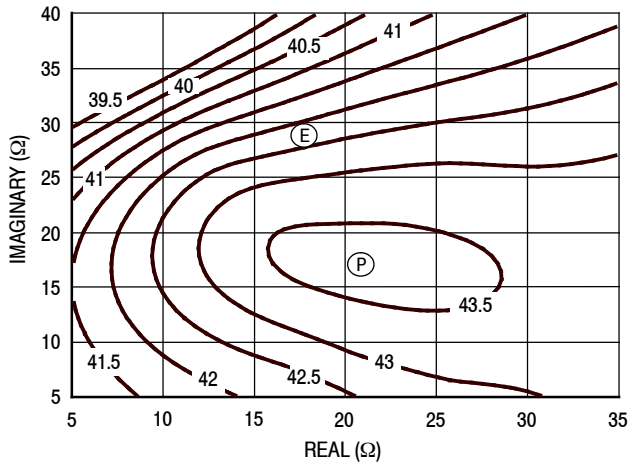

Figure 9. P1dB Load Pull Output Power Contours (dBm)

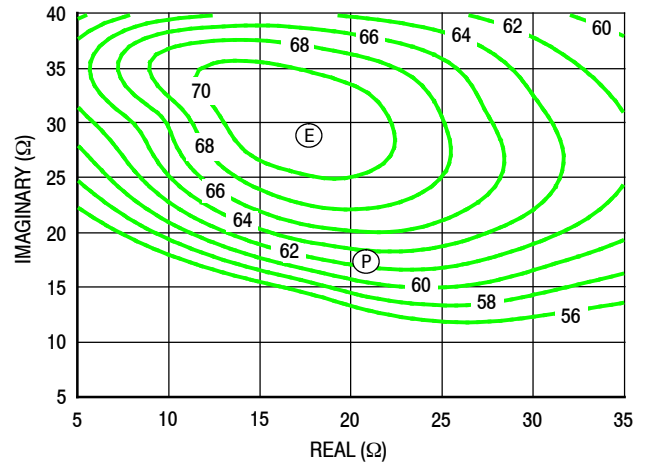

Figure 10. P1dB Load Pull Efficiency Contours (%)

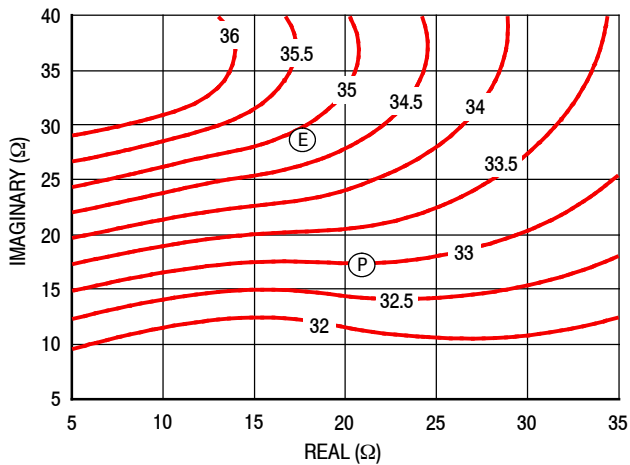

Figure 11. P1dB Load Pull Gain Contours (dB)

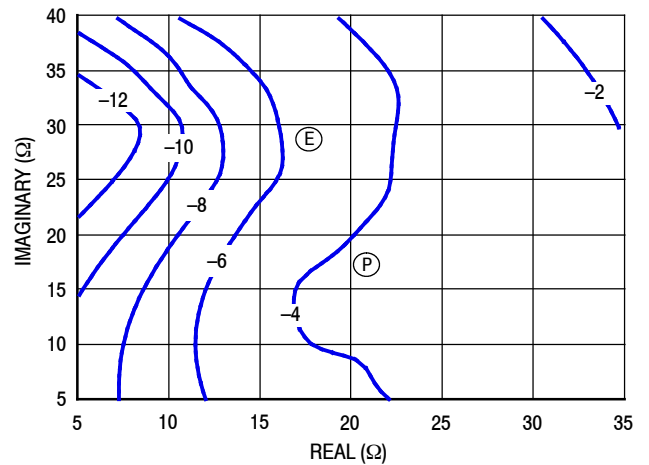

Figure 12. P1dB Load Pull AM/PM Contours (°)

**NOTE:** (P) = Maximum Output Power  
(E) = Maximum Drain Efficiency

- Gain
- Drain Efficiency
- Linearity
- Output Power

### P3dB – TYPICAL LOAD PULL CONTOURS — 940 MHz

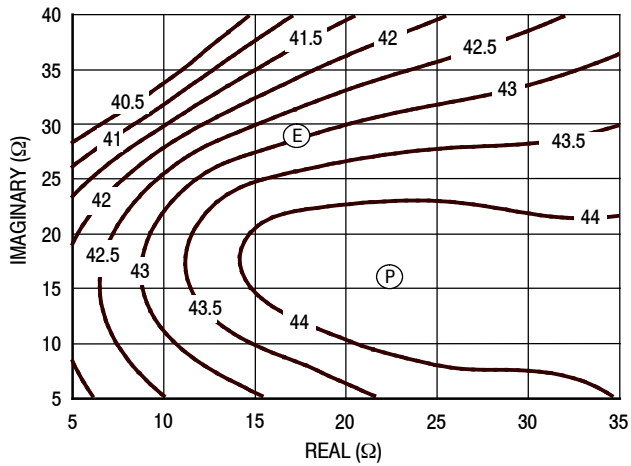

Figure 13. P3dB Load Pull Output Power Contours (dBm)

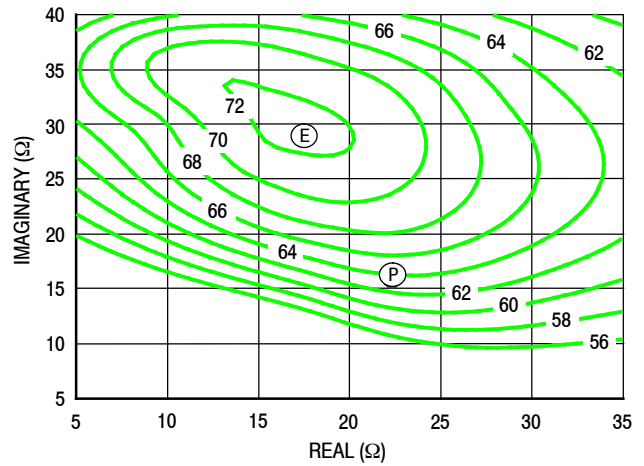

Figure 14. P3dB Load Pull Efficiency Contours (%)

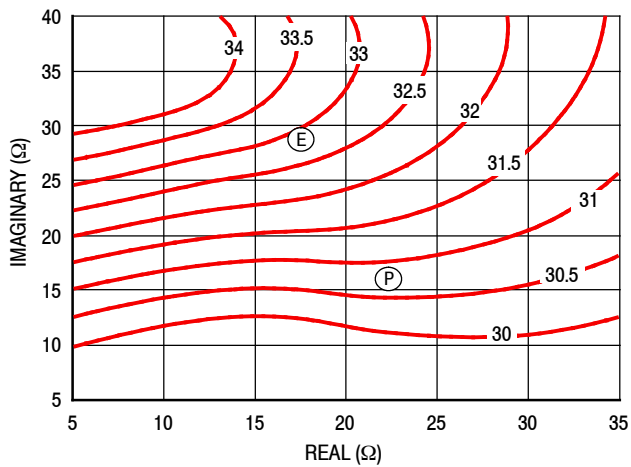

Figure 15. P3dB Load Pull Gain Contours (dB)

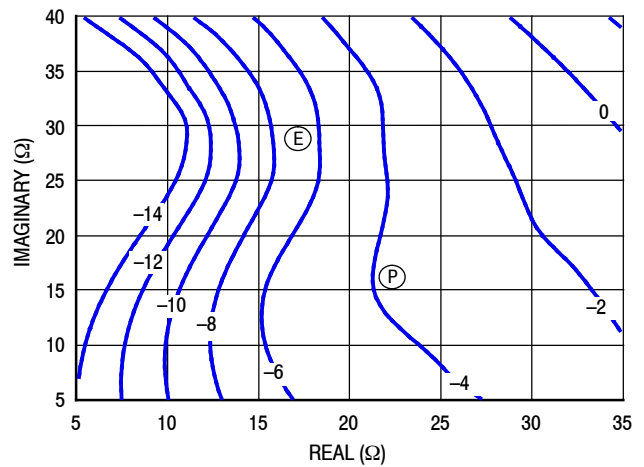

Figure 16. P3dB Load Pull AM/PM Contours (°)

**NOTE:** (P) = Maximum Output Power  
(E) = Maximum Drain Efficiency

- Gain
- Drain Efficiency
- Linearity
- Output Power

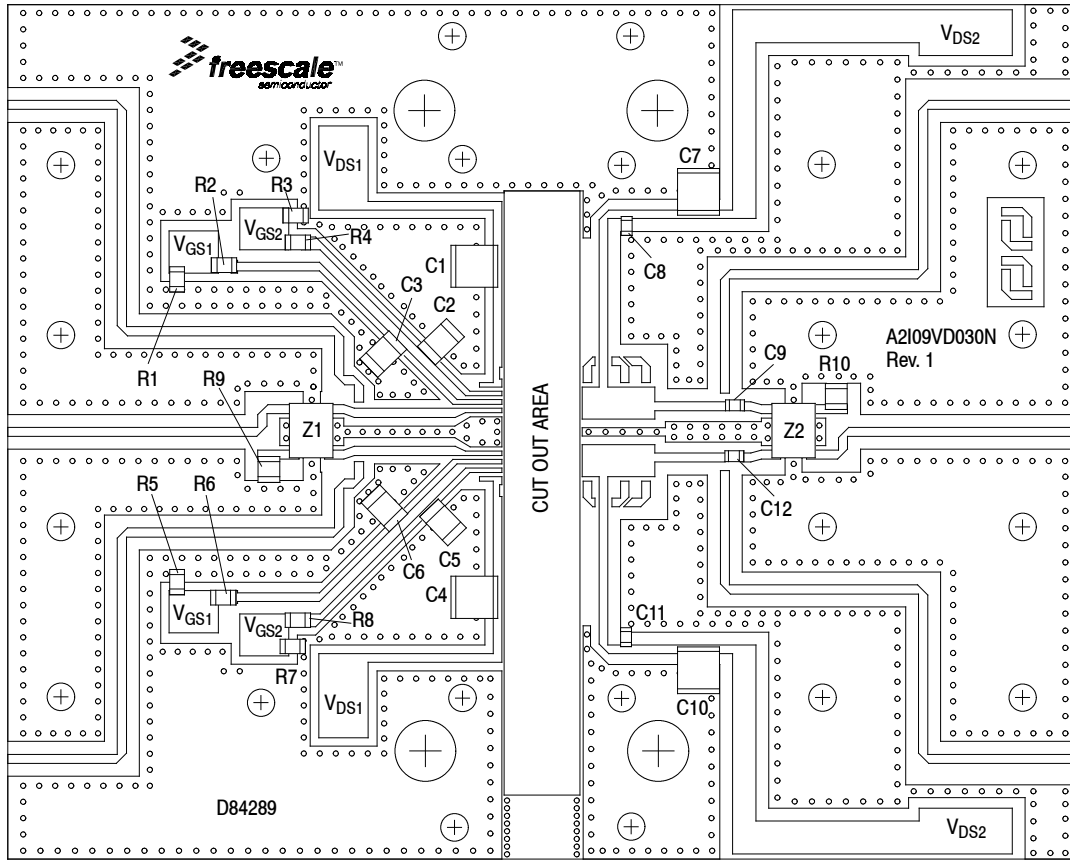
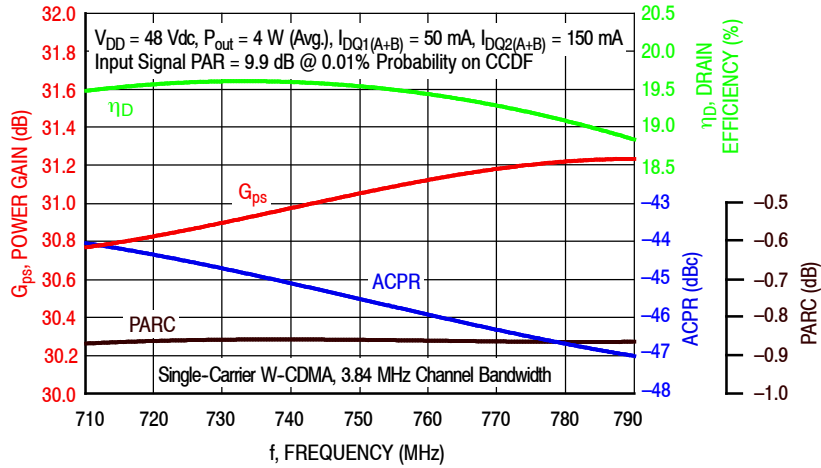

Figure 17. A2109VD030NR1 Test Circuit Component Layout – 728-768 MHz

Table 10. A2109VD030NR1 Test Circuit Component Designations and Values – 728-768 MHz

Part	Description	Part Number	Manufacturer
C1, C4, C7, C10	10 $\mu$ F Chip Capacitor	C5750X7S2A106M	TDK
C2, C3, C5, C6	3.3 $\mu$ F Chip Capacitor	C4532X7R1H335K	TDK
C8, C9, C11, C12	47 pF Chip Capacitor	ATC600F470JT250XT	ATC
R1, R3, R5, R7	51 k $\Omega$ , 1/4 W Chip Resistor	CRCW120651K0JNEA	Vishay
R2, R4, R6, R8	1.5 k $\Omega$ , 1/4 W Chip Resistor	CRCW12061K50FKEA	Vishay
R9, R10	50 $\Omega$ , 4 W Chip Resistor	C10A50Z4	Anaren
Z1, Z2	600-900 MHz, 90°, 3 dB Hybrid Coupler	X3C07P1-03S	Anaren
PCB	Rogers RO4350B, 0.020", $\epsilon_r = 3.66$	D84289	MTL

### TYPICAL CHARACTERISTICS – 728-768 MHz



**Figure 18. Single-Carrier Output Peak-to-Average Ratio Compression (PARC) Broadband Performance @  $P_{out} = 4$  Watts Avg.**

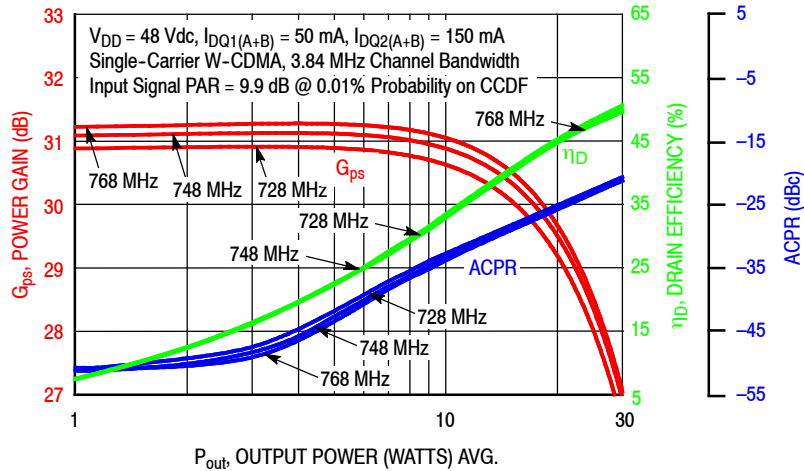

**Figure 19. Single-Carrier W-CDMA Power Gain, Drain Efficiency and ACPR versus Output Power**

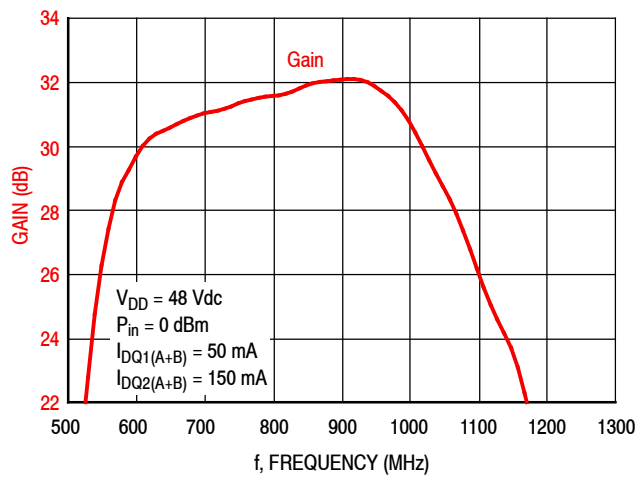

**Figure 20. Broadband Frequency Response**

**Table 11. Load Pull Performance — Maximum Power Tuning**

$V_{DD} = 48 \text{ Vdc}$ ,  $I_{DQ1} = 23 \text{ mA}$ ,  $I_{DQ2} = 77 \text{ mA}$ , Pulsed CW, 10  $\mu\text{sec(ON)}$ , 10% Duty Cycle

f (MHz)	$Z_{\text{source}} (\Omega)$	$Z_{\text{in}} (\Omega)$	Max Output Power					
			P1dB					
			$Z_{\text{load}}^{(1)} (\Omega)$	Gain (dB)	(dBm)	(W)	$\eta_D$ (%)	AM/PM (°)
728	42.7 + j26.4	43.7 – j27.6	25.9 + j7.81	29.6	43.2	21	61.4	–6
748	36.3 + j26.3	42.0 – j25.0	24.9 + j9.30	29.8	43.2	21	61.7	–5
768	39.0 + j25.5	39.7 – j22.1	25.8 + j9.51	30.1	43.4	22	62.1	–4

f (MHz)	$Z_{\text{source}} (\Omega)$	$Z_{\text{in}} (\Omega)$	Max Output Power					
			P3dB					
			$Z_{\text{load}}^{(2)} (\Omega)$	Gain (dB)	(dBm)	(W)	$\eta_D$ (%)	AM/PM (°)
728	42.7 + j26.4	43.0 – j27.1	25.4 + j7.31	27.5	44.0	25	63.7	–6
748	36.3 + j26.3	41.5 – j24.6	24.6 + j8.58	27.7	44.0	25	64.0	–5
768	39.0 + j25.5	39.2 – j21.6	24.9 + j9.05	27.9	44.1	26	64.3	–5

(1) Load impedance for optimum P1dB power.

(2) Load impedance for optimum P3dB power.

$Z_{\text{source}}$  = Measured impedance presented to the input of the device at the package reference plane.

$Z_{\text{in}}$  = Impedance as measured from gate contact to ground.

$Z_{\text{load}}$  = Measured impedance presented to the output of the device at the package reference plane.

**Note: Measurement made on a per side basis.**

**Table 12. Load Pull Performance — Maximum Efficiency Tuning**

$V_{DD} = 48 \text{ Vdc}$ ,  $I_{DQ1} = 23 \text{ mA}$ ,  $I_{DQ2} = 77 \text{ mA}$ , Pulsed CW, 10  $\mu\text{sec(ON)}$ , 10% Duty Cycle

f (MHz)	$Z_{\text{source}} (\Omega)$	$Z_{\text{in}} (\Omega)$	Max Drain Efficiency					
			P1dB					
			$Z_{\text{load}}^{(1)} (\Omega)$	Gain (dB)	(dBm)	(W)	$\eta_D$ (%)	AM/PM (°)
728	42.7 + j26.4	42.1 – j26.9	32.6 + j31.6	31.8	41.2	13	69.9	–7
748	36.3 + j26.3	40.8 – j24.3	29.1 + j25.5	31.6	42.0	16	70.6	–6
768	39.0 + j25.5	38.3 – j21.1	29.1 + j27.5	32.0	42.0	16	71.0	–5

f (MHz)	$Z_{\text{source}} (\Omega)$	$Z_{\text{in}} (\Omega)$	Max Drain Efficiency					
			P3dB					
			$Z_{\text{load}}^{(2)} (\Omega)$	Gain (dB)	(dBm)	(W)	$\eta_D$ (%)	AM/PM (°)
728	42.7 + j26.4	42.4 – j26.7	33.6 + j22.2	29.1	42.9	20	71.4	–6
748	36.3 + j26.3	40.8 – j23.9	29.9 + j23.7	29.5	42.9	20	72.4	–5
768	39.0 + j25.5	38.4 – j20.8	28.8 + j26.3	29.9	42.8	19	72.4	–5

(1) Load impedance for optimum P1dB efficiency.

(2) Load impedance for optimum P3dB efficiency.

$Z_{\text{source}}$  = Measured impedance presented to the input of the device at the package reference plane.

$Z_{\text{in}}$  = Impedance as measured from gate contact to ground.

$Z_{\text{load}}$  = Measured impedance presented to the output of the device at the package reference plane.

**Note: Measurement made on a per side basis.**

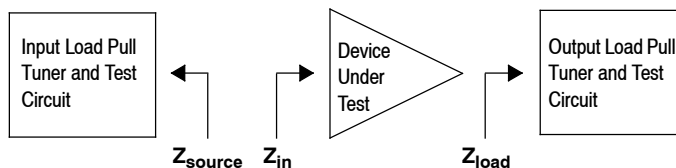

## P1dB – TYPICAL LOAD PULL CONTOURS — 748 MHz

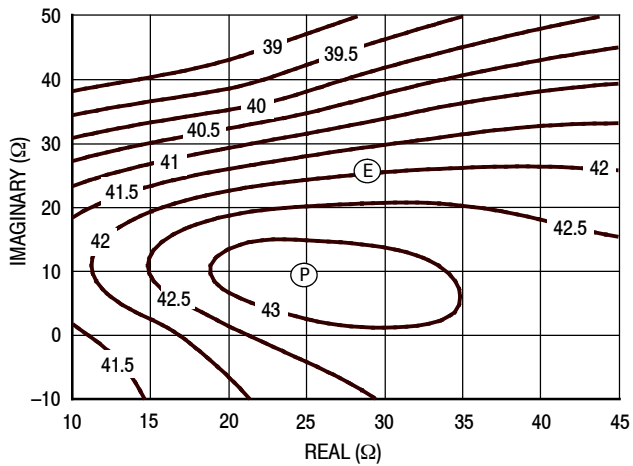

Figure 21. P1dB Load Pull Output Power Contours (dBm)

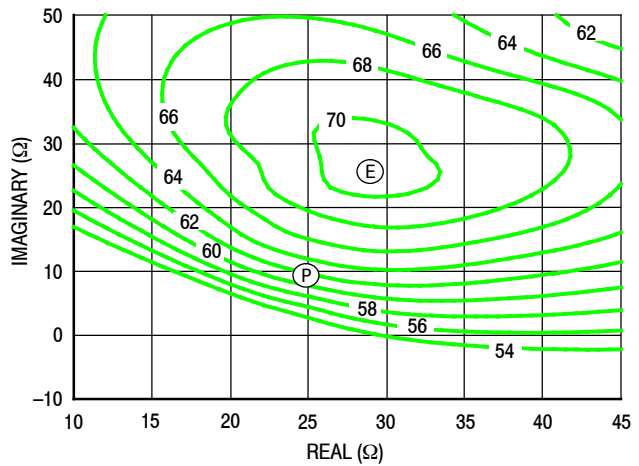

Figure 22. P1dB Load Pull Efficiency Contours (%)

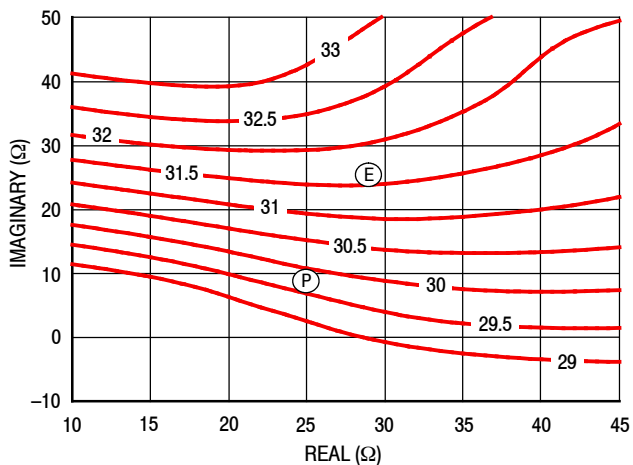

Figure 23. P1dB Load Pull Gain Contours (dB)

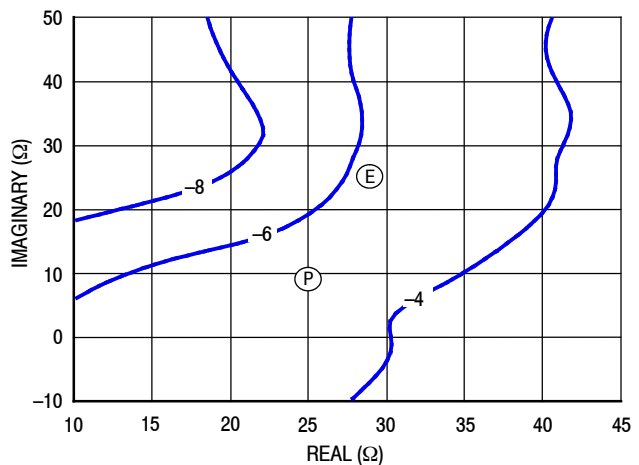

Figure 24. P1dB Load Pull AM/PM Contours (°)

**NOTE:** (P) = Maximum Output Power  
(E) = Maximum Drain Efficiency

- Gain
- Drain Efficiency
- Linearity
- Output Power

P3dB – TYPICAL LOAD PULL CONTOURS — 748 MHz

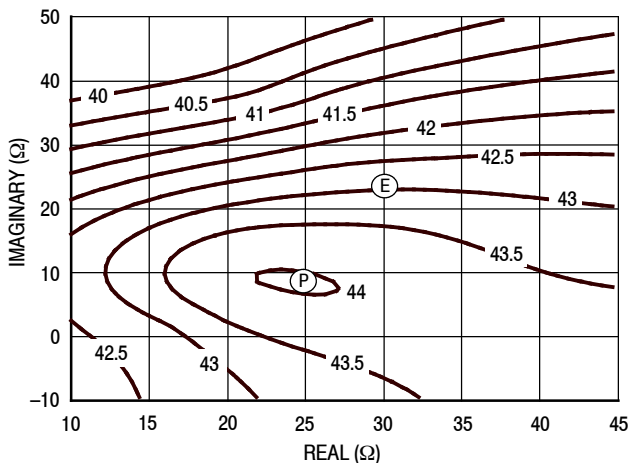

Figure 25. P3dB Load Pull Output Power Contours (dBm)

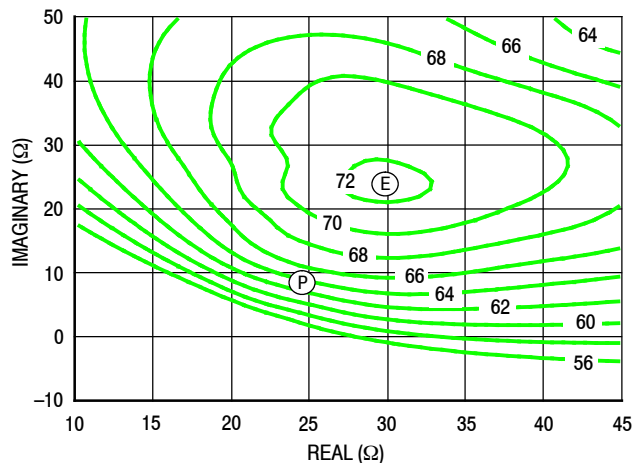

Figure 26. P3dB Load Pull Efficiency Contours (%)

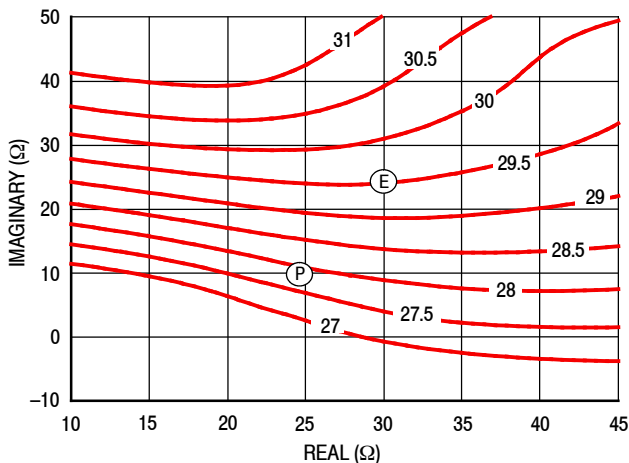

Figure 27. P3dB Load Pull Gain Contours (dB)

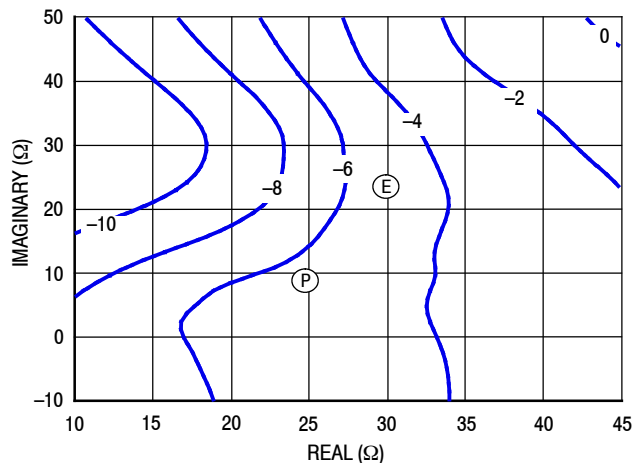
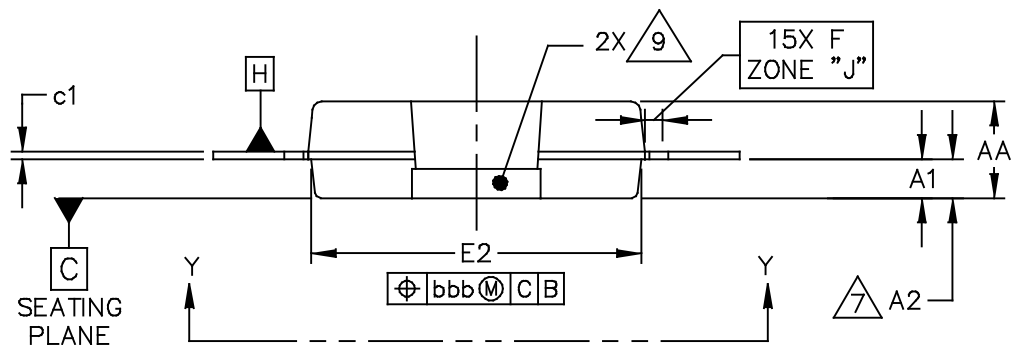
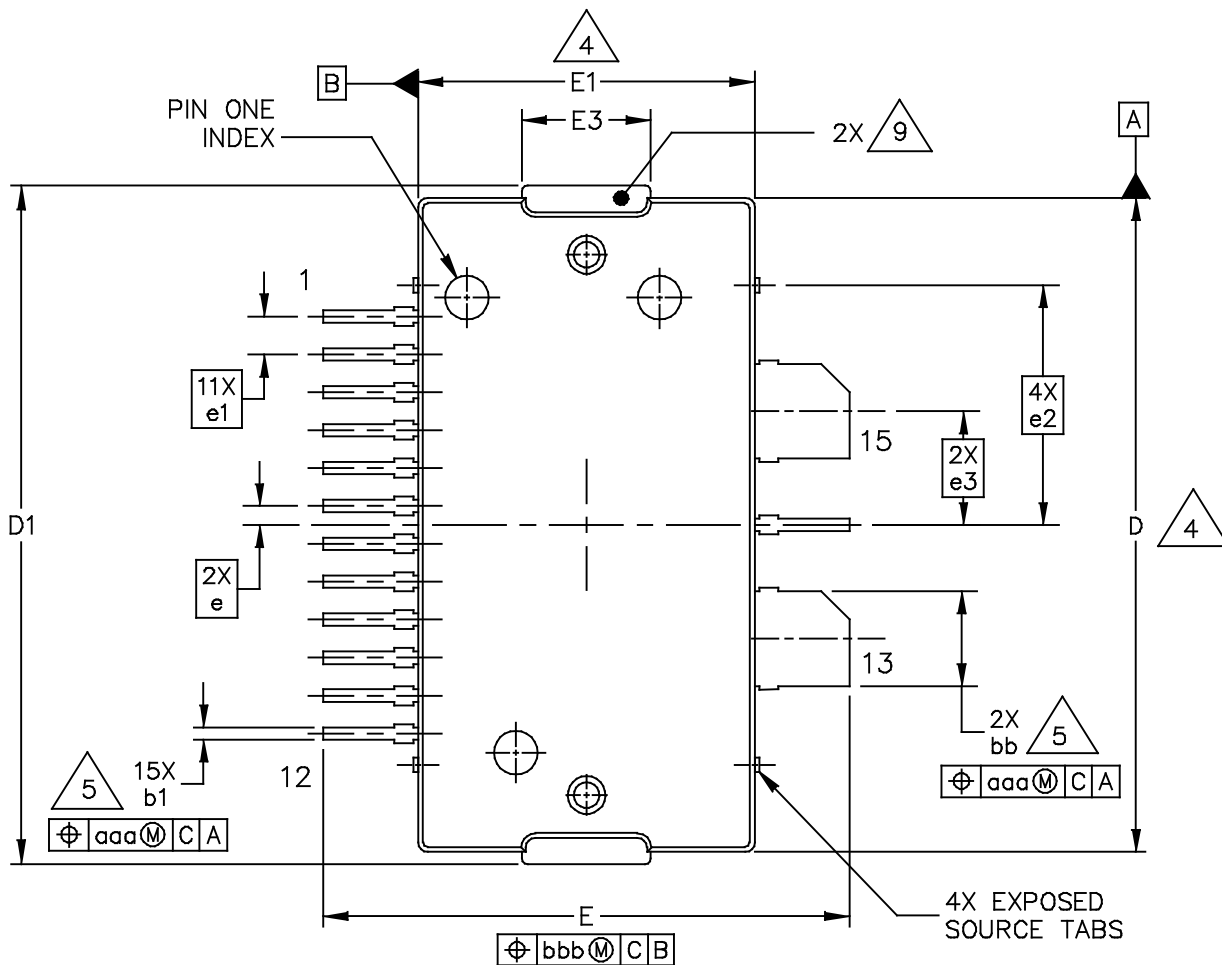

Figure 28. P3dB Load Pull AM/PM Contours (°)

**NOTE:** (P) = Maximum Output Power  
(E) = Maximum Drain Efficiency

- Gain
- Drain Efficiency
- Linearity
- Output Power

PACKAGE DIMENSIONS



© NXP SEMICONDUCTORS N.V. ALL RIGHTS RESERVED	MECHANICAL OUTLINE	PRINT VERSION NOT TO SCALE
TITLE:  TO-270WB-15	DOCUMENT NO: 98ASA00630D      REV: A	STANDARD: NON-JEDEC
SOT1722-1	21 JAN 2016	



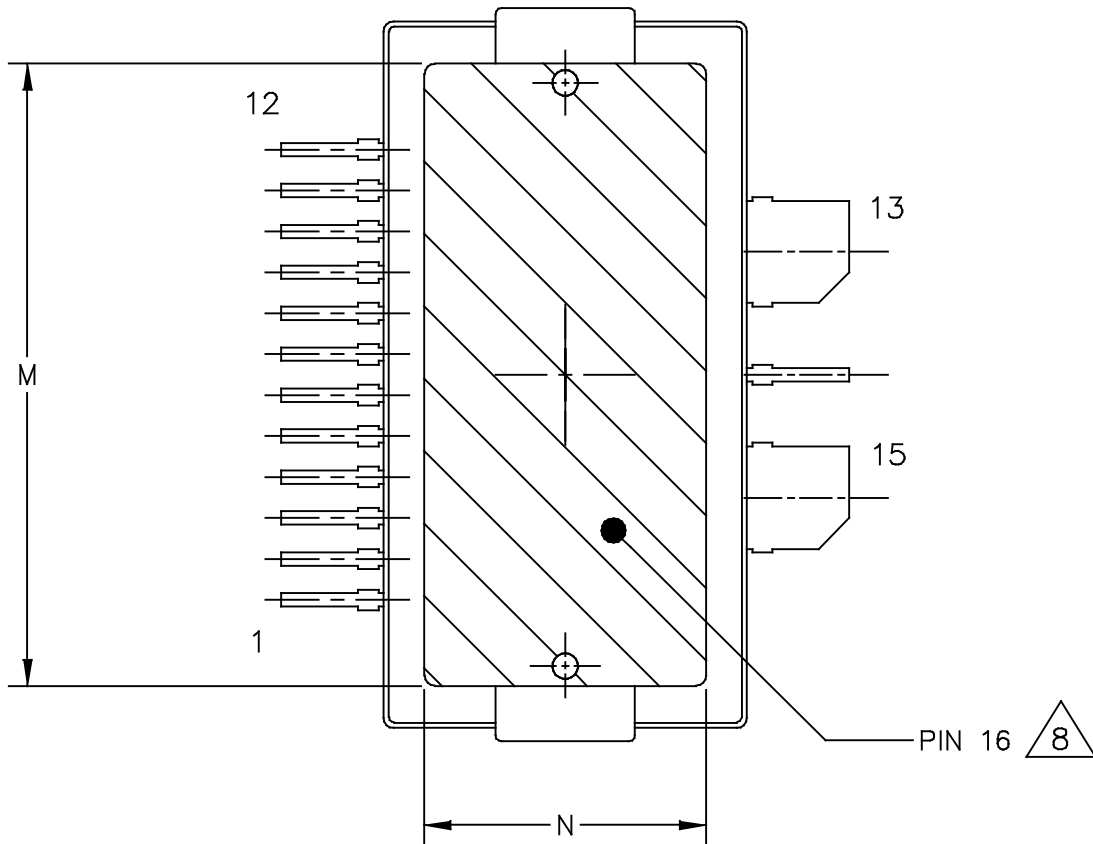

VIEW Y-Y

© NXP SEMICONDUCTORS N.V. ALL RIGHTS RESERVED	MECHANICAL OUTLINE	PRINT VERSION NOT TO SCALE	
TITLE:  TO-270WB-15		DOCUMENT NO: 98ASA00630D	REV: A
		STANDARD: NON-JEDEC	
		SOT1722-1	21 JAN 2016

NOTES:

1. CONTROLLING DIMENSION: INCH
2. INTERPRET DIMENSIONS AND TOLERANCES PER ASME Y14.5M-1994.
3. DATUM PLANE H IS LOCATED AT THE TOP OF LEAD AND IS COINCIDENT WITH THE LEAD WHERE THE LEAD EXITS THE PLASTIC BODY AT THE TOP OF THE PARTING LINE.
4. DIMENSIONS D AND E1 DO NOT INCLUDE MOLD PROTRUSION. ALLOWABLE PROTRUSION IS .006 INCH (0.15 MM) PER SIDE. DIMENSIONS D AND E1 DO INCLUDE MOLD MISMATCH AND ARE DETERMINED AT DATUM PLANE H.
5. DIMENSIONS bb AND b1 DO NOT INCLUDE DAMBAR PROTRUSION. ALLOWABLE DAMBAR PROTRUSION SHALL BE .005 INCH (0.13 MM) TOTAL IN EXCESS OF THE bb AND b1 DIMENSIONS AT MAXIMUM MATERIAL CONDITION.
6. DATUMS A AND B TO BE DETERMINED AT DATUM PLANE H.
7. DIMENSION A2 APPLIES WITHIN ZONE J ONLY.
8. HATCHING REPRESENTS THE EXPOSED AND SOLDERABLE AREA OF THE HEAT SLUG. DIMENSIONS M AND N REPRESENT THE VALUES BETWEEN THE TWO OPPOSITE POINTS ALONG THE EDGES OF EXPOSED AREA OF THE HEAT SLUG.
9. THESE SURFACES OF THE HEAT SLUG ARE NOT PART OF THE SOLDERABLE SURFACES AND MAY REMAIN UNPLATED.

DIM	INCH		MILLIMETER		DIM	INCH		MILLIMETER	
	MIN	MAX	MIN	MAX		MIN	MAX	MIN	MAX
AA	.099	.105	2.51	2.67	M	.600	----	15.24	----
A1	.039	.043	0.99	1.09	N	.270	----	6.86	----
A2	.040	.042	1.02	1.07	bb	.097	.103	2.46	2.62
D	.688	.692	17.48	17.58	b1	.010	.016	0.25	0.41
D1	.712	.720	18.08	18.29	c1	.007	.011	0.18	0.28
E	.551	.559	14.00	14.20	e	.020 BSC		0.51 BSC	
E1	.353	.357	8.97	9.07	e1	.040 BSC		1.02 BSC	
E2	.346	.350	8.79	8.89	e2	.253 INFO ONLY		6.43 INFO ONLY	
E3	.132	.140	3.35	3.56	e3	.120 BSC		3.05 BSC	
F	.025 BSC		0.64 BSC		aaa	.004		0.10	
					bbb	.008		0.20	

© NXP SEMICONDUCTORS N.V. ALL RIGHTS RESERVED		MECHANICAL OUTLINE	PRINT VERSION NOT TO SCALE
TITLE:  TO-270WB-15		DOCUMENT NO: 98ASA00630D      REV: A	
		STANDARD: NON-JEDEC	
		SOT1722-1	21 JAN 2016

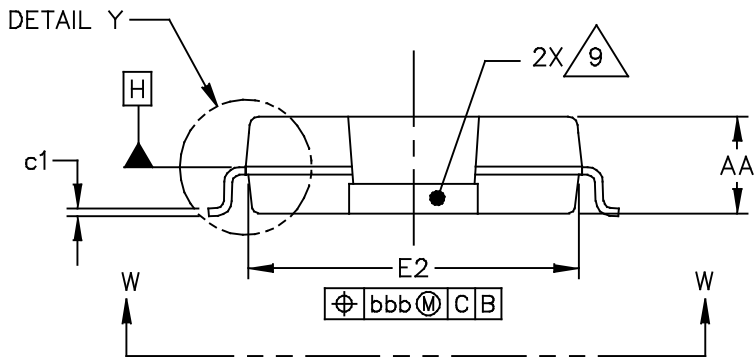
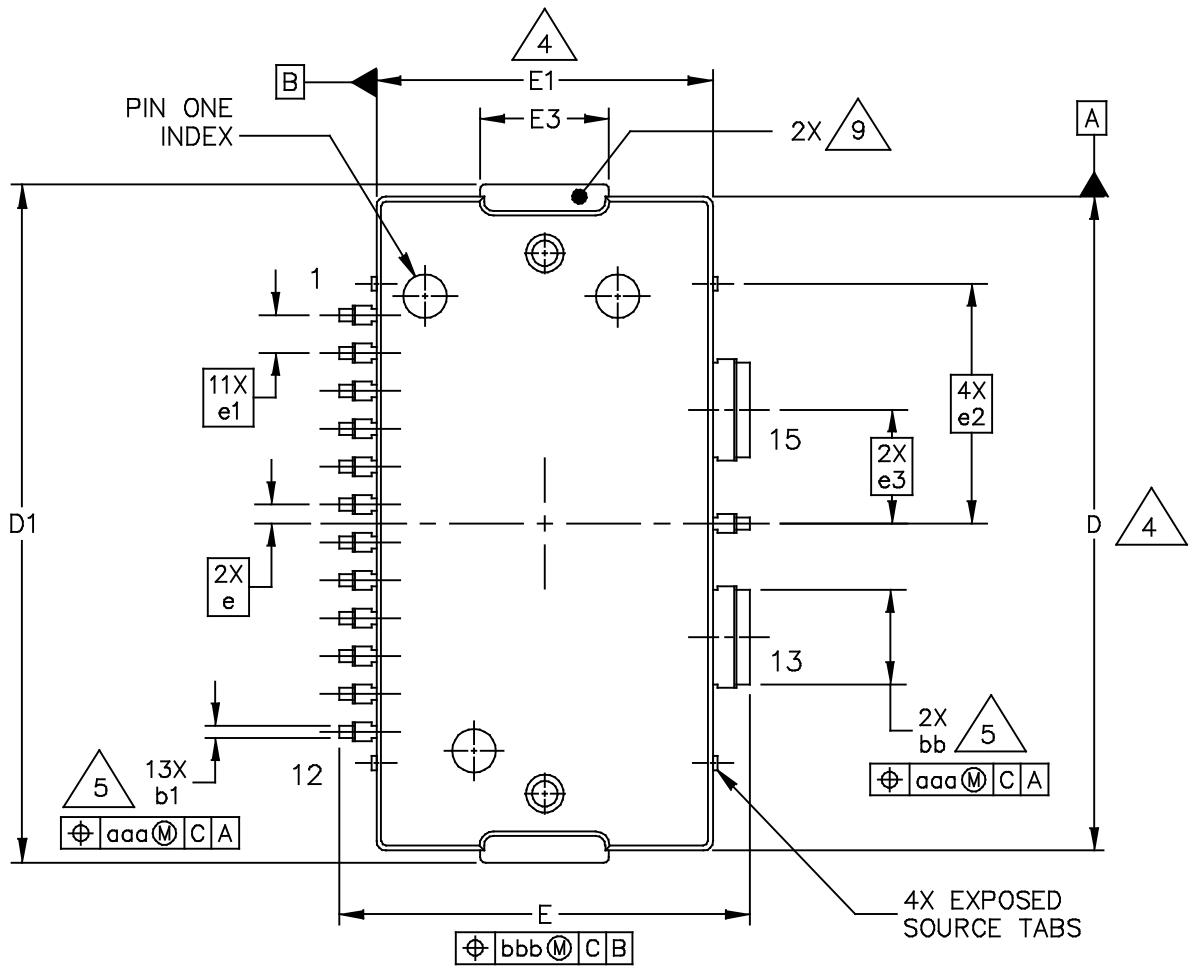

© NXP SEMICONDUCTORS N.V. ALL RIGHTS RESERVED	MECHANICAL OUTLINE	PRINT VERSION NOT TO SCALE
TITLE:  TO-270WBG-15	DOCUMENT NO: 98ASA00684D	REV: A
	STANDARD: NON-JEDEC	
	SOT1722-3	12 JAN 2016

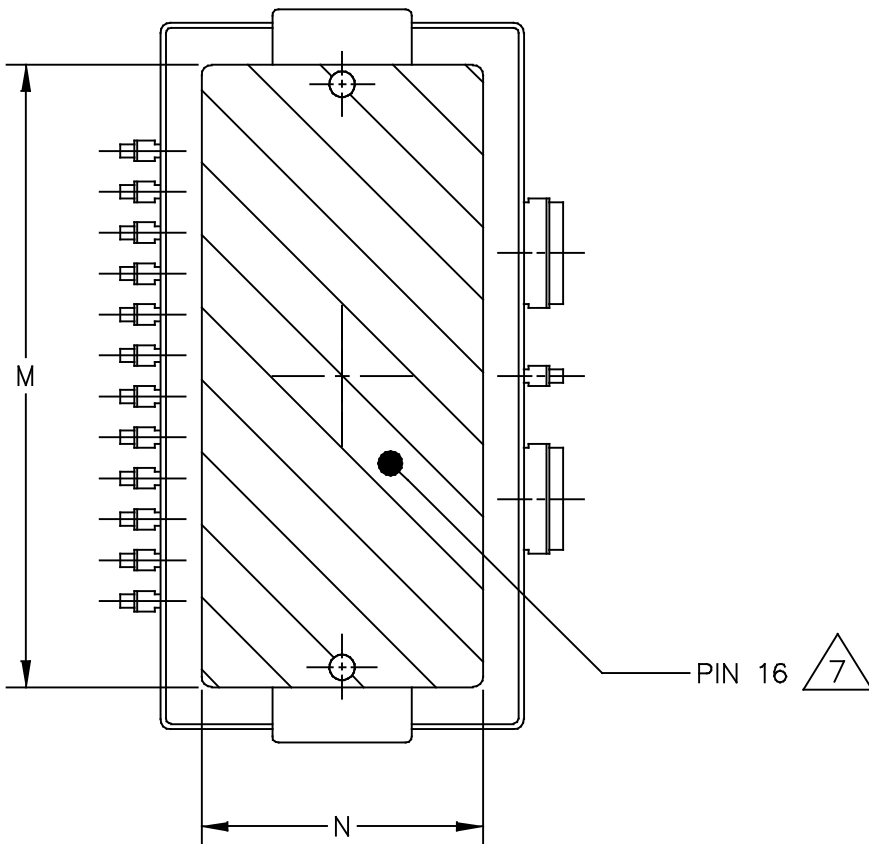

VIEW W-W

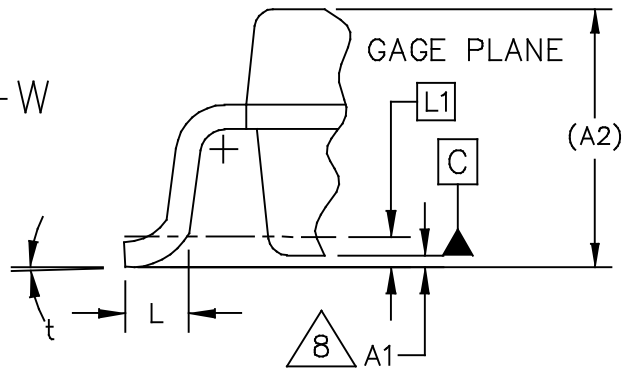

DETAIL "Y"

© NXP SEMICONDUCTORS N.V. ALL RIGHTS RESERVED	MECHANICAL OUTLINE	PRINT VERSION NOT TO SCALE
TITLE:  TO-270WBG-15	DOCUMENT NO: 98ASA00684D	REV: A
	STANDARD: NON-JEDEC	
	SOT1722-3	12 JAN 2016

NOTES:

1. CONTROLLING DIMENSION: INCH
2. INTERPRET DIMENSIONS AND TOLERANCES PER ASME Y14.5M-1994.
3. DATUM PLANE H IS LOCATED AT THE TOP OF LEAD AND IS COINCIDENT WITH THE LEAD WHERE THE LEAD EXITS THE PLASTIC BODY AT THE TOP OF THE PARTING LINE.
4. DIMENSIONS D AND E1 DO NOT INCLUDE MOLD PROTRUSION. ALLOWABLE PROTRUSION IS .006 INCH (0.15 MM) PER SIDE. DIMENSIONS D AND E1 DO INCLUDE MOLD MISMATCH AND ARE DETERMINED AT DATUM PLANE H.
5. DIMENSIONS bb AND b1 DO NOT INCLUDE DAMBAR PROTRUSION. ALLOWABLE DAMBAR PROTRUSION SHALL BE .005 INCH (0.13 MM) TOTAL IN EXCESS OF THE bb AND b1 DIMENSIONS AT MAXIMUM MATERIAL CONDITION.
6. DATUMS A AND B TO BE DETERMINED AT DATUM PLANE H.
7. HATCHING REPRESENTS THE EXPOSED AND SOLDERABLE AREA OF THE HEAT SLUG. DIMENSIONS M AND N REPRESENT THE VALUES BETWEEN THE TWO OPPOSITE POINTS ALONG THE EDGES OF EXPOSED AREA OF THE HEAT SLUG.
8. DIMENSION A1 IS MEASURED WITH REFERENCE TO DATUM C. THE POSITIVE VALUE IMPLIES THAT THE BOTTOM OF THE PACKAGE IS HIGHER THAN THE BOTTOM OF THE LEAD.
9. THESE SURFACES OF THE HEAT SLUG ARE NOT PART OF THE SOLDERABLE SURFACES AND MAY REMAIN UNPLATED.

DIM	INCH		MILLIMETER		DIM	INCH		MILLIMETER	
	MIN	MAX	MIN	MAX		MIN	MAX	MIN	MAX
AA	.099	.105	2.51	2.67	M	.600	----	15.24	----
A1	.001	.004	0.03	0.10	N	.270	----	6.86	----
A2	(.105)		(2.67)		bb	.097	.103	2.46	2.62
D	.688	.692	17.48	17.58	b1	.010	.016	0.25	0.41
D1	.712	.720	18.08	18.29	c1	.007	.011	0.18	0.28
E	.429	.437	10.90	11.10	e	.020 BSC		0.51 BSC	
E1	.353	.357	8.97	9.07	e1	.040 BSC		1.02 BSC	
E2	.346	.350	8.79	8.89	e2	.253 INFO ONLY		6.43 INFO ONLY	
E3	.132	.140	3.35	3.56	e3	.120 BSC		3.05 BSC	
L	.018	.024	0.46	0.61	t	2'	8'	2'	8'
L1	.010 BSC		0.25 BSC		aaa	.004		0.10	
					bbb	.008		0.20	

© NXP SEMICONDUCTORS N.V.  
ALL RIGHTS RESERVED

MECHANICAL OUTLINE

PRINT VERSION NOT TO SCALE

TITLE:

TO-270WBG-15

DOCUMENT NO: 98ASA00684D

REV: A

STANDARD: NON-JEDEC

SOT1722-3

12 JAN 2016

## PRODUCT DOCUMENTATION, SOFTWARE AND TOOLS

Refer to the following resources to aid your design process.

### Application Notes

- AN1907: Solder Reflow Attach Method for High Power RF Devices in Over-Molded Plastic Packages
- AN1955: Thermal Measurement Methodology of RF Power Amplifiers
- AN1977: Quiescent Current Thermal Tracking Circuit in the RF Integrated Circuit Family
- AN1987: Quiescent Current Control for the RF Integrated Circuit Device Family

### Engineering Bulletins

- EB212: Using Data Sheet Impedances for RF LDMOS Devices

### Software

- Electromigration MTTF Calculator
- RF High Power Model
- .s2p File

### Development Tools

- Printed Circuit Boards

### To Download Resources Specific to a Given Part Number:

1. Go to <http://www.nxp.com/RF>
2. Search by part number
3. Click part number link
4. Choose the desired resource from the drop down menu

## REVISION HISTORY

The following table summarizes revisions to this document.

Revision	Date	Description
0	Dec. 2016	• Initial release of data sheet
1	Mar. 2017	• Functional test table: added Output Peak-to-Average Ratio measurement to the functional test table, p. 4

## ***How to Reach Us:***

**Home Page:**  
nxp.com

**Web Support:**  
nxp.com/support

Information in this document is provided solely to enable system and software implementers to use NXP products. There are no express or implied copyright licenses granted hereunder to design or fabricate any integrated circuits based on the information in this document. NXP reserves the right to make changes without further notice to any products herein.

NXP makes no warranty, representation, or guarantee regarding the suitability of its products for any particular purpose, nor does NXP assume any liability arising out of the application or use of any product or circuit, and specifically disclaims any and all liability, including without limitation consequential or incidental damages. "Typical" parameters that may be provided in NXP data sheets and/or specifications can and do vary in different applications, and actual performance may vary over time. All operating parameters, including "typicals," must be validated for each customer application by customer's technical experts. NXP does not convey any license under its patent rights nor the rights of others. NXP sells products pursuant to standard terms and conditions of sale, which can be found at the following address: [nxp.com/SalesTermsandConditions](http://nxp.com/SalesTermsandConditions).

NXP, the NXP logo, Freescale, the Freescale logo, and Airfast are trademarks of NXP B.V. All other product or service names are the property of their respective owners.  
© 2016–2017 NXP B.V.



## Данный компонент на территории Российской Федерации

### Вы можете приобрести в компании MosChip.

Для оперативного оформления запроса Вам необходимо перейти по данной ссылке:

<http://moschip.ru/get-element>

Вы можете разместить у нас заказ для любого Вашего проекта, будь то серийное производство или разработка единичного прибора.

В нашем ассортименте представлены ведущие мировые производители активных и пассивных электронных компонентов.

Нашей специализацией является поставка электронной компонентной базы двойного назначения, продукции таких производителей как XILINX, Intel (ex.ALTERA), Vicor, Microchip, Texas Instruments, Analog Devices, Mini-Circuits, Amphenol, Glenair.

Сотрудничество с глобальными дистрибьюторами электронных компонентов, предоставляет возможность заказывать и получать с международных складов практически любой перечень компонентов в оптимальные для Вас сроки.

На всех этапах разработки и производства наши партнеры могут получить квалифицированную поддержку опытных инженеров.

Система менеджмента качества компании отвечает требованиям в соответствии с ГОСТ Р ИСО 9001, ГОСТ РВ 0015-002 и ЭС РД 009

### Офис по работе с юридическими лицами:

105318, г.Москва, ул.Щербаковская д.3, офис 1107, 1118, ДЦ «Щербаковский»

Телефон: +7 495 668-12-70 (многоканальный)

Факс: +7 495 668-12-70 (доб.304)

E-mail: [info@moschip.ru](mailto:info@moschip.ru)

Skype отдела продаж:

moschip.ru

moschip.ru\_4

moschip.ru\_6

moschip.ru\_9