

The Standard for Photoelectric Sensors with a Secure Track Record of One Million Sold Yearly.

- Long sensing distance of 30 m for Through-beam Models, 4 m for Retro-reflective Models, and 1 m for Diffuse-reflective Models.
- Mechanical axis and optical axis offset of less than $\pm 2.5^\circ$ simplifies optical axis adjustment.
- High stability with unique algorithm that prevents interference of external light.



 Be sure to read *Safety Precautions* on page 15.

Features

Industry's Top-level Sensing Distance with Built-in Amplifier

A separately sold filter is available to prevent mutual interference for Through-beam Models with red lights sources and a sensing distance of 10 m. Reflective Models include functionality to prevent mutual interference.

Long-distance, Through-beam Sensors with a detection distance of 30 m (response time: 2 ms) are also available.



Low-temperature Operation for Applications in Cold-storage Warehouses

A wider ambient operating range from -40 to 55°C (main models with connectors). We also provide Sensor I/O Connectors with PUR Cables for high resistance to cold environments.

Improved Matching of Optical Axis and Mechanical Axis for Through-beam Models and Retro-reflective Models

The offset between the optical axis and the mechanical axis is kept within $\pm 2.5^\circ$, so the optical axis can be accurately set simply by mounting the Sensor according to the mechanical axis.



The receiver will always be in the range of light diffusion.

Sensor Protection against Incorrect Wiring

The Sensor includes output reverse polarity protection. (A diode to protect against reverse polarity is added to the output line.)

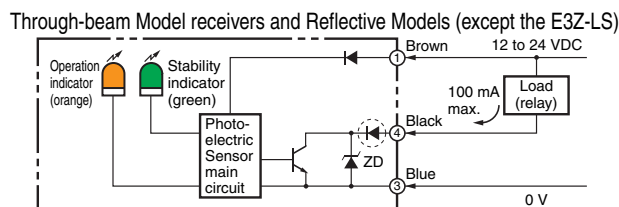

Protection for NPN output models

Complete Compliance with the EU's RoHS Directive

Lead, mercury, cadmium hexachrome, polybrominated biphenyl (PBB), and polybrominated diphenyl ether (PBDE) have all been eliminated. Also, burnable polyethylene packaging has been used.

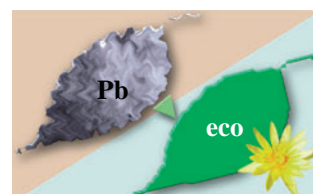

Ordering Information

Sensors [Refer to Dimensions on page 16.]

 Red light  Infrared light

| Sensing method | Appearance | Connection method | Sensing distance | Model | | |
|--|---|---|---|---|--|-------------------|
| | | | | NPN output | PNP output | |
| Through-beam (Emitter + Receiver) *3 |  | Pre-wired (2 m) |  | E3Z-T61 2M Emitter E3Z-T61-L 2M Receiver E3Z-T61-D 2M | E3Z-T81 2M Emitter E3Z-T81-L 2M Receiver E3Z-T81-D 2M | |
| | | Standard M8 connector | | E3Z-T66 Emitter E3Z-T66-L Receiver E3Z-T66-D | E3Z-T86 Emitter E3Z-T86-L Receiver E3Z-T86-D | |
| | | Pre-wired (2 m) |  | E3Z-T61A 2M Emitter E3Z-T61-A-L 2M Receiver E3Z-T61-A-D 2M | E3Z-T81A 2M Emitter E3Z-T81-A-L 2M Receiver E3Z-T81-A-D 2M | |
| | | Standard M8 connector | | E3Z-T66A Emitter E3Z-T66-A-L Receiver E3Z-T66-A-D | E3Z-T86A Emitter E3Z-T86-A-L Receiver E3Z-T86-A-D | |
| | | Pre-wired (2 m) |  | E3Z-T62 2M Emitter E3Z-T62-L 2M Receiver E3Z-T62-D 2M | E3Z-T82 2M Emitter E3Z-T82-L 2M Receiver E3Z-T82-D 2M | |
| | | Standard M8 connector | | E3Z-T67 Emitter E3Z-T67-L Receiver E3Z-T67-D | E3Z-T87 Emitter E3Z-T87-L Receiver E3Z-T87-D | |
| | Emission stop function | Pre-wired (2 m) |  | E3Z-T62-G0 2M *4 Emitter E3Z-T62-G0-L 2M Receiver E3Z-T62-G0-D 2M | E3Z-T82-G0 2M *4 Emitter E3Z-T82-G0-L 2M Receiver E3Z-T82-G0-D 2M | |
| | | Standard M8 connector | | E3Z-T67-G0 *4 Emitter E3Z-T67-G0-L Receiver E3Z-T67-G0-D | E3Z-T87-G0 *4 Emitter E3Z-T87-G0-L Receiver E3Z-T87-G0-D | |
| | Retro-reflective with MSR function |  *1 | Pre-wired (2 m) |  | E3Z-R61 2M | E3Z-R81 2M |
| | | Standard M8 connector | E3Z-R66 | | E3Z-R86 | |
| | Diffuse-reflective |  | Pre-wired (2 m) |  | E3Z-D61 2M | E3Z-D81 2M |
| | | | Standard M8 connector | | E3Z-D66 | E3Z-D86 |
| Pre-wired (2 m) | |  | E3Z-D62 2M | E3Z-D82 2M | | |
| Standard M8 connector | | | E3Z-D67 | E3Z-D87 | | |
| Pre-wired (2 m) | |  | E3Z-L61 2M | E3Z-L81 2M | | |
| Standard M8 connector | | | E3Z-L66 | E3Z-L86 | | |
| Distance-settable Refer to E3Z-LS . |  | Pre-wired (2 m) |  | E3Z-LS61 2M | E3Z-LS81 2M | |
| | | Standard M8 Connector | | E3Z-LS66 | E3Z-LS86 | |
| | | Pre-wired (2 m) |  | E3Z-LS63 2M | E3Z-LS83 2M | |
| | | Standard M8 connector | | E3Z-LS68 | E3Z-LS88 | |
| Slit-type Through-beam Refer to E3Z-G . |  | Pre-wired (2 m) |  | E3Z-G61 2M | E3Z-G81 2M | |
| | | 2 axes | | E3Z-G62 2M | E3Z-G82 2M | |
| | | Pre-wired M8 connector | | E3Z-G61-M3J | E3Z-G81-M3J | |
| | | 2 axes | | E3Z-G62-M3J | E3Z-G82-M3J | |
| Limited-reflective for transparent glasses |  | Pre-wired (2 m) |  | E3Z-L63 2M | E3Z-L83 2M | |
| | | Standard M8 connector | | E3Z-L68 | E3Z-J88 | |
| Retro-reflective without MSR function for clear, plastic bottles |  | Pre-wired (2 m) |  | E3Z-B61 2M | E3Z-B81 2M | |
| | | Standard M8 connector | | E3Z-B66 | E3Z-B86 | |
| | | Pre-wired (2 m) |  | E3Z-B62 2M | E3Z-B82 2M | |
| | | Standard M8 connector | | E3Z-B67 | E3Z-B87 | |

*1. The Reflector is sold separately. Select the Reflector model most suited to the application.

*2. The sensing distance specified is possible when the E39-R1S is used. Values in parentheses indicate the minimum required distance between the Sensor and Reflector.

*3. Through-beam Sensors are normally sold in sets that include both the Emitter and Receiver.

Orders for individual Emitters and Receivers are accepted. (Modifications are required for some models. Ask your OMRON representative for details.)

*4. Models with emission stop function. Refer to page 8, Photoelectric Sensors Technical Guide for details.

Variety of Connection Specifications

The models with the connection specifications marked with a black circle in the table are available.
The model number indication is a combination of the basic model and the connection specification.

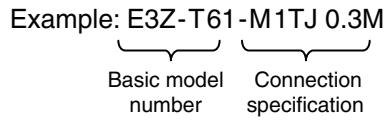

NPN Output

| Model | | | Model number example | E3Z-T61 -M1TJ 0.3M | E3Z-T61 0.5M | E3Z-T61 5M | E3Z-T61 -M1J 0.3M | E3Z-T61 -M3J 0.3M | E3Z-T61 -ECON 0.3M E3Z-T61 -ECON 0.5M | E3Z-T61 -ECON 2M |
|---|------------------|-----------------|--------------------------------------|---|---------------------------------|-------------------------------|--|---|---|---|
| Sensing method | Sensing distance | Main features | Conne- tion specifi- cation | M12 pre-wired Smart-click connector (cable length: 0.3 m) | Pre-wired (cable length: 0.5 m) | Pre-wired (cable length: 5 m) | M12 pre-wired standard connector (cable length: 0.3 m) | M8, 4-pin pre-wired connector (cable length: 0.3 m) | e-CON pre-wired connector (cable length: 0.3 m/0.5 m) | e-CON pre-wired connector (cable length: 2 m) |
| | | | Basic model number | -M1TJ 0.3M | 0.5M | 5M | -M1J 0.3M | -M3J 0.3M | -ECON 0.3M -ECON 0.5M | -ECON 2M |
| Through-beam | 15 m | Infrared light | E3Z-T61 | ● | ● | ● | ● | ● | ● | ● |
| | 10 m | Red light | E3Z-T61A | --- | ● | ● | ● | --- | ● | ● |
| | 30 m | 2-ms response | E3Z-T62 | --- | ● | --- | --- | --- | --- | --- |
| Retro-reflective | 4 m | MSR function | E3Z-R61 | ● | ● | ● | ● | ● | ● | ● |
| Diffuse-reflective (narrow-beam reflective) | 100 mm | Wide view | E3Z-D61 | --- | ● | ● | ● | ● | ● | ● |
| | 1 m | Long distance | E3Z-D62 | ● | ● | ● | ● | ● | ● | ● |
| | 90 mm | Narrow beam | E3Z-L61 | ● | ● | ● | ● | --- | ● | ● |
| Distance-settable | 200 mm | FGS function | E3Z-LS61 | --- | ● | ● | ● | ● | ● | ● |
| | 80 mm | Small spot | E3Z-LS63 | --- | ● | --- | --- | --- | --- | --- |
| Slit-type | 25 mm | 1 optical axis | E3Z-G61 | ● | ● | ● | ● | ● | ● | ● |
| | | 2 optical axes | E3Z-G62 | --- | ● | ● | ● | ● | ● | ● |
| Retro-reflective for clear, plastic bottles | 500 mm | No MSR function | E3Z-B61 | --- | ● | ● | --- | --- | ● | ● |
| | 2 m | | E3Z-B62 | --- | ● | ● | ● | --- | ● | ● |

Clamp-type e-CON pre-wired connectors are also available for models shaded in .
Add "-ECON-C 2M" after the basic model number to specify the connectors.

PNP Output

| Model | | | Model number example | E3Z-T81 -M1TJ 0.3M | E3Z-T81 0.5M | E3Z-T81 5M | E3Z-T81 -M1J 0.3M | E3Z-T81 -M3J 0.3M |
|---|------------------|-----------------|--------------------------|--|---------------------------------|-------------------------------|--|---|
| Sensing method | Sensing distance | Main features | Connection specification | M12 pre-wired Smartclick connector (cable length: 0.3 m) | Pre-wired (cable length: 0.5 m) | Pre-wired (cable length: 5 m) | M12 pre-wired standard connector (cable length: 0.3 m) | M8, 4-pin pre-wired connector (cable length: 0.3 m) |
| | | | Basic model number | -M1TJ 0.3M | 0.5M | 5M | -M1J 0.3M | -M3J 0.3M |
| Through-beam | 15 m | Infrared light | E3Z-T81 | ● | ● | ● | ● | ● |
| | 10 m | Red light | E3Z-T81A | --- | --- | --- | ● | --- |
| | 30 m | 2-ms response | E3Z-T82 | --- | ● | --- | --- | --- |
| Retro-reflective | 4 m | MSR function | E3Z-R81 | ● | ● | ● | ● | ● |
| Diffuse-reflective (narrow-beam reflective) | 100 mm | Wide view | E3Z-D81 | ● | ● | ● | ● | ● |
| | 1 m | Long distance | E3Z-D82 | ● | ● | ● | ● | ● |
| | 90 mm | Narrow beam | E3Z-L81 | ● | ● | ● | ● | --- |
| Distance-settable | 200 mm | FGS function | E3Z-LS81 | --- | ● | ● | ● | ● |
| | 80 mm | Small spot | E3Z-LS83 | --- | ● | --- | --- | --- |
| Slit-type | 25 mm | 1 optical axis | E3Z-G81 | ● | ● | --- | ● | ● |
| | | 2 optical axes | E3Z-G82 | --- | ● | --- | ● | ● |
| Retro-reflective for clear, plastic bottles | 500 mm | No MSR function | E3Z-B81 | --- | ● | --- | ● | --- |
| | 2 m | | E3Z-B82 | --- | ● | ● | ● | --- |

Oil-resistive Sensors [Refer to *Dimensions on page 16.*]

 Red light  Infrared light

| Sensing method | Appearance | Connection method | Sensing distance | Model | | |
|--------------------------------------|---|------------------------|---|---|---|--------------------------|
| | | | | NPN output | PNP output | |
| Through-beam (Emitter + Receiver) *3 |  | Pre-wired (2 m) |  | E3Z-T61K 2M Emitter E3Z-T61K-L 2M Receiver E3Z-T61K-D 2M | E3Z-T81K 2M Emitter E3Z-T81K-L 2M Receiver E3Z-T81K-D 2M | |
| | | Pre-wired M8 connector | | E3Z-T61K-M3J 0.3M Emitter E3Z-T61K-L-M3J 2M Receiver E3Z-T61K-D-M3J 2M | E3Z-T81K-M3J 0.3M Emitter E3Z-T81K-L-M3J 2M Receiver E3Z-T81K-D-M3J 2M | |
| Retro-reflective with MSR function |  | Pre-wired (2 m) |  | E3Z-R61K 2M | E3Z-R81K 2M | |
| | | Pre-wired M8 connector | | E3Z-R61K-M3J 0.3M | E3Z-R81K-M3J 0.3M | |
| Diffuse-reflective |  | Pre-wired (2 m) |  | E3Z-D61K 2M | E3Z-D81K 2M | |
| | | Pre-wired M8 connector | | E3Z-D61K-M3J 0.3M | E3Z-D81K-M3J 0.3M | |
| | | Pre-wired (2 m) | |  | E3Z-D62K 2M | E3Z-D82K 2M |
| | | Pre-wired M8 connector | | | E3Z-D62K-M3J 0.3M | E3Z-D82K-M3J 0.3M |

*1. The Reflector is sold separately. Select the Reflector model most suited to the application.
 *2. The sensing distance specified is possible when the E39-R1S is used. Values in parentheses indicate the minimum required distance between the Sensor and Reflector.
 *3. Through-beam Sensors are normally sold in sets that include both the Emitter and Receiver.
 Orders for individual Emitters and Receivers are accepted. (Modifications are required for some models. Ask your OMRON representative for details.)

Accessories (Order Separately)

Slit (A Slit is not provided with Through-beam Sensors) Order a Slit separately if required. [Refer to *Dimensions on page 18.*]

| Slit width | Sensing distance | | Minimum detectable object (typical) | Model | Contents |
|-------------|------------------|----------|-------------------------------------|-----------------|--|
| | E3Z-T□□ | E3Z-T□□A | | | |
| 0.5-mm dia. | 50 mm | 35 mm | 0.2-mm dia. | E39-S65A | One set (contains Slits for both the Emitter and Receiver) |
| 1-mm dia. | 200 mm | 150 mm | 0.4-mm dia. | E39-S65B | |
| 2-mm dia. | 800 mm | 550 mm | 0.7-mm dia. | E39-S65C | |
| 0.5 × 10 mm | 1 m | 700 mm | 0.2-mm dia. | E39-S65D | |
| 1 × 10 mm | 2.2 m | 1.5 m | 0.5-mm dia. | E39-S65E | |
| 2 × 10 mm | 5 m | 3.5 m | 0.8-mm dia. | E39-S65F | |

Reflectors (Reflector required for Retroreflective Sensors) A Reflector is not provided with the Sensor. Be sure to order a Reflector separately. [Refer to *Dimensions on E39-L/F39-L/E39-S/E39-R*]

| Name | Sensing distance (typical)* | | | | Model | Quantity | Remarks |
|------------------------|-----------------------------|----------------------------|------------------------------|----------------------------|----------------|----------|---|
| | E3Z-R | E3Z-R□K | E3Z-B□1/-B□6 | E3Z-B□2/-B□7 | | | |
| Reflector | 3 m (100 mm) (rated value) | 2 m (100 mm) (rated value) | --- | --- | E39-R1 | 1 | <ul style="list-style-type: none"> • Retro-reflective models are not provided with Reflectors. • The MSR function is enabled. |
| | 4 m (100 mm) (rated value) | 3 m (150 mm) (rated value) | 500 mm (80 mm) (rated value) | 2 m (500 mm) (rated value) | E39-R1S | 1 | |
| | 5 m (100 mm) | --- | --- | --- | E39-R2 | 1 | |
| | 2.5 m (100 mm) | --- | --- | --- | E39-R9 | 1 | |
| | 3.5 m (100 mm) | --- | --- | --- | E39-R10 | 1 | |
| Fog Preventive Coating | 3 m (100 mm) | --- | 500 mm (80 mm) (rated value) | 2 m (500 mm) (rated value) | E39-R1K | 1 | |
| Small Reflector | 1.5 m (50 mm) | --- | --- | --- | E39-R3 | 1 | |
| Tape Reflector | 700 mm (150 mm) | --- | --- | --- | E39-RS1 | 1 | |
| | 1.1 m (150 mm) | --- | --- | --- | E39-RS2 | 1 | |
| | 1.4 m (150 mm) | --- | --- | --- | E39-RS3 | 1 | |

Note: The actual sensing distance may be reduced to approximately 70% of the typical sensing distance when using a Reflector other than E39-R1 or E39-R1S.









*1. Refer to *Reflectors on E39-L/F39-L/E39-S/E39-R* for details.
 *2. Values in parentheses indicates the minimum required distance between the Sensor and Reflector.

Mutual Interference Protection Filter A Filter is not provided with the Sensor (for the through-beam E3Z-T□□A). Order a Filter separately if required.

| Sensing distance | Appearance/Dimensions | Model | Quantity | Remarks |
|------------------|---|----------------|---|--|
| 3 m |  | E39-E11 | Two sets each for the Emitter and Receiver (total of four pieces) | Can be used with the E3Z-T□□A Through-beam models. The arrow indicates the direction of polarized light. Mutual interference can be prevented by altering the direction of polarized light from or to adjacent Emitters and Receivers. |

Mounting Brackets A Mounting Bracket is not enclosed with the Sensor. Order a Mounting Bracket separately if required.

[Refer to *Dimensions on E39-L/F39-L/E39-S/E39-R*]

| Appearance | Model (material) | Quantity | Remarks | Appearance | Model (material) | Quantity | Remarks |
|---|----------------------|----------|-------------------------------------|---|----------------------|----------|--|
|  | E39-L153 (SUS304) *1 | 1 | Mounting Brackets |  | E39-L98 (SUS304) *2 | 1 | Metal Protective Cover Bracket |
|  | E39-L104 (SUS304) *1 | 1 | |  | E39-L150 (SUS304) | 1 | (Sensor adjuster) |
|  | E39-L43 (SUS304) *2 | 1 | Horizontal Mounting Brackets |  | E39-L151 (SUS304) | 1 | Easily mounted to the aluminum frame rails of conveyors and easily adjusted. |
|  | E39-L142 (SUS304) *2 | 1 | Horizontal Protective Cover Bracket | | | | For left to right adjustment |
|  | E39-L44 (SUS304) | 1 | Rear Mounting Bracket |  | E39-L144 (SUS304) *2 | 1 | Compact Protective Cover Bracket (For E3Z only) |

Note: 1. When using Through-beam models, order one bracket for the Receiver and one for the Emitter.

2. Refer to *Mounting Brackets on E39-L/F39-L/E39-S/E39-R* for details.

*1. Cannot be used for Standard Connector models with mounting surface on the bottom. In that case, use Pre-wired Connector models.

*2. Cannot be used for Standard Connector models.

Sensor I/O Connectors

(Models for Connectors and Pre-wired Connectors: A Connector is not provided with the Sensor. Be sure to order a Connector separately.)

[Refer to *Dimensions for XS3, XS2, XS5. For e-CON, inquire.*]

| Size | Cable | Appearance | Cable type | Model | |
|-----------------------------|--|---|------------|-----------------|-----------------|
| M8 *1 | Standard | Straight *3  | 2 m | 4-wire | XS3F-M421-402-A |
| | | | 5 m | | XS3F-M421-405-A |
| | | L-shaped *3 *4  | 2 m | | XS3F-M422-402-A |
| | | | 5 m | | XS3F-M422-405-A |
| M12 *1 (For -M1J models) | | Straight *3  | 2 m | 3-wire | XS2F-D421-DC0-A |
| | | | 5 m | | XS2F-D421-GC0-A |
| | | L-shaped *3  | 2 m | | XS2F-D422-DC0-A |
| | | | 5 m | | XS2F-D422-GC0-A |
| M12 (For -M1TJ models) | Straight  | 2 m | 4-wire | XS5F-D421-D80-A | |
| | | 5 m | | XS5F-D421-G80-A | |
| e-CON | Single-end connector  | 2 m | 4-wire | E39-ECON2M | |
| | | 5 m | | E39-ECON5M | |
| | | Double-end connectors  | | 0.5 to 1 m | E39-ECONW□M |
| | | 1.1 to 1.5 m | | | |
| M8 | PUR (Polyurethane) cable *2 | Straight *3  | 2 m | 4-wire | XS3F-M421-402-L |
| | | | 5 m | | XS3F-M421-405-L |
| | | L-shaped *3 *4  | 2 m | | XS3F-M422-402-L |
| | | | 5 m | | XS3F-M422-405-L |

Note: When using Through-beam models, order one connector for the Receiver and one for the Emitter.

*1. Refer to *Introduction to Sensor I/O Connectors* for details.

*2. The Sensor can be used in low-temperature environments (−25°C to −40°C). Do not use the Sensor in locations that are subject to oil.

*3. The connector will not rotate after connecting.

*4. The cable is fixed at an angle of 180° from the sensor emitter/receiver surface.

Ratings and Specifications

| Item | Sensing method | | Through-beam | | | Retro-reflective with MSR function | Diffuse-reflective | | (Narrow-beam Models) | |
|-------------------------------------|-----------------------|----------------|---|-----------------------------|-----------------------------|---|--|---------------------------------------|--|--|
| | Model | | E3Z-T61 | E3Z-T62 | E3Z-T61A | E3Z-R61 | E3Z-D61 | E3Z-D62 | E3Z-L61 | |
| | NPN output | Pre-wired | E3Z-T61 | E3Z-T62 | E3Z-T61A | E3Z-R61 | E3Z-D61 | E3Z-D62 | E3Z-L61 | |
| | | Connector (M8) | E3Z-T66 | E3Z-T67 | E3Z-T66A | E3Z-R66 | E3Z-D66 | E3Z-D67 | E3Z-L66 | |
| | PNP output | Pre-wired | E3Z-T81 | E3Z-T82 | E3Z-T81A | E3Z-R81 | E3Z-D81 | E3Z-D82 | E3Z-L81 | |
| | | Connector (M8) | E3Z-T86 | E3Z-T87 | E3Z-T86A | E3Z-R86 | E3Z-D86 | E3Z-D87 | E3Z-L86 | |
| Sensing distance | | | 15 m | 30 m | 10 m | 4 m (100 mm) *1 (when using E39-R1S) 3 m (100 mm) *1 (when using E39-R1) | 100 mm (white paper: 100 × 100 mm) | 1 m (white paper: 300 × 300 mm) | 90 + 30 mm (white paper, 100 x 100 mm) | |
| Spot diameter (typical) | | | --- | | | | | | (2.5 dia. and sensing distance of 90 mm) | |
| Standard sensing object | | | Opaque: 12-mm dia. min. | | | Opaque: 75-mm dia. min. | | --- | | |
| Minimum detectable object (typical) | | | --- | | | | | | 0.1 mm (copper wire) | |
| Differential travel | | | --- | | | | 20% max. of setting distance | | Refer to <i>Engineering data</i> on page 10. | |
| Directional angle | | | Both emitter and receiver: 3 to 15° | | | 2 to 10° | | --- | | |
| Light source (wavelength) | | | Infrared LED (870 nm) | | Red LED (660 nm) | Red LED (660 nm) | Infrared LED (860 nm) | | Red LED (650 nm) | |
| Current consumption | | | 35 mA max. (Emitter: 15 mA max., Receiver: 20 mA max.) | | | 30 mA max. | | | | |
| Protection circuits | | | Reversed power supply polarity protection, Output short-circuit protection, and Reversed output polarity protection | | | Reversed power supply polarity protection, Output short-circuit protection, Mutual interference prevention, and Reversed output polarity protection | | | | |
| Response time | | | Operate or reset: 1 ms max. | Operate or reset: 2 ms max. | Operate or reset: 1 ms max. | | | | | |
| Degree of protection | | | IEC, IP67 | | | | | | | |
| Connection method | | | Pre-wired cable (standard length: 2 m and 0.5 m), Connector (M8) | | | | | | | |
| Weight (packed state) | Pre-wired cable (2 m) | | Approx. 120 g | | | Approx. 65 g | | | | |
| | Connector | | Approx. 30 g | | | Approx. 20 g | | | | |
| Material | Case | | PBT (polybutylene terephthalate) | | | | | | | |
| | Lens | | Modified polyarylate | | | Methacrylic resin | Modified polyarylate | | | |

| Item | Sensing method | | Retro-reflective for clear, plastic bottles (without MSR function) | | | |
|---------------------------|-----------------------|------------|---|------------------------|--|------------------------------------|
| | Model | | E3Z-B61 | E3Z-B66 | E3Z-B62 | E3Z-B67 |
| | NPN output | | E3Z-B61 | E3Z-B66 | E3Z-B62 | E3Z-B67 |
| | | PNP output | E3Z-B81 | E3Z-B86 | E3Z-B82 | E3Z-B87 |
| Sensing distance | | | 500 mm (80 mm) *1 (using E39-R1S) | | | 2 m (500 mm) *1 *2 (using E39-R1S) |
| Standard sensing object | | | 500-ml (65-mm dia.) transparent round plastic bottles | | | |
| Light source (wavelength) | | | Red LED (660 nm) | | | |
| Current consumption | | | 30 mA max. | | | |
| Protection circuits | | | Reversed power supply polarity protection, Output short-circuit protection, Mutual interference prevention, and Reversed output polarity protection | | | |
| Response time | | | Operate or reset: 1 ms max. | | | |
| Degree of protection | | | IEC, IP67 | | | |
| Connection method | | | Pre-wired cable (standard length: 2 m and 0.5 m) | Connector (M8, 4 pins) | Pre-wired cable (standard length: 2 m and 0.5 m) | Connector (M8, 4 pins) |
| Weight (packed state) | Pre-wired cable (2 m) | | Approx. 65 g | | | |
| | Standard Connector | | Approx. 20 g | | | |
| Material | Case | | PBT (polybutylene terephthalate) | | | |
| | Lens | | Modified polyarylate | | | |

*1. Values in parentheses indicate the minimum required distances between the Sensors and Reflectors.

*2. Plastic bottles must pass with the minimum clearance of 500 mm.

The E3Z-T□2-G0 is equipped with an emission stop function. Ratings and specifications of this function are given in the following table.

| Item | Sensing method Output and Modes | Through-beam models, NPN output: E3Z-T62/T67-G0, PNP output: E3Z-T82/T87-G0 |
|------------------------|------------------------------------|---|
| Emission stop function | Input | <NPN models> Emission OFF: Short-circuit to 0 V or 1.5 V max. (Outflow current 1 mA max.), Emission ON: Disconnected (Leakage current 0.1 mA max.) <PNP models> Emission OFF: Short-circuit to +DC (Power supply plus side) or +DC-1.5 V max. (Inlet current 3 mA max.), Emission ON: Disconnected (Leakage current 0.1 mA max.) |
| | Response time | Operate or reset: 0.5 ms max. |

Visible spot models are available for through-beam NPN output models. The different items from E3Z-T62 are listed below.

| | |
|---------------------------|--|
| Model | E3Z-T62-SOSDW-P2 |
| Light source (wavelength) | Orange LED (615 nm) |
| Response time | Operate or reset: 1 ms max. |
| Connection method | Pre-wired cable (Standard length: 2 m) |

| Item | Sensing method Model | Transparent glass Limited-reflective (for transparent object detection) | |
|-------------------------------------|-------------------------|---|--------------|
| | | NPN output | PNP output |
| | | E3Z-L63 | E3Z-L68 |
| | | E3Z-L83 | E3Z-L88 |
| Sensing distance | | 30±20 mm (transparent glasses 100 × 100 mm) | |
| Spot diameter | | 2-mm dia. min. (at sensing distance of 30 mm) | |
| Minimum detectable object (typical) | | 0.1 mm dia. (copper wire) | |
| Light source (wavelength) | | Red LED (660 nm) | |
| Current consumption | | 30 mA max. | |
| Protection circuits | | Power supply reverse polarity protection, Output short-circuit protection, Mutual interference prevention, Reverse output polarity protection | |
| Response time | | Operate or reset: 1 ms max. | |
| Degree of protection | | IEC, IP67 | |
| Connection method | | Pre-wired (standard length: 2 m) | M8 connector |
| Weight (packed state) | Pre-wired cable (2 m) | Approx. 65 g | |
| | Standard Connector | Approx. 20 g | |
| Material | Case | PBT (polybutylene terephthalate) | |
| | Lens | Modified polyarylate | |

Oil-resistant

| Item | Model | Sensing method | | Through-beam | Retro-reflective | Diffuse-reflective | |
|----------------------------------|-------------------------------|------------------------|------------------|---|---|---------------------------------------|------------------------------------|
| | | NPN out-put | Pre-wired Models | E3Z-T61K | E3Z-R61K | E3Z-D61K | E3Z-D62K |
| | | M8 Pre-wired connector | | E3Z-T61K-M3J | E3Z-R61K-M3J | E3Z-D61K-M3J | E3Z-D62K-M3J |
| | | PNP out-put | Pre-wired Models | E3Z-T81K | E3Z-R81K | E3Z-D81K | E3Z-D82K |
| | | M8 Pre-wired connector | | E3Z-T81K-M3J | E3Z-R81K-M3J | E3Z-D81K-M3J | E3Z-D82K-M3J |
| Sensing distance | | | | 15 m | 3 m (150 mm) * (when using E39-R1S) 2 m (100 mm) * (when using E39-R1) | 100 mm (white paper: 100 × 100 mm) | 1 m (white paper: 300 × 300 mm) |
| Standard sensing object | | | | Opaque: 12-mm dia. min. | Opaque: 75-mm dia. min. | --- | |
| Differential travel | | | | --- | | 20% max. of setting distance | |
| Directional angle | | | | Both emitter and receiver: 3 to 15° | 2 to 10° | --- | |
| Light source (wavelength) | | | | Infrared LED (870 nm) | Red LED (660 nm) | Infrared LED (860 nm) | |
| Current consumption | | | | 35 mA max. (Emitter: 15 mA max., Receiver: 20 mA max.) | 30 mA max. | | |
| Protection circuits | | | | Reversed power supply polarity protection, Output short-circuit protection, and Reversed output polarity protection | Reversed power supply polarity protection, Output short-circuit protection, Mutual interference prevention, and Reversed output polarity protection | | |
| Response time | | | | Operate or reset: 1 ms max. | | | |
| Degree of protection | | | | IP67 (IEC), Oil resistant models: IP67 (IEC) (in-house standards: oilproof), excluding cables and connectors | | | |
| Connection method | | | | Pre-wired cable (standard length: 2 m), M8 Pre-wired Connector | | | |
| Weight (packed state) | Pre-wired cable (2 m) | | | Approx. 120 g | Approx. 65 g | | |
| | Connector (M8, 4 pins) | | | Approx. 50 g | Approx. 30 g | | |
| Material | Case | | | PBT (polybutylene terephthalate) | | | |
| | Lens | | | Modified polyarylate | Methacrylic resin | Modified polyarylate | |

* Values in parentheses indicate the minimum required distance between the Sensor and Reflector.

Common

| | |
|---|---|
| Power supply voltage | 12 to 24 VDC±10%, ripple (p-p): 10% max. |
| Control output | Load power supply voltage: 26.4 VDC max., Load current: 100 mA max. Residual voltage: Load current of less than 10 mA: 1 V max. Load current of 10 to 100 mA: 2 V max. Open collector output (NPN/PNP depending on model) Light-ON/Dark-ON selectable |
| Sensitivity adjustment | One-turn adjuster |
| Ambient illumination (Receiver side) | Incandescent lamp: 3,000 lx max. Sunlight: 10,000 lx max. |
| Ambient temperature range | Operating: -25 to 55°C, Some connector models: -40°C to 55°C * (with no icing or condensation) Storage: -40 to 70°C (with no icing or condensation) |
| Ambient humidity range | Operating: 35% to 85%, Storage: 35% to 95% (with no condensation) |
| Insulation resistance | 20 MΩ min. at 500 VDC |
| Dielectric strength | 1,000 VAC, 50/60 Hz for 1 min |
| Vibration resistance | Destruction: 10 to 55 Hz, 1.5 mm double amplitude for 2 hours each in X, Y, and Z directions |
| Shock resistance | Destruction: 500 m/s ² 3 times each in X, Y, and Z directions |
| Indicator | Operation indicator (orange) Stability indicator (green) Through-beam Emitter has power indicator (orange) only. |
| Accessories | Instruction manual (Neither Reflectors nor Mounting Brackets are provided with any of the above models.) |

* The ambient temperature range during operation for connector models depends on the model. For the E3Z-T66/T86/R66/R86, the range is -40°C to 55°C. For the E3Z-D66/D86/D67/D87, the range is -30°C to 55°C. For other connector models, the range is -25°C to -55°C.
The sensing distance for Retro-reflective Models (E3Z-R66/R86) between -40°C to -25°C, however, will be as follows (not the values in the table):
With E39-R1S: 3 m (100 mm), With E39-R1: 2 m (100 mm).
Also, use the XS3F-M42□-4□□-L Sensor I/O Connector (PUR cable) for applications between -25°C to -40°C. (Refer to page 6.)

Engineering Data (Typical)

Parallel Operating Range

Through-beam Models

E3Z-T□1(T□6)



Through-beam Models

E3Z-T□1(T□6) and Slit

(A Slit is mounted to the Emitter and Receiver.)

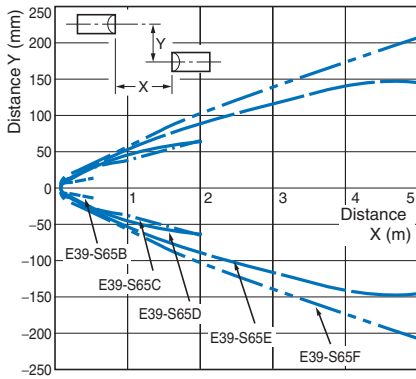

E3Z-B□1/B□6 + E39-R1S Reflector (Order Separately)

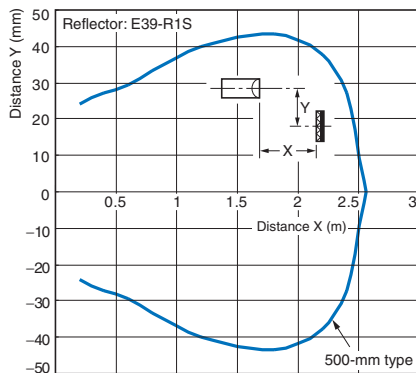

Through-beam Models

E3Z-T□A

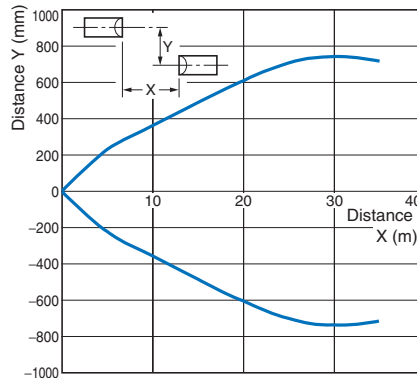

Through-beam Models

E3Z-T□A and Slit

(A Slit is mounted to the Emitter and Receiver.)

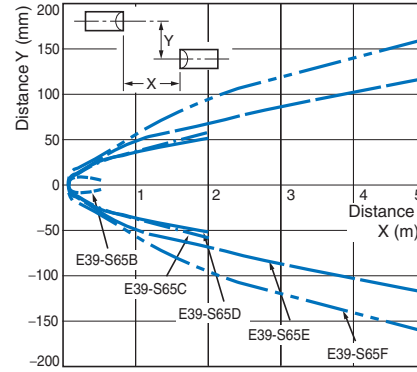

E3Z-B□2/B□7 + E39-R1S

Reflector (Order Separately)

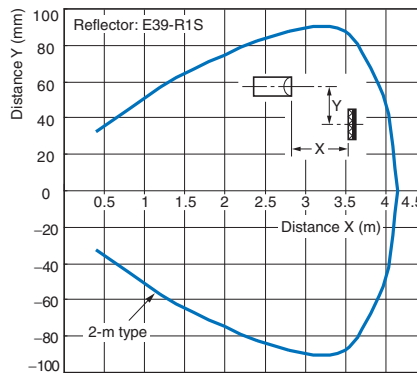

Through-beam Models

E3Z-T□2(T□7)

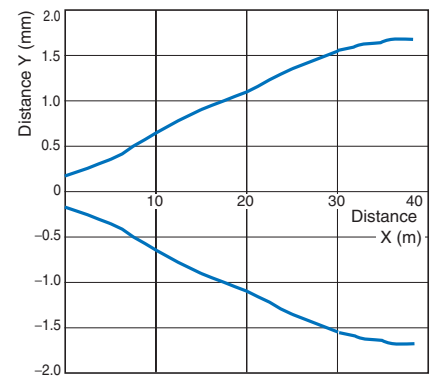

Retro-reflective Models

E3Z-R□1(R□6) and Reflector

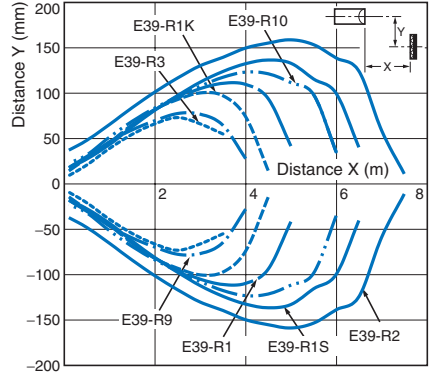

Operating Range

Diffuse-reflective Models

E3Z-D□1(D□6)



Diffuse-reflective Models

E3Z-D□2(D□7)



Narrow-beam Reflective Models

E3Z-L□1(L□6)



Excess Gain vs. Set Distance

Through-beam Models

E3Z-T□1(T□6)/-T□A/-T□2(T□7)



Retro-reflective Models

E3Z-R□1(R□6) and Reflector



Diffuse-reflective Models

E3Z-D□1(D□6)



Diffuse-reflective Models

E3Z-D□2(D□7)



Narrow-beam Reflective Models

E3Z-L□1(L□6)

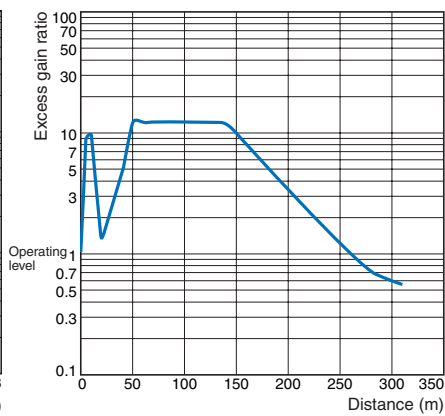

Limited reflective Models

E3Z-L□3(L□8)



Excess Gain vs. Set Distance

E3Z-B□1/B□6 + E39-R1S Reflector (Order Separately)



E3Z-B□2/B□7 + E39-R1S Reflector (Order Separately)



Sensing Object Size vs. Sensing Distance

Diffuse-reflective Models

E3Z-D□1(D□6)



Diffuse-reflective Models

E3Z-D□2(D□7)



Narrow-beam Reflective Models

E3Z-L□1(L□6)



Spot Diameter vs. Sensing Distance

Narrow-beam Reflective Models

E3Z-L□1(L□6)



Differential Travel vs. Sensing Distance

Narrow-beam Reflective Models

E3Z-L□1(L□6)



I/O Circuit Diagrams

NPN Output

| Model* | Operation mode | Timing charts | Operation selector | Output circuit | | | | | | |
|--|----------------|--|--------------------|--|--|------------------|--|--|-----|---|
| E3Z-T61(K) E3Z-T66 E3Z-T62 E3Z-T67 E3Z-T61A E3Z-T66A E3Z-R61(K) E3Z-R66 E3Z-D61(K) E3Z-D66 E3Z-D62(K) E3Z-D67 E3Z-L61 E3Z-L66 E3Z-B61 E3Z-B66 E3Z-B62 E3Z-B67 E3Z-L63 E3Z-L68 | Light-ON | Incident light No incident light Operation indicator (orange) ON OFF Output transistor ON OFF Load Operate (e.g., relay) Reset (Between brown (1) and black (4) leads) | L side (LIGHT ON) | Through-beam Receivers, Retro-reflective Models, Diffuse-reflective Models, Limited reflective Models. Connector Pin Arrangement e-CON Connector Pin Arrangement Pin 2 is not used. | | | | | | |
| | | Dark-ON | | | Incident light No incident light Operation indicator (orange) ON OFF Output transistor ON OFF Load Operate (e.g., relay) Reset (Between brown (1) and black (4) leads) | D side (DARK ON) | | | | |
| | | | | | Through-beam Emitter | | Connector Pin Arrangement e-CON Connector Pin Arrangement Pins 2 and 4 are not used. | | | |
| | | | | | E3Z-T62-G0 E3Z-T67-G0 | | --- | Emission stop input ON OFF (Between blue (3) and pink (2) leads) LED for emission ON OFF Indicator (orange) ON OFF | --- | Through-beam Emitter Connector Pin Arrangement Pin 4 is not used. |

PNP Output

| Model* | Operation mode | Timing charts | Operation selector | Output circuit | | | | | | |
|--|----------------|---|--------------------|---|---|------------------|---|---|-----|---|
| E3Z-T81(K) E3Z-T86 E3Z-T82 E3Z-T87 E3Z-T81A E3Z-T86A E3Z-R81(K) E3Z-R86 E3Z-D81(K) E3Z-D86 E3Z-D82(K) E3Z-D87 E3Z-L81 E3Z-L86 E3Z-B81 E3Z-B86 E3Z-B82 E3Z-B87 E3Z-L83 E3Z-L88 | Light-ON | Incident light No incident light Operation indicator (orange) ON OFF Output transistor ON OFF Load Operate (e.g., relay) Reset (Between blue (3) and black (4) leads) | L side (LIGHT ON) | Through-beam Receivers, Retro-reflective Models, Diffuse-reflective Models, Limited reflective Models. Connector Pin Arrangement Pin 2 is not used. | | | | | | |
| | | Dark-ON | | | Incident light No incident light Operation indicator (orange) ON OFF Output transistor ON OFF Load Operate (e.g., relay) Reset (Between blue (3) and black (4) leads) | D side (DARK ON) | | | | |
| | | | | | Through-beam Emitter | | Connector Pin Arrangement Pins 2 and 4 are not used. | | | |
| | | | | | E3Z-T82-G0 E3Z-T87-G0 | | --- | Emission stop input ON OFF (Between brown (1) and pink (2) leads) LED for emission ON OFF Indicator (orange) ON OFF | --- | Through-beam Emitter Connector Pin Arrangement Pin 4 is not used. |

* Models numbers for Through-beam Sensors (E3Z-T□□) are for sets that include both the Emitter and Receiver. The model number of the Emitter is expressed by adding "L" to the set model number (example: E3Z-T61-L 2M), the model number of the Receiver, by adding "-D" (example: E3Z-T61-D 2M.) Refer to *Ordering Information* to confirm model numbers for Emitter and Receivers.

Plugs (Sensor I/O Connectors)

M8 connector



e-CON connector



Pin arrangement

| Classification | Wire color | Connector pin No. | Application |
|----------------|------------|-------------------|-----------------------|
| DC | Brown | 1 | Power supply (+V) |
| | White | 2 | (Emission stop input) |
| | Blue | 3 | Power supply (0 V) |
| | Black | 4 | Output |

Note: Pin 2 is not used.

Nomenclature

Through-beam Models

E3Z-T□□ (Emitter)

E3Z-T□□A (Receiver)

Retro-reflective Models

E3Z-R□□

E3Z-B□□

Diffuse-reflective Models

E3Z-D□□

Narrow-beam Reflective Models

E3Z-L□□

Limited reflective Models

E3Z-L□□



Safety Precautions

Refer to *Warranty and Limitations of Liability*.

⚠ WARNING

This product is not designed or rated for ensuring safety of persons either directly or indirectly. Do not use it for such purposes.



Precautions for Correct Use

Do not use the product in atmospheres or environments that exceed product ratings.

● **Wiring**

M8 Metal Connector

- Be sure to connect or disconnect the metal connector after turning OFF the Sensor.
- Hold the connector cover to connect or disconnect the metal connector.
- Secure the connector cover by hand. Do not use any pliers, otherwise the connector may be damaged.
- The proper tightening torque range is between 0.3 and 0.4 N·m. Be sure to tighten the connector securely, otherwise the specified degree of protection may not be maintained or the connector may be disconnected due to vibration.

● **Mounting**

Sensor Mounting

Use M3 screws to mount the sensor and tighten each screw to a maximum torque of 0.53 N·m.

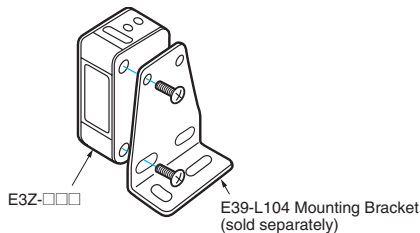

● **Oil-resistant Models**

Oil Resistance

- Although the E3Z-□□□K Sensors have oil-resistant specifications, performance may be affected by certain types of oil. Refer to the following table.
- E3Z-□□□K Sensors are tested for resistance to the oils given in the following table. Refer to the information in the table when deciding which type of oil to use.

| Test oil classification | Product name | Kinematic viscosity (mm ² /s) at 40°C | pH |
|-------------------------------|----------------------|--|----------|
| Lubricant | Velocity No.3 | 2.02 | --- |
| Water insoluble machining oil | Yushiron Oil No.2 ac | Less than 10 | |
| Water soluble machining oil | Yushiroken EC50T-3 | --- | 7 to 9.5 |
| | Yushiron Lubic HWC68 | | 7 to 9.9 |
| | Gryton 1700D | | 7 to 9.2 |
| | Yushironken S50N | | 7 to 9.8 |

Note: 1. The E3Z maintained a minimum insulation resistance of 100 MΩ after it was dipped in all the above oils for 240 hours.
 2. When using the Sensors in environments subject to oils other than those listed above, use the figures for kinematic viscosity and pH from the table as general guidelines. Additives and other substances contained in oils may affect the E3Z. Be sure to consider this before use.

Dimensions

Tolerance class IT16 applies to dimensions in this data sheet unless otherwise specified.

Sensors

Through-beam*
Pre-wired Models
E3Z-T61(K)
E3Z-T81(K)
E3Z-T61A
E3Z-T81A
E3Z-T62(-G0)
E3Z-T82(-G0)

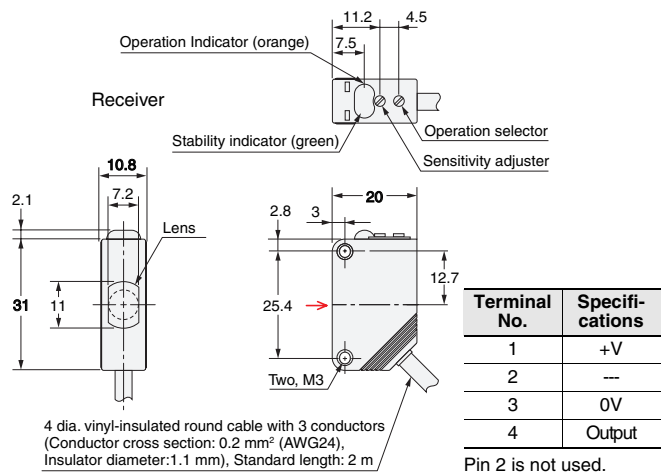
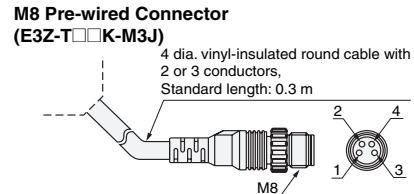
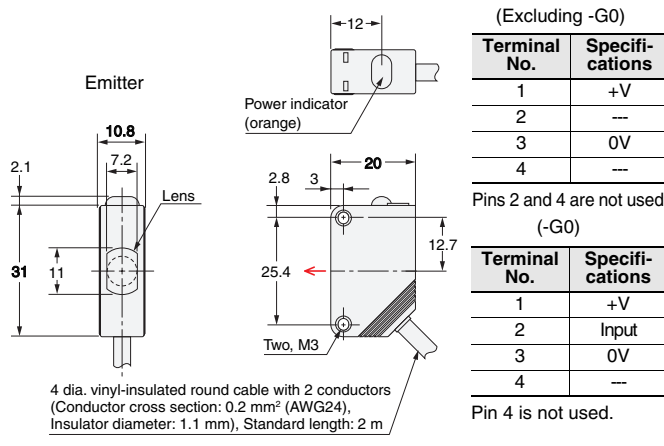

* The Emitter cable has two conductors and the Receiver cable has three conductors.

Through-beam*
Connector Models
E3Z-T66
E3Z-T86
E3Z-T66A
E3Z-T86A
E3Z-T67(-G0)
E3Z-T87(-G0)

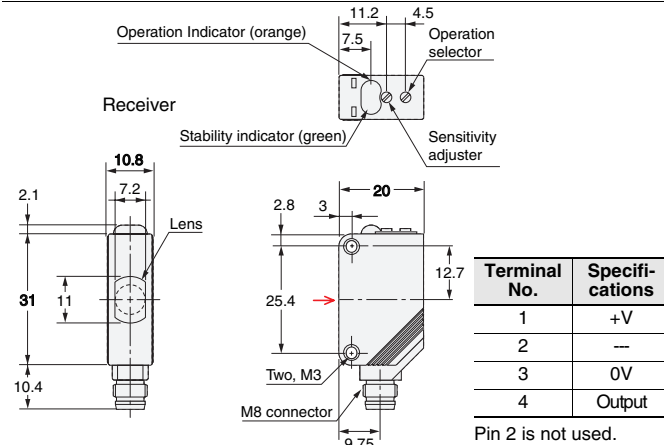
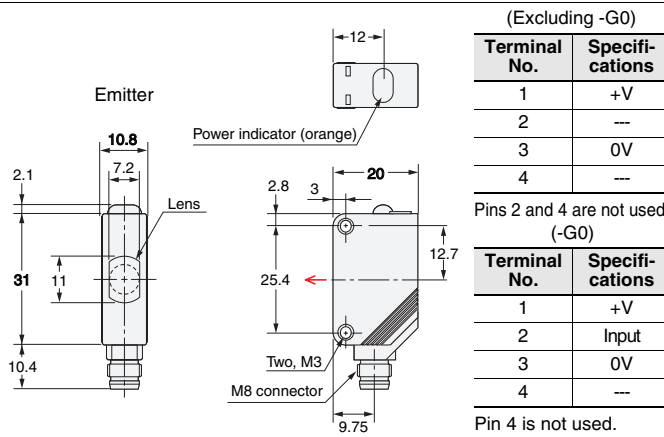

* Models numbers for Through-beam Sensors (E3Z-T□□) are for sets that include both the Emitter and Receiver. The model number of the Emitter is expressed by adding "-L" to the set model number (example: E3Z-T61-L 2M), the model number of the Receiver, by adding "-D" (example: E3Z-T61-D 2M). Refer to *Ordering Information* to confirm model numbers for Emitter and Receivers.

Retro-reflective Models

Pre-wired Models

- E3Z-R61(K) E3Z-B61
- E3Z-R81(K) E3Z-B81
- E3Z-D61(K) E3Z-B62
- E3Z-D81(K) E3Z-B82
- E3Z-D62(K) E3Z-L63
- E3Z-D82(K) E3Z-L83
- E3Z-L61
- E3Z-L81



| Terminal No. | Specifications |
|--------------|----------------|
| 1 | +V |
| 2 | --- |
| 3 | 0V |
| 4 | Output |

M12 Pre-wired Connector (E3Z-□□□-M1J)



M8 Pre-wired Connector (E3Z-T□□K-M3J)



Press-fit e-CON Pre-wired Connector



Clamp-type e-CON pre-wired connectors (E3Z-□6□-ECON-C)



Retro-reflective Models

Connector Models

- E3Z-R66 E3Z-B66
- E3Z-R86 E3Z-B86
- E3Z-D66 E3Z-B67
- E3Z-D86 E3Z-B87
- E3Z-D67 E3Z-L68
- E3Z-D87 E3Z-L88
- E3Z-L66
- E3Z-L86



| Terminal No. | Specifications |
|--------------|----------------|
| 1 | +V |
| 2 | --- |
| 3 | 0V |
| 4 | Output |

Note: The lens for the E3Z-D□1/D□6/L□□/B□□ is red. The lens for the E3Z-D□2/D□7 is black.

e-CON Connector Configurations

| Wiring method | Sensor connectors |
|---------------|--|
| Press-fit | 37104-3122-000FL (made by Sumitomo 3M) |
| Clamp | XN2A-1430 (made by OMRON) |

Accessories (Order Separately)

Slits

E39-S65A
E39-S65B
E39-S65C



| Model | Size A | Material |
|----------|----------|------------------------|
| E39-S65A | 0.5 dia. | SUS301 stainless steel |
| E39-S65B | 1.0 dia. | |
| E39-S65C | 2.0 dia. | |

Slits

E39-S65D
E39-S65E
E39-S65F



| Model | Size A | Material |
|----------|--------|------------------------|
| E39-S65D | 0.5 | SUS301 stainless steel |
| E39-S65E | 1.0 | |
| E39-S65F | 2.0 | |

Slits

E39-L44

(Mounting dimensions)



Slits

E39-L104

(Mounting dimensions)



Mounting Brackets

Refer to E39-R for details.

Sensor I/O Connectors

Refer to XS2□ and XS3□ for details.

Read and Understand This Catalog

Please read and understand this catalog before purchasing the products. Please consult your OMRON representative if you have any questions or comments.

Warranty and Limitations of Liability

WARRANTY

OMRON's exclusive warranty is that the products are free from defects in materials and workmanship for a period of one year (or other period if specified) from date of sale by OMRON.

OMRON MAKES NO WARRANTY OR REPRESENTATION, EXPRESS OR IMPLIED, REGARDING NON-INFRINGEMENT, MERCHANTABILITY, OR FITNESS FOR PARTICULAR PURPOSE OF THE PRODUCTS. ANY BUYER OR USER ACKNOWLEDGES THAT THE BUYER OR USER ALONE HAS DETERMINED THAT THE PRODUCTS WILL SUITABLY MEET THE REQUIREMENTS OF THEIR INTENDED USE. OMRON DISCLAIMS ALL OTHER WARRANTIES, EXPRESS OR IMPLIED.

LIMITATIONS OF LIABILITY

OMRON SHALL NOT BE RESPONSIBLE FOR SPECIAL, INDIRECT, OR CONSEQUENTIAL DAMAGES, LOSS OF PROFITS OR COMMERCIAL LOSS IN ANY WAY CONNECTED WITH THE PRODUCTS, WHETHER SUCH CLAIM IS BASED ON CONTRACT, WARRANTY, NEGLIGENCE, OR STRICT LIABILITY.

In no event shall the responsibility of OMRON for any act exceed the individual price of the product on which liability is asserted.

IN NO EVENT SHALL OMRON BE RESPONSIBLE FOR WARRANTY, REPAIR, OR OTHER CLAIMS REGARDING THE PRODUCTS UNLESS OMRON'S ANALYSIS CONFIRMS THAT THE PRODUCTS WERE PROPERLY HANDLED, STORED, INSTALLED, AND MAINTAINED AND NOT SUBJECT TO CONTAMINATION, ABUSE, MISUSE, OR INAPPROPRIATE MODIFICATION OR REPAIR.

Application Considerations

SUITABILITY FOR USE

OMRON shall not be responsible for conformity with any standards, codes, or regulations that apply to the combination of products in the customer's application or use of the products.

At the customer's request, OMRON will provide applicable third party certification documents identifying ratings and limitations of use that apply to the products. This information by itself is not sufficient for a complete determination of the suitability of the products in combination with the end product, machine, system, or other application or use.

The following are some examples of applications for which particular attention must be given. This is not intended to be an exhaustive list of all possible uses of the products, nor is it intended to imply that the uses listed may be suitable for the products:

- Outdoor use, uses involving potential chemical contamination or electrical interference, or conditions or uses not described in this catalog.
- Nuclear energy control systems, combustion systems, railroad systems, aviation systems, medical equipment, amusement machines, vehicles, safety equipment, and installations subject to separate industry or government regulations.
- Systems, machines, and equipment that could present a risk to life or property.

Please know and observe all prohibitions of use applicable to the products.

NEVER USE THE PRODUCTS FOR AN APPLICATION INVOLVING SERIOUS RISK TO LIFE OR PROPERTY WITHOUT ENSURING THAT THE SYSTEM AS A WHOLE HAS BEEN DESIGNED TO ADDRESS THE RISKS, AND THAT THE OMRON PRODUCTS ARE PROPERLY RATED AND INSTALLED FOR THE INTENDED USE WITHIN THE OVERALL EQUIPMENT OR SYSTEM.

PROGRAMMABLE PRODUCTS

OMRON shall not be responsible for the user's programming of a programmable product, or any consequence thereof.

Disclaimers

CHANGE IN SPECIFICATIONS

Product specifications and accessories may be changed at any time based on improvements and other reasons.

It is our practice to change model numbers when published ratings or features are changed, or when significant construction changes are made. However, some specifications of the products may be changed without any notice. When in doubt, special model numbers may be assigned to fix or establish key specifications for your application on your request. Please consult with your OMRON representative at any time to confirm actual specifications of purchased products.

DIMENSIONS AND WEIGHTS

Dimensions and weights are nominal and are not to be used for manufacturing purposes, even when tolerances are shown.

PERFORMANCE DATA

Performance data given in this catalog is provided as a guide for the user in determining suitability and does not constitute a warranty. It may represent the result of OMRON's test conditions, and the users must correlate it to actual application requirements. Actual performance is subject to the OMRON Warranty and Limitations of Liability.

ERRORS AND OMISSIONS

The information in this document has been carefully checked and is believed to be accurate; however, no responsibility is assumed for clerical, typographical, or proofreading errors, or omissions.

2011.8

In the interest of product improvement, specifications are subject to change without notice.

OMRON Corporation
Industrial Automation Company

<http://www.ia.omron.com/>

(c)Copyright OMRON Corporation 2011 All Right Reserved.

Данный компонент на территории Российской Федерации

Вы можете приобрести в компании MosChip.

Для оперативного оформления запроса Вам необходимо перейти по данной ссылке:

<http://moschip.ru/get-element>

Вы можете разместить у нас заказ для любого Вашего проекта, будь то серийное производство или разработка единичного прибора.

В нашем ассортименте представлены ведущие мировые производители активных и пассивных электронных компонентов.

Нашей специализацией является поставка электронной компонентной базы двойного назначения, продукции таких производителей как XILINX, Intel (ex.ALTERA), Vicor, Microchip, Texas Instruments, Analog Devices, Mini-Circuits, Amphenol, Glenair.

Сотрудничество с глобальными дистрибьюторами электронных компонентов, предоставляет возможность заказывать и получать с международных складов практически любой перечень компонентов в оптимальные для Вас сроки.

На всех этапах разработки и производства наши партнеры могут получить квалифицированную поддержку опытных инженеров.

Система менеджмента качества компании отвечает требованиям в соответствии с ГОСТ Р ИСО 9001, ГОСТ РВ 0015-002 и ЭС РД 009

Офис по работе с юридическими лицами:

105318, г.Москва, ул.Щербаковская д.3, офис 1107, 1118, ДЦ «Щербаковский»

Телефон: +7 495 668-12-70 (многоканальный)

Факс: +7 495 668-12-70 (доб.304)

E-mail: info@moschip.ru

Skype отдела продаж:

moschip.ru

moschip.ru_4

moschip.ru_6

moschip.ru_9