

Insulated Shaft Potentiometer 12mm Size Insulated Shaft Snap-in Type

RK12L Series



High performance 12mm width type.

Rotary Potentiometers

Slide Potentiometers

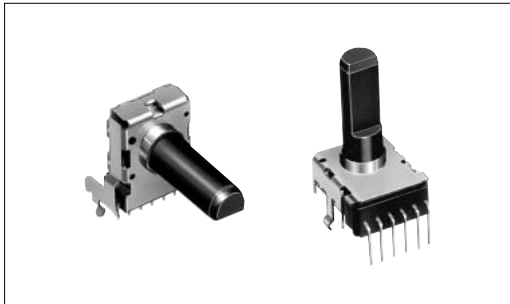

Typical Specifications

Items	Specifications
Total resistance tolerance	± 20%
Maximum operating voltage	50V AC for AC only
Total rotational angle	300 ± 5 °
Rotational torque	2 to 15mN·m
Operating life	15,000cycles
Operating temperature range	- 10 to + 70

Metal Shaft

Insulated Shaft

Knob Operating

Product Line

Number of resistor elements	Mounting direction	Shaft type	Length of the shaft LM.(mm)	Center detent	Total resistance (k)	Resistance taper	Application	Minimum order unit (pcs.)	Products No.	Drawing No.	
Dual-unit	Vertical type	Flat	20	Without	50	1B	For tone	1,000	RK12L1230C0K	2	
			30		10	15A					
			25	With	20	1B		800	RK12L1230C1M		
			30		50						
	Horizontal type		30	Without	10	15A	For vol.	1,200	RK12L1210C0R	1	
	Vertical type		15		50	15C					
			25		10	15A			800	RK12L12C0A0E	2
			30		20					RK12L12C0A0G	
		10			RK12L12C0A0A						
	Horizontal type	30	10		RK12L12A0C0R					1	

Note

Products other than those listed in above products are also available. Please contact us for details.

Refer to P.379 for product varieties.

Dimensions

Unit:mm

No.	Photo	Style	PC board mounting hole dimensions (Viewed from mounting side)										
1	<p>Horizontal type without bushing RK12L121(For tone control) RK12L12A(For vol. control)</p>												
2	<p>Vertical type without bushing RK12L123(For tone control) RK12L12C(For vol. control)</p>	<table border="1"> <tr> <td>LM₁</td> <td>15</td> <td>20</td> <td>25</td> <td>30</td> </tr> <tr> <td>ℓ₁</td> <td>4.5</td> <td>7</td> <td>12</td> <td>12</td> </tr> </table>	LM ₁	15	20	25	30	ℓ ₁	4.5	7	12	12	
LM ₁	15	20	25	30									
ℓ ₁	4.5	7	12	12									

Rotary Potentiometers
Slide Potentiometers

Metal Shaft
Insulated Shaft
Knob Operating

Terminal Layout/Circuit Diagram

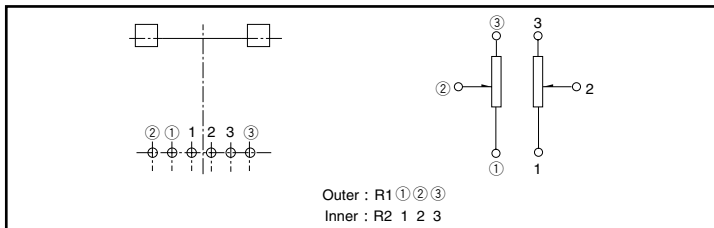

Product Varieties

In addition to the recommended products, the following specifications can also be accommodated.

Total Resistance Variety

Total resistance(k)	5	10	20	50	100	200
----------------------	---	----	----	----	-----	-----

Resistance Taper

Resistance taper	15A	1B	3B	15C
------------------	-----	----	----	-----

Shaft Variety

Unit:mm

Style	Vertical type		Horizontal type	
	LM ₁	15	20	25
ℓ ₁	4.5	7	12	12

Note

marked are specifications recommended by ALPS.

Refer to P.380, 502 for resistance taper.

Orders Other Than Recommended Products

When ordering product varieties that are not listed in the Product Line, please specify by referring to the below example.

Sample Part Number



Model type

Code	Model type
1	Horizontal type for tone
3	Vertical type for tone
A	Horizontal type for vol.
C	Vertical type for vol.

Shaft type

Code	Shaft type
F	Flat

* Only available in flat format.

Length of the shaft (LM₁ X mm)

Code	Length of the shaft	Code	Length of the shaft
15	15	25	25
20	20	30	30

Detent

Code	Center detent
C0	Without
C1	With

Resistance taper

Code	Resistance taper	Code	Resistance taper
A	15A	C	15C
B	1B	V	3B

B: For tone & general (Model type : 1,3)
 V: For vol. (Model type : A,C)

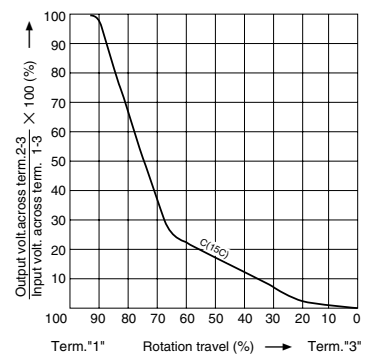
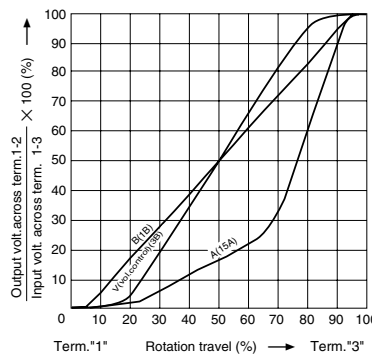

Total resistance

Code	Total resistance (kΩ)	Code	Total resistance (kΩ)
502	5	503	50
103	10	104	100
203	20	204	200





Note

marked are specifications recommended by ALPS.

Rotary Potentiometers
Slide Potentiometers

Metal Shaft
Insulated Shaft
Knob Operating

List of Varieties

Items	Type		9mm Size Insulated Shaft Snap-in	11mm Size Insulated Shaft Snap-in	12mm Size Insulated Shaft Snap-in	14mm Size Insulated Shaft Snap-in	9mm Size Insulated shaft Long-life	
	Model		RK09K11 RK09D11	RK09K12	RK11K11	RK12L12	RK14K12	RK09Y11L
			Single-unit	Dual-unit	Single-unit	Dual-unit		Single-unit
Photo								
Bushing		Without		With/Without	Without	With/Without	Without	
Electrical performance	Total resistance tolerance		± 20%	± 30%	± 20%		± 30%	
	Maximum operating voltage		50V AC 20V DC	50V AC For AC only	50V AC 20V DC	50V AC For AC only		50V AC 5V DC
	Insulation resistance		100M min. 250V DC		100M min. 500V DC	100M min. 250V DC		
	Voltage proof		250V AC for 1minute		500V AC for 1minute	300V AC for 1minute		250V AC for 1minute
	Gang error		—	- 40dB to 0dB 3dB max.	—	Volume control -40dB to 0dB 3dB max. For tone control within 2dB at center		—
Mechanical performance	Strength of the actuator	Stopper strength	0.3N·m		Without bushing 0.5N·m With bushing 0.6N·m	0.5N·m	0.6N·m	—
		Push-pull strength	50N max.		80N max.		30N max.	
	Vibration		10 to 55 to 10Hz/min., the amplitude is 1.5mm for all the frequencies, in the 3 direction of X, Y and Z and for 2 hours respectively					
	Resistance to soldering heat	Manual soldering	350 max. 3s max.					
		Dip Soldering	—			260 max. 5s max.	—	
Environmental performance	Cold		- 30 ± 2 for 96h				- 30 ± 2 for 240h	
	Dry heat		70 ± 2 for 96h		70 ± 2 for 240h	70 ± 2 for 96h	70 ± 2 for 240h	
	Damp heat		40 ± 2 , 90 to 95% RH for 96h				40 , 90 to 95% RH for 240h	
Page		368		374	378	381	385	

Rotary Potentiometers

Slide Potentiometers

Metal Shaft

Insulated Shaft

Knob Operating

Insulated Shaft Potentiometers Cautions386, 387

Данный компонент на территории Российской Федерации

Вы можете приобрести в компании MosChip.

Для оперативного оформления запроса Вам необходимо перейти по данной ссылке:

<http://moschip.ru/get-element>

Вы можете разместить у нас заказ для любого Вашего проекта, будь то серийное производство или разработка единичного прибора.

В нашем ассортименте представлены ведущие мировые производители активных и пассивных электронных компонентов.

Нашей специализацией является поставка электронной компонентной базы двойного назначения, продукции таких производителей как XILINX, Intel (ex.ALTERA), Vicor, Microchip, Texas Instruments, Analog Devices, Mini-Circuits, Amphenol, Glenair.

Сотрудничество с глобальными дистрибьюторами электронных компонентов, предоставляет возможность заказывать и получать с международных складов практически любой перечень компонентов в оптимальные для Вас сроки.

На всех этапах разработки и производства наши партнеры могут получить квалифицированную поддержку опытных инженеров.

Система менеджмента качества компании отвечает требованиям в соответствии с ГОСТ Р ИСО 9001, ГОСТ РВ 0015-002 и ЭС РД 009

Офис по работе с юридическими лицами:

105318, г.Москва, ул.Щербаковская д.3, офис 1107, 1118, ДЦ «Щербаковский»

Телефон: +7 495 668-12-70 (многоканальный)

Факс: +7 495 668-12-70 (доб.304)

E-mail: info@moschip.ru

Skype отдела продаж:

moschip.ru

moschip.ru_4

moschip.ru_6

moschip.ru_9