



## Technical Data Sheet

# 0.8mm Height Flat Top Infrared LED

### HIR19-21C/L11/TR8

#### Features

- High reliability
- Small double-end package
- Peak wavelength  $\lambda_p=850\text{nm}$
- Package in 8mm tape on 7" diameter reel
- Low forward voltage
- Pb free
- The product itself will remain within RoHS compliant version.

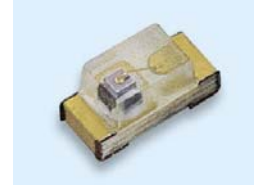

#### Descriptions

- HIR19-21C/L11/TR8 is an infrared emitting diode in miniature SMD package which is molded in a water clear plastic with flat top view lens.
- The device is spectrally matched with silicon photodiode and phototransistor.

#### Applications

- PCB mounted infrared sensor
- Infrared remote control units with high power requirement
- Smoke detector
- Infrared applied system

#### Device Selection Guide

LED Part No.	Chip	Lens Color
	Material	
HIR	GaAlAs	Water clear

**Package Dimensions**

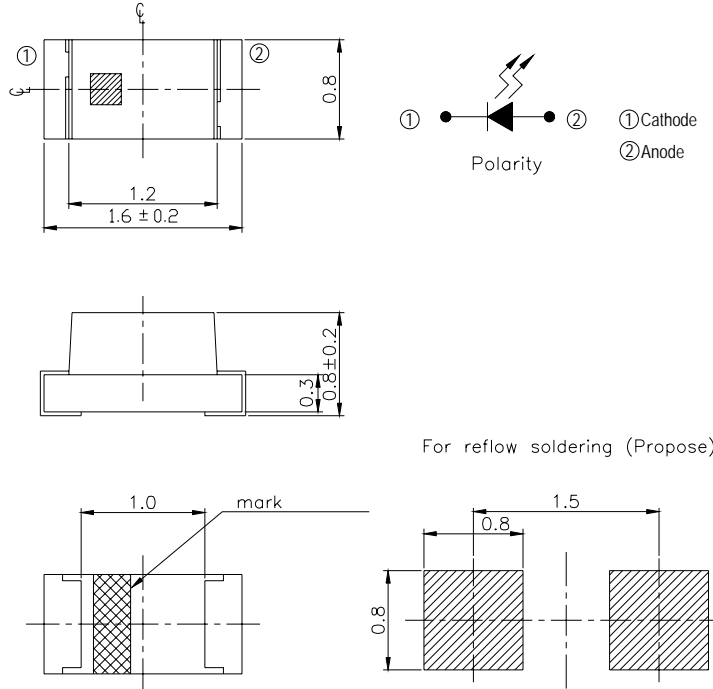

- Notes:** 1.All dimensions are in millimeters  
 2.Tolerances unless dimensions  $\pm 0.1$ mm

**Absolute Maximum Ratings (Ta=25°C)**

Parameter	Symbol	Rating	Units
Continuous Forward Current	$I_F$	65	mA
Peak Forward Current	$I_{FP}$	1.0	A
Reverse Voltage	$V_R$	5	V
Operating Temperature	$T_{opr}$	-25 ~ +85	°C
Storage Temperature	$T_{stg}$	-40 ~ +85	°C
Soldering Temperature	$T_{sol}$	260	°C
Power Dissipation at(or below) 25°C Free Air Temperature	$P_d$	130	mW

- Notes:** \*1: $I_{FP}$  Conditions--Pulse Width  $\leq 100 \mu s$  and Duty  $\leq 1\%$ .  
 \*2:Soldering time  $\leq 5$  seconds.

**Electro-Optical Characteristics (Ta=25°C)**

Parameter	Symbol	Condition	Min.	Typ.	Max.	Units
Radiant Intensity	Ee	I <sub>F</sub> =20mA	0.2	0.8	--	mW /sr
		I <sub>F</sub> =100mA Pulse Width ≤ 100 μs ,Duty ≤ 1%	--	4.2	--	
Peak Wavelength	λ <sub>p</sub>	I <sub>F</sub> =20mA	--	850	--	nm
Spectral Bandwidth	Δ λ	I <sub>F</sub> =50mA	--	45	--	nm
Forward Voltage	V <sub>F</sub>	I <sub>F</sub> =20mA	--	1.45	1.65	V
		I <sub>F</sub> =100mA Pulse Width ≤ 100 μs ,Duty ≤ 1%	--	1.80	2.40	
Reverse Current	I <sub>R</sub>	V <sub>R</sub> =5V	--	--	10	μ A
View Angle	2 θ 1/2	I <sub>F</sub> =20mA	--	145	--	deg

**Typical Electro-Optical Characteristics Curves**

Fig.1 Forward Current vs. Ambient Temperature

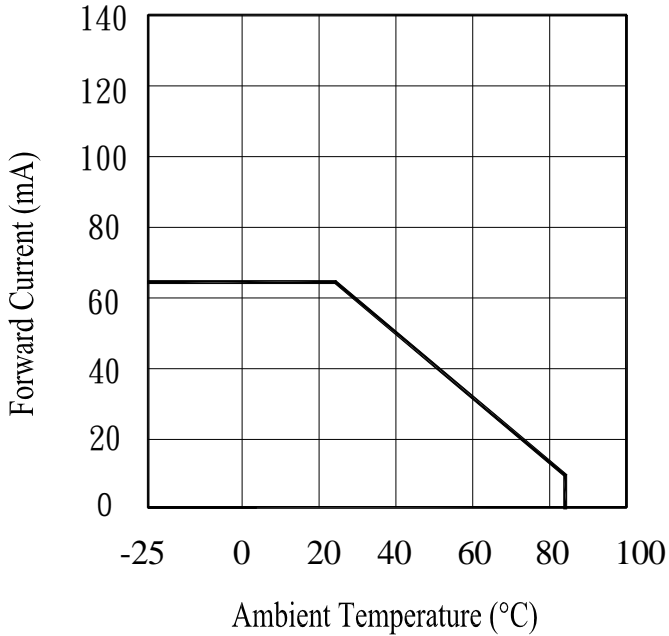

Fig.2 Spectral Distribution

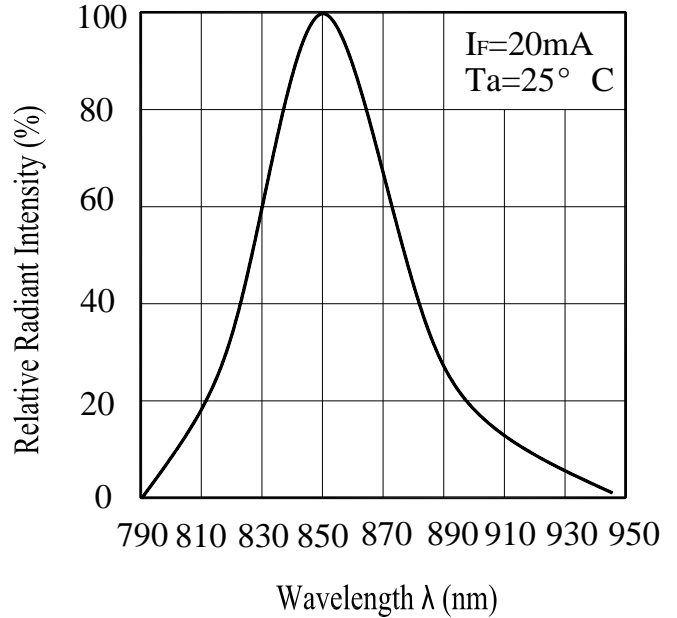

Fig.3 Peak Emission Wavelength vs. Ambient Temperature

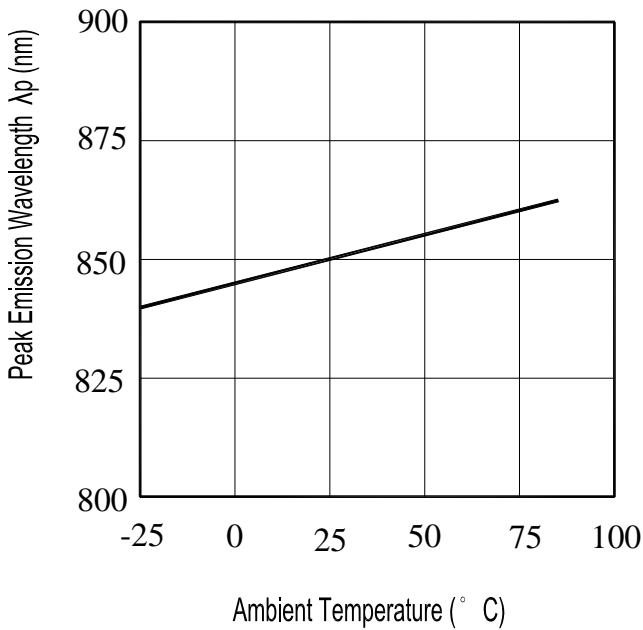
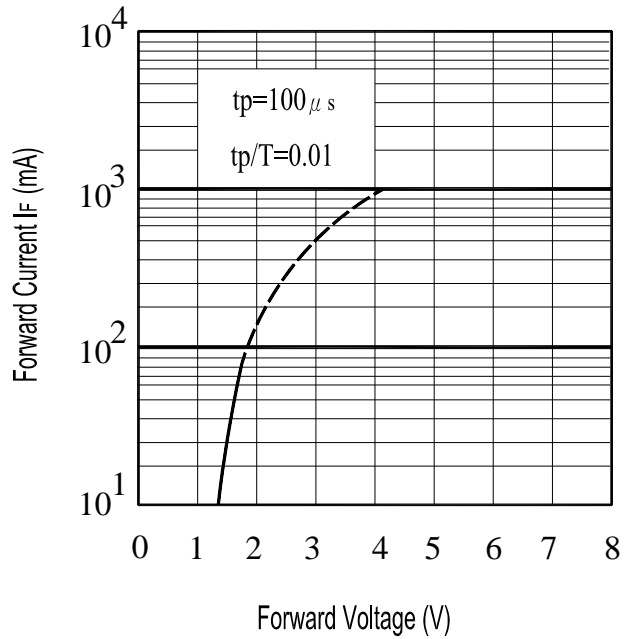

Fig.4 Forward Current vs. Forward Voltage



**Typical Electro-Optical Characteristics Curves**

Fig.5 Relative Intensity vs.  
Forward Current

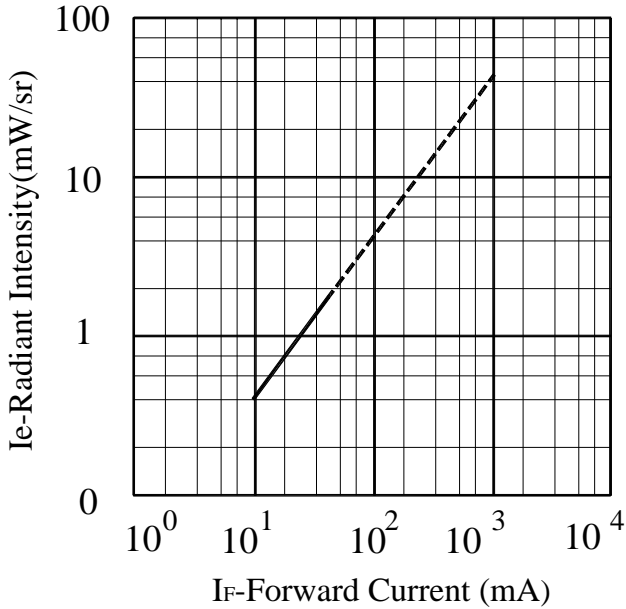

Fig.6 Relative Radiant Intensity vs.  
Angular Displacement

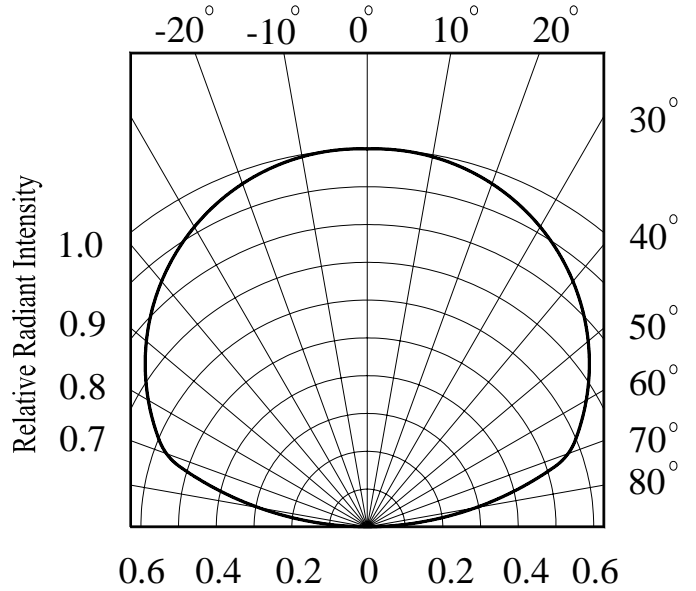

Fig.7 Relative Intensity vs.  
Ambient Temperature(°C)

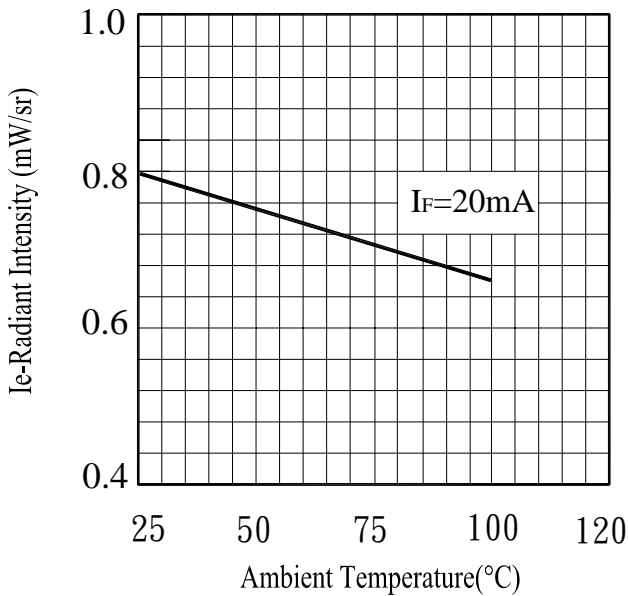
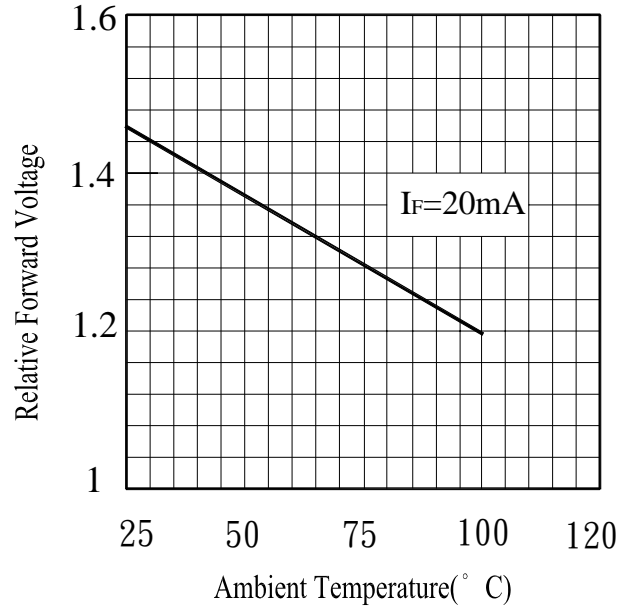

Fig.8 Forward Voltage vs.  
Ambient Temperature(°C)



## Precautions For Use

### 1. Over-current-proof

Customer must apply resistors for protection , otherwise slight voltage shift will cause big current change ( Burn out will happen ).

### 2. Storage

2.1 Do not open moisture proof bag before the products are ready to use.

2.2 Before opening the package, the LEDs should be kept at 30°C or less and 90%RH or less.

2.3 The LEDs should be used within a year.

2.4 After opening the package, the LEDs should be kept at 30°C or less and 70%RH or less.

2.5 The LEDs should be used within 168 hours (7 days) after opening the package.

2.6 If the moisture absorbent material (silica gel) has faded away or the LEDs have exceeded the storage time, baking treatment should be performed using the following conditions.

Baking treatment : 60±5°C for 24 hours.

### 3. Soldering Condition

#### 3.1 Pb-free solder temperature profile

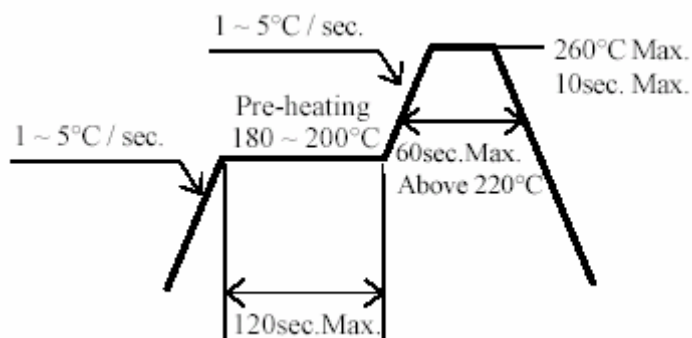

3.2 Reflow soldering should not be done more than two times.

3.3 When soldering, do not put stress on the LEDs during heating.

3.4 After soldering, do not warp the circuit board.

#### 4.Soldering Iron

Each terminal is to go to the tip of soldering iron temperature less than 280°C for 3 seconds within once in less than the soldering iron capacity 25W. Leave two seconds and more intervals, and do soldering of each terminal. Be careful because the damage of the product is often started at the time of the hand solder.

#### 5.Repairing

Repair should not be done after the LEDs have been soldered. When repairing is unavoidable, a double-head soldering iron should be used (as below figure). It should be confirmed beforehand whether the characteristics of the LEDs will or will not be damaged by repairing.



**Reliability Test Item And Condition**

The reliability of products shall be satisfied with items listed below.

Confidence level : 90%

LTPD : 10%

NO.	Item	Test Conditions	Test Hours/ Cycles	Sample Sizes	Failure Judgement Criteria	Ac/Re
1	REFLOW Soldering	TEMP. : 260°C±5°C 5secs	6Mins	22pcs	$I_R \geq U \times 2$	0/1
2	Temperature Cycle	H : +100°C    15mins ↑          5mins ↓          15mins L : -40°C	50Cycles	22pcs	$E_e \leq L \times 0.8$ $V_F \geq U \times 1.2$	0/1
3	Thermal Shock	H : +100°C    5mins ↑          10secs ↓          5mins L : -10°C	50Cycles	22pcs	U : Upper Specification Limit	0/1
4	High Temperature Storage	TEMP. : +100°C	1000hrs	22pcs	L : Lower Specification Limit	0/1
5	Low Temperature Storage	TEMP. : -40°C	1000hrs	22pcs		0/1
6	DC Operating Life	$I_F = 20\text{mA}$	1000hrs	22pcs		0/1
7	High Temperature/ High Humidity	85°C / 85% R.H	1000hrs	22pcs		0/1



**Package Dimensions**

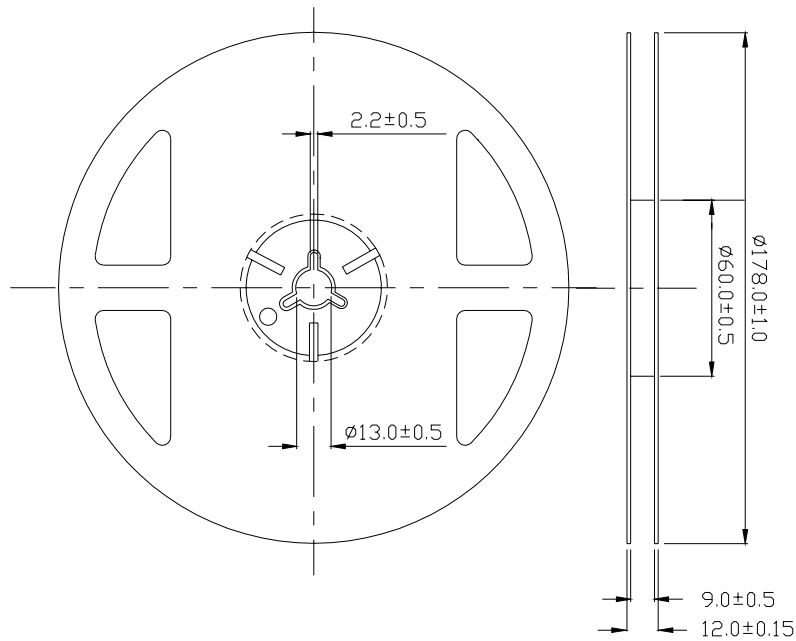

**Taping Dimensions**

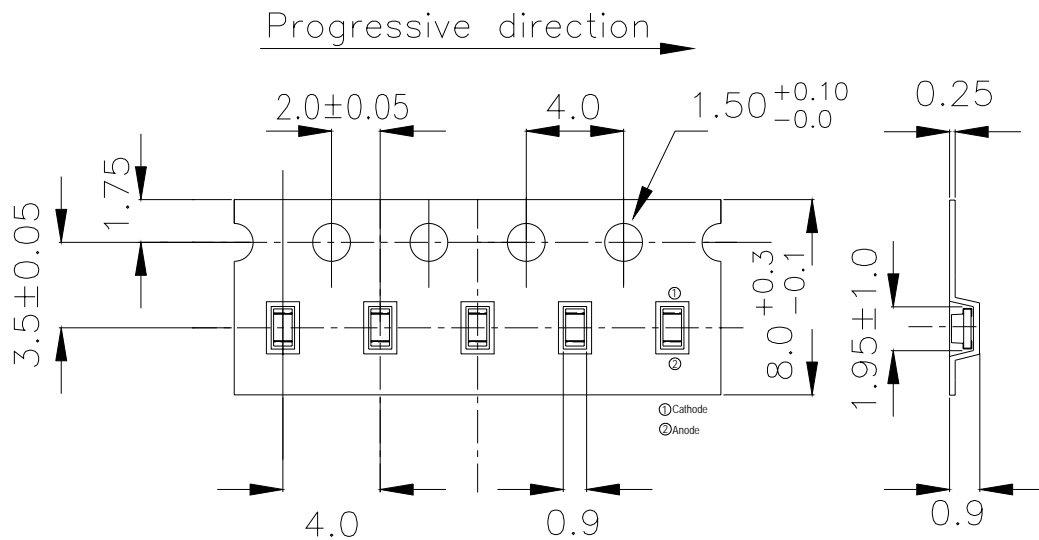

**Unit:mm**

### Packing Quantity Specification

- 1.3000Pcs/1Volume · 1Volume/1Bag
- 2.10Boxes/1Carton

### Label Form Specification

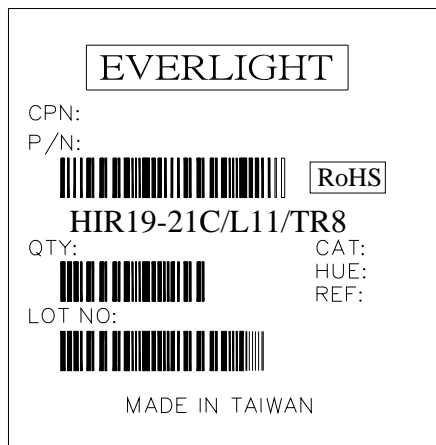

- CPN: Customer's Production Number
- P/N : Production Number
- QTY: Packing Quantity
- CAT: Ranks
- HUE: Peak Wavelength
- REF: Reference
- LOT No: Lot Number
- MADE IN TAIWAN: Production Place

### Notes

1. Above specification may be changed without notice. EVERLIGHT will reserve authority on material change for above specification.
2. When using this product, please observe the absolute maximum ratings and the instructions for using outlined in these specification sheets. EVERLIGHT assumes no responsibility for any damage resulting from use of the product which does not comply with the absolute maximum ratings and the instructions included in these specification sheets.
3. These specification sheets include materials protected under copyright of EVERLIGHT corporation. Please don't reproduce or cause anyone to reproduce them without EVERLIGHT's consent.

**EVERLIGHT ELECTRONICS CO., LTD.**  
Office: No 25, Lane 76, Sec 3, Chung Yang Rd,  
Tucheng, Taipei 236, Taiwan, R.O.C

Tel: 886-2-2267-2000, 2267-9936  
Fax: 886-2267-6244, 2267-6189, 2267-6306  
<http://www.everlight.com>

## Данный компонент на территории Российской Федерации

### Вы можете приобрести в компании MosChip.

Для оперативного оформления запроса Вам необходимо перейти по данной ссылке:

<http://moschip.ru/get-element>

Вы можете разместить у нас заказ для любого Вашего проекта, будь то серийное производство или разработка единичного прибора.

В нашем ассортименте представлены ведущие мировые производители активных и пассивных электронных компонентов.

Нашей специализацией является поставка электронной компонентной базы двойного назначения, продукции таких производителей как XILINX, Intel (ex.ALTERA), Vicor, Microchip, Texas Instruments, Analog Devices, Mini-Circuits, Amphenol, Glenair.

Сотрудничество с глобальными дистрибьюторами электронных компонентов, предоставляет возможность заказывать и получать с международных складов практически любой перечень компонентов в оптимальные для Вас сроки.

На всех этапах разработки и производства наши партнеры могут получить квалифицированную поддержку опытных инженеров.

Система менеджмента качества компании отвечает требованиям в соответствии с ГОСТ Р ИСО 9001, ГОСТ РВ 0015-002 и ЭС РД 009

### Офис по работе с юридическими лицами:

105318, г.Москва, ул.Щербаковская д.3, офис 1107, 1118, ДЦ «Щербаковский»

Телефон: +7 495 668-12-70 (многоканальный)

Факс: +7 495 668-12-70 (доб.304)

E-mail: [info@moschip.ru](mailto:info@moschip.ru)

Skype отдела продаж:

moschip.ru

moschip.ru\_4

moschip.ru\_6

moschip.ru\_9