

Product Overview

The QPB2328 is an HBT RF balanced amplifier IC operating as a return path amplifier capable of supporting DOCSIS 3.1 applications. This IC is designed to provide a low noise, high gain option for 5-210MHz interface using an 8V power supply to provide lower overall power dissipation. The QPB2328 can also be used in 5V and single ended applications with reduced linearity requirements. The QPB2328 is packaged in a convenient SOIC8 package and features an externally adjustable bias control.



Package: SOIC-8 with Exposed Pad

Functional Block Diagram

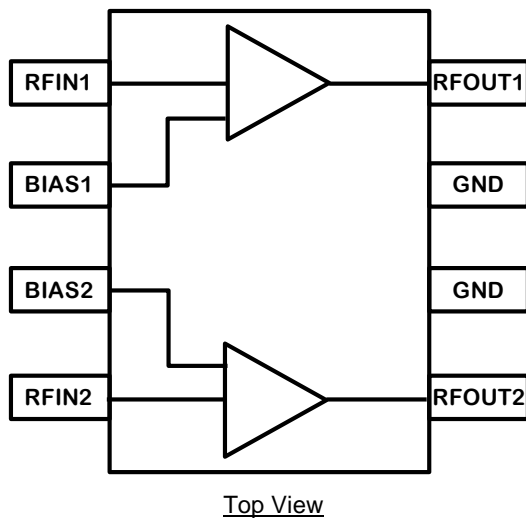

Key Features

- 5MHz to 210MHz Operation
- 8V and 5V Operation
- Gain; 17.5dB Typical
- Noise Figure 3.5dB Typical
- Adjustable Bias Using External Resistors
- SOIC-8 Exposed Pad

Applications

- Head End CMTS Equipment
- Post Amp for Return Path Optical Receivers
- DOCSIS 3.1 Optical Nodes
- Residential Amplifiers and Splitters

Ordering Information

Part No.	Description
QPB2328SQ	Sample bag with 25 pieces
QPB2328SR	7" Reel with 100 pieces
QPB2328TR13	13" Reel with 2500 pieces
QPB2328PCK	5 – 210 MHz PCBA with 5 pc sample bag

Absolute Maximum Ratings

Parameter	Rating
Supply Voltage (V_{DD})	+10V
Supply Current (I_{DD})	350mA
Maximum CW Input Power for $V_{DD}=8V$	+16dBm
Operating Temperature Range	-40 to +85 °C
Storage Temperature Range	-65 to +150 °C
Maximum Junction Temperature	+150 °C

Exceeding any one or a combination of the Absolute Maximum Rating conditions may cause permanent damage to the device. Extended application of Absolute Maximum Rating conditions to the device may reduce device reliability.

Electrical Specifications – Push-Pull Configuration, 8V

Parameter	Condition ⁽¹⁾	Min	Typ	Max	Unit
Supply Voltage (V_{DD})			8		V
Supply Current (I_{DD})			235		mA
Frequency Range		5		210	MHz
Gain	Full Band		17.8		dB
Gain Flatness			±0.2		dB
Gain Tilt	Gain(210MHz) - Gain(5MHz)		0.15		dB
Input Return Loss	Full Band		19		dB
Output Return Loss	Full Band		25		dB
Reverse Isolation	Full Band		22		dB
Noise Figure	Includes balun loss		3.5		dB
DTO	f1=13MHz, f2=19MHz 61dBmV per tone		70		-dBc
DSO	f1=13MHz, f2=19MHz 61dBmV per tone		82		-dBc
ACLR	Pout = 64dBmV, 5-195MHz OFDM w/ 9.6MHz exclusion band.		63		dB
OIP2	12dBm/tone, F1 = 113MHz, F2 = 119MHz		93		dBm
OIP3	12dBm/tone, F1 = 113MHz, F2 = 119MHz		46		dBm
Output P1dB	Full Band		27		dBm
Thermal Resistance	Θ_{JC}		12		°C/W

Notes:

1. Typical performance at these conditions: Temp = +25°C, V_{DD} = +8V, 75Ω system

Electrical Specifications – Single Ended, 8V (50Ω)

Parameter	Condition ⁽¹⁾	Min	Typ	Max	Unit
Supply Current (I_{DD})			114		mA
Gain			17.75		dB
OIP2L	9dBm/tone, F1 = 113MHz, F2 = 123MHz		57.7		dBm
OIP2H	9dBm/tone, F1 = 113MHz, F2 = 123MHz		58.8		dBm
OIP3	9dBm/tone, F1 = 113MHz, F2 = 123MHz		43.9		dBm

Notes:

1. Typical performance at these conditions: Singled ended configuration, Temp = +25°C, V_{DD} = +8V, **50Ω system**
2. 50ohm data represents factory test conditions

Electrical Specifications – Push-Pull Configuration, 5V

Parameter	Condition ⁽¹⁾	Min	Typ	Max	Unit
Supply Voltage (V_{DD})			5		V
Supply Current (I_{DD})			100		mA
Frequency Range		5		210	MHz
Gain	Full Band		17.5		dB
Gain Flatness			±0.2		dB
Gain Tilt	Gain(210MHz) - Gain(5MHz)		0.15		dB
Input Return Loss	Full Band		19		dB
Output Return Loss	Full Band		24		dB
Reverse Isolation	Full bandwidth		22		dB
Noise Figure	Includes balun loss		3.5		dB
DTO	f1=13MHz, f2=19MHz 53dBmV per tone		64		-dBc
DSO	f1=13MHz, f2=19MHz 53dBmV per tone		76		-dBc
ACLR	Pout = 56dBmV, 5-195MHz OFDM w/ 9.6MHz exclusion band.		62		dB
OIP2	4dBm/tone, F1 = 113MHz, F2 = 119MHz		82		dBm
OIP3	4dBm/tone, F1 = 113MHz, F2 = 119MHz		36.5		dBm
Output P1dB	Full Band		22		dBm

Notes:

1. Typical performance at these conditions: Temp = +25°C, V_{DD} = +5V, 75Ω system



Electrical Specifications – Single Ended Configuration, 5V

Parameter	Condition ⁽¹⁾	Min	Typ	Max	Unit
Supply Voltage (V_{DD})			5		V
Supply Current (I_{DD})			55		mA
Frequency Range		5		210	MHz
Gain	Full Band		18.7		dB
Gain Flatness			± 0.2		dB
Gain Tilt	Gain(210MHz) - Gain(5MHz)		0.2		dB
Input Return Loss	Full Band		22		dB
Output Return Loss	Full Band		21		dB
Reverse Isolation	Full bandwidth		21		dB
Noise Figure	Full bandwidth		3		dB
DTO	f1=13MHz, f2=19MHz 46dBmV per tone		74		-dBc
DSO	f1=13MHz, f2=19MHz 46dBmV per tone		49		-dBc
ACLR	Pout = 48dBmV, 5-195MHz OFDM w/ 9.6MHz exclusion band.		61		dB
OIP2	-3dBm/tone, F1 = 113MHz, F2 = 119MHz		47		dBm
OIP3	-3dBm/tone, F1 = 113MHz, F2 = 119MHz		36		dBm
Output P1dB	Full Band		19.5		dBm

Notes:

1. Typical performance at these conditions: Temp = +25°C, V_{DD} = +5V applied to single ended amplifier path, 75Ω system

Evaluation Board Schematic 5-210MHz

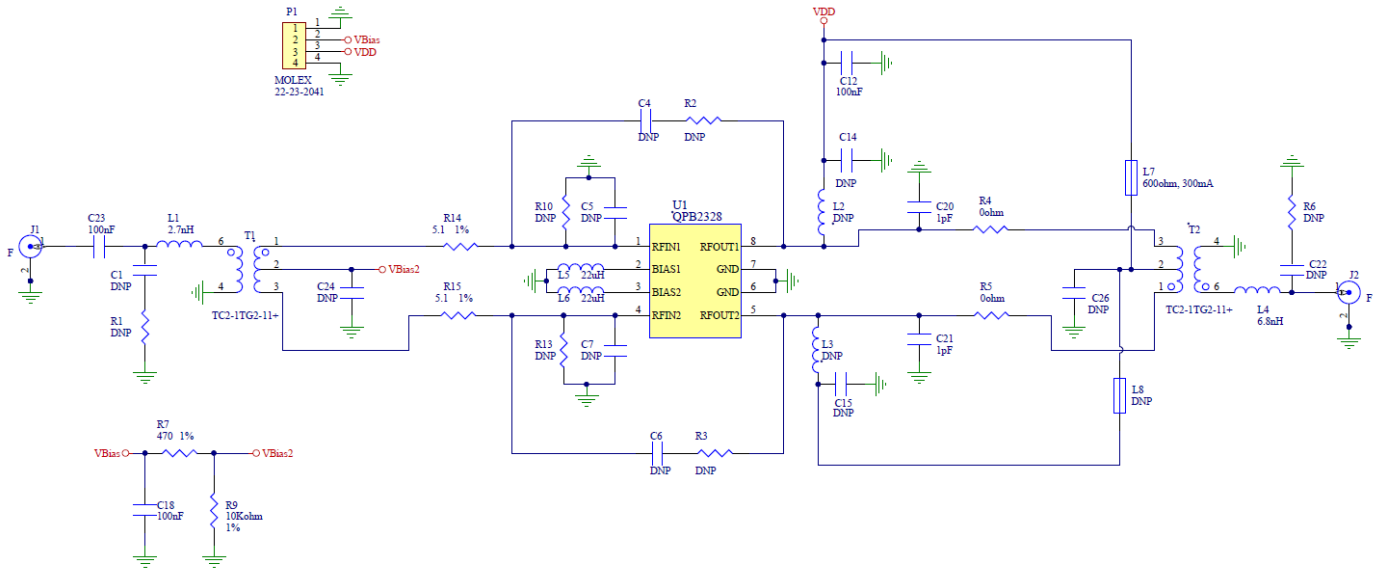



QPB2328

17.5 dB Balanced Return Path Amplifier 5 – 210 MHz

Evaluation Board Bill of Materials

Designator	Description	Manufacturer	Part Number
PCB	QPB2318-4000	DDI	QPB2318-4000(A)
C12, C18, C23	CAP, 0.1uF, 10%, 16V, X7R, 0402	Murata Electronics	GRM155R71C104KA88D
C20, C21	1.0PF, .1PF, 50, NPO, 0402, LF LEAD FREE	Murata Electronics	GRM1555C1H1R0BZ01D
J1, J2	CONN, F FEM EDGE MOUNT, 75 OHMS, 0.068"	Millimeter Wave Technologies, LLC	MW-846-C-DD-75
L1	IND, 2.7nH, +/-0.3nH, M/L, 0402	Murata Electronics	LQG15HS2N7S02D
L4	IND, 6.8nH, 5%, M/L, 0402	Murata Electronics	LQG15HN6N8J02D
L5, L6	IND, 22uH, 20%, 190mA, M/L, 0603	TDK	MLZ1608N220LT000
L7	FER, BEAD, 600 OHM, 300mA, 0402	Murata	BLM15HG601SN
P1	CONN, HDR, ST, FRCTN LOCK, 4-PIN	MOLEX	22-23-2041
R14, R15	RES, 5.1 OHM, 1%, 1/10W, 0402	Kamaya, Inc	RMC1/16SK5R10FTH
R4, R5	JMPR, 0 OHM, 0402	Panasonic Industrial Devices Sales	ERJ-2GE0R00
R7	Res, 470R /1%/0402/TK100/Chip	Kamaya, Inc	RMC1/16SK4700FTH
R9	RES, 10K, 1%, 1/16W, 0402	Panasonic Industrial Devices Sales	ERJ-2RKF1002X
T1, T2	XFMR, 3-300MHz, 50 OHM, 250mW, AT224-3	Minicircuits	TC2-1TG2-11+
U1	17.5dB High-Linearity Push-Pull MMIC	Qorvo	QPB2328
C1, C4, C5, C6, C7, C14, C15, C22, C24, C26, L2, L3, L8, R1, R2, R3, R6, R10, R13	DNP	N/A	N/A
HS1	Heat Sink 1.5 x 2	Shenzhen Minxingda Automation Equip	211086
S1, S2, S3, S4	Screw, 2-56x3/16:, Socket Head	McMaster-Carr Supply Co.	92196A076

Evaluation Board Assembly Drawing

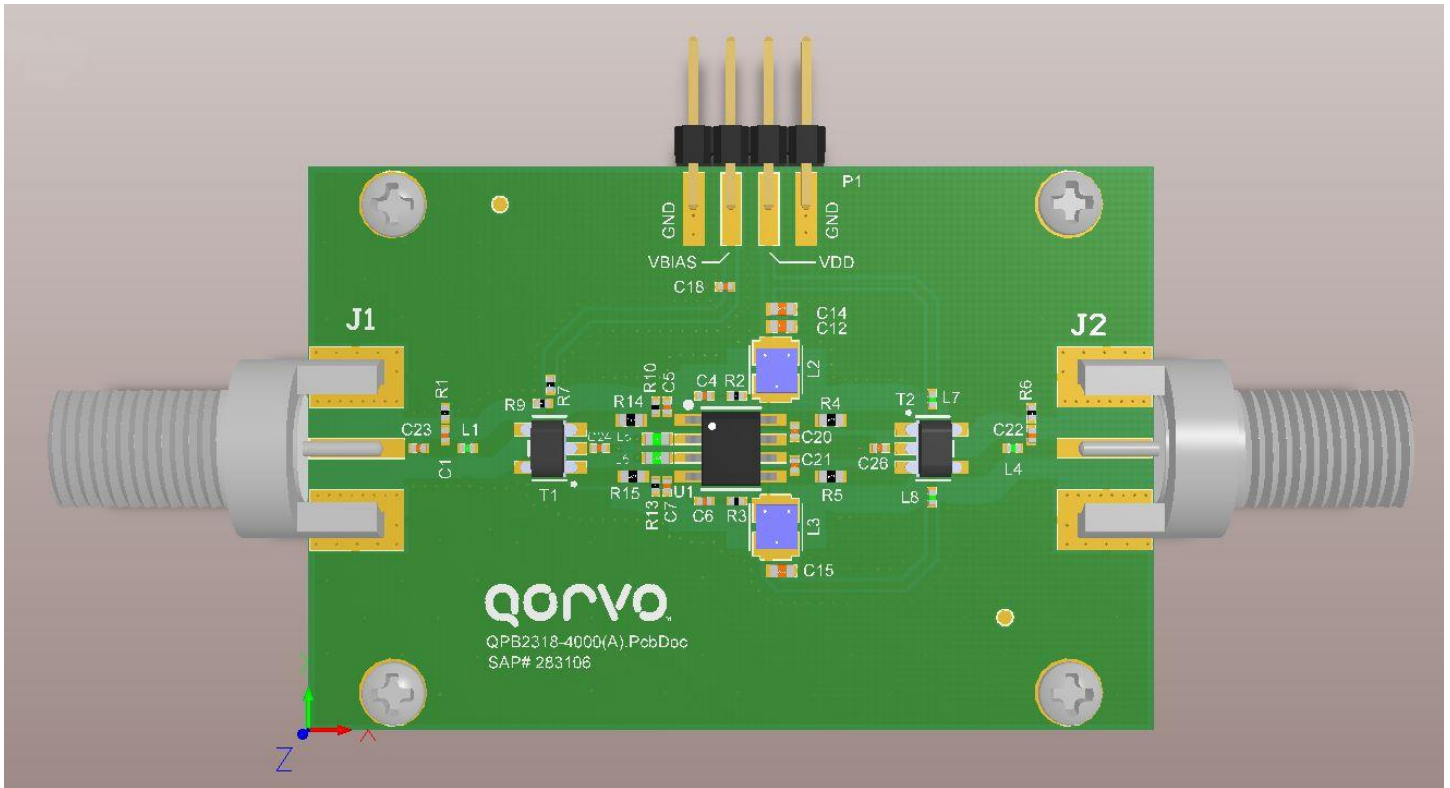

Typical Application Schematic – Push-Pull Configuration

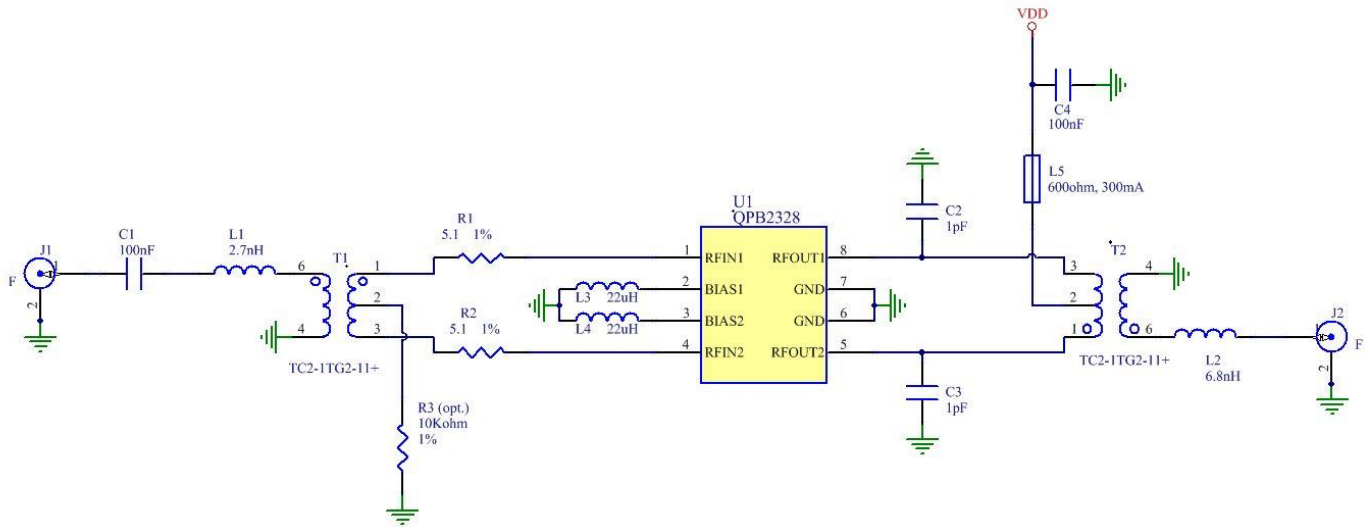

Typical Application Schematic – Single Ended Configuration

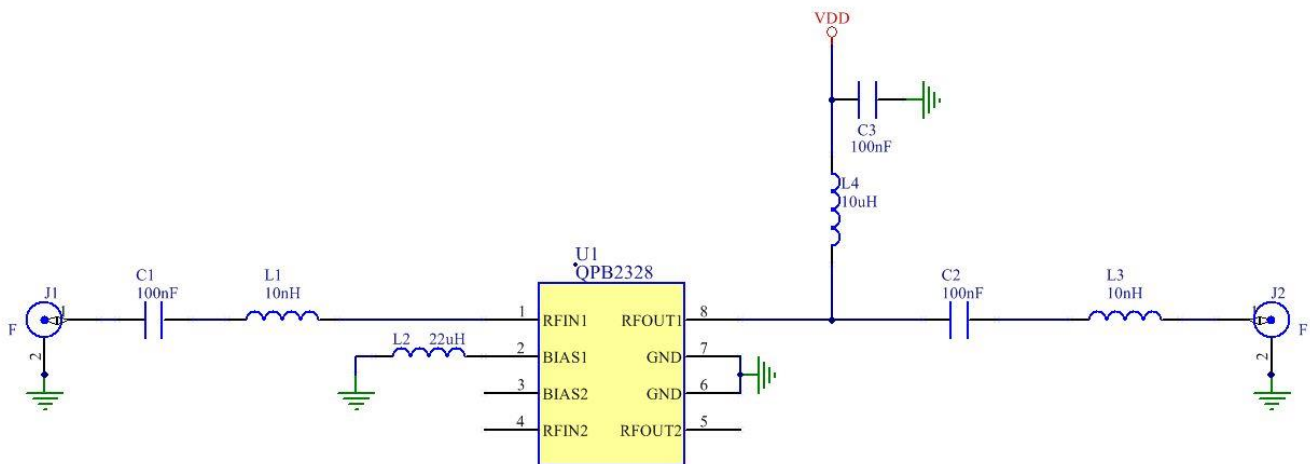

Performance Data – Push-Pull Configuration, 8V

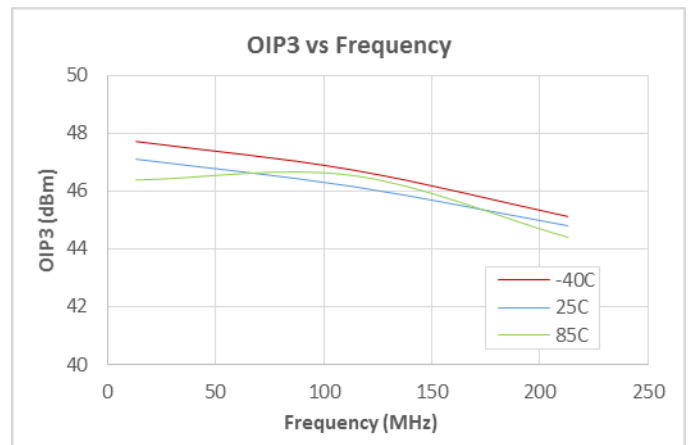
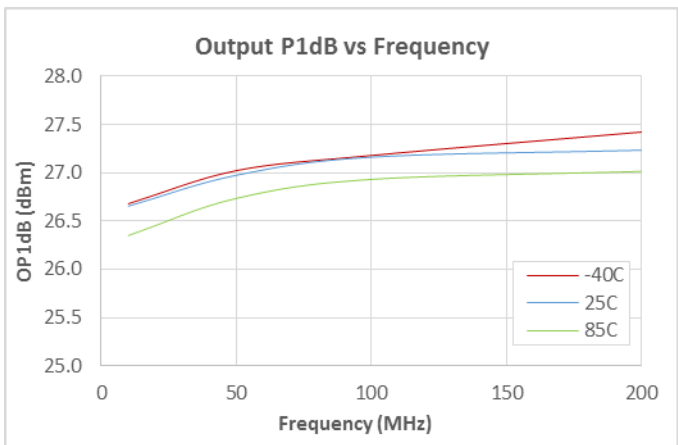
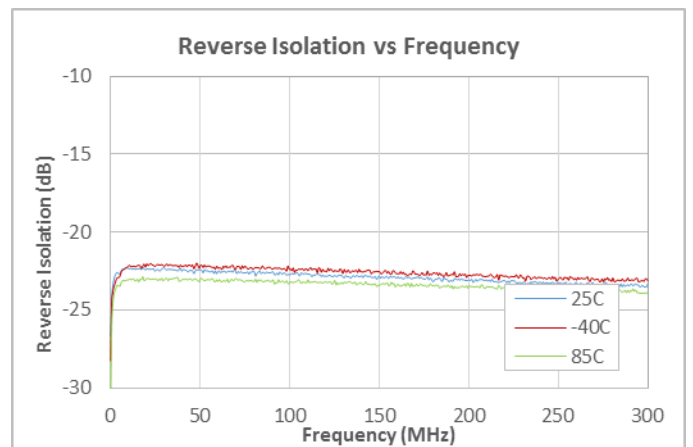
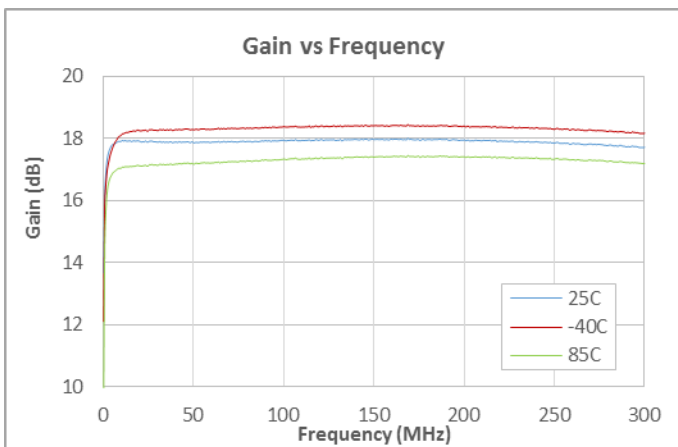
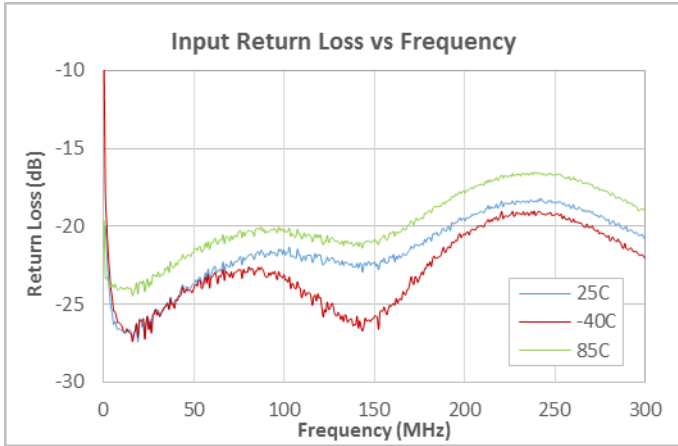

Notes:
(1) OIP3: 12dBm/tone, F1 = 113MHz, F2 = 119MHz

Performance Data – Push-Pull Configuration, 8V

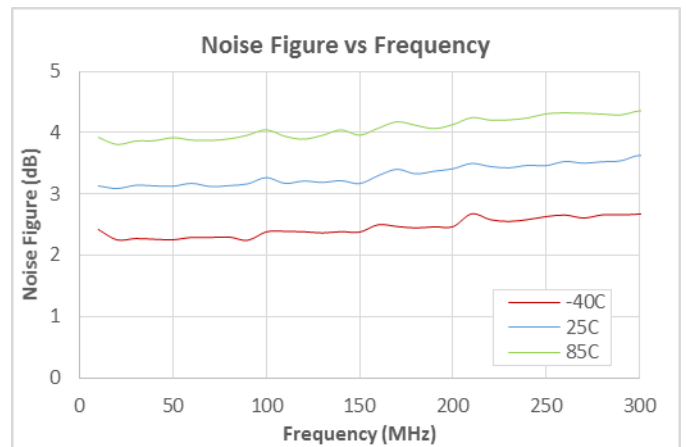
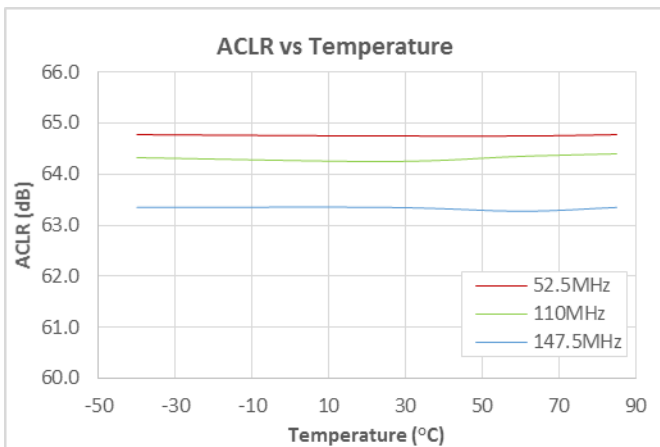
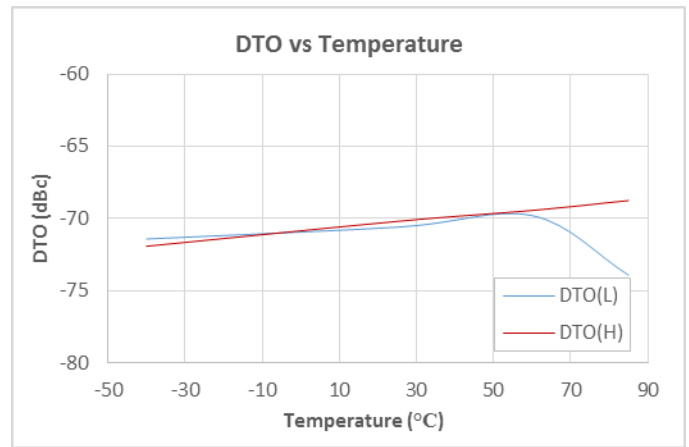
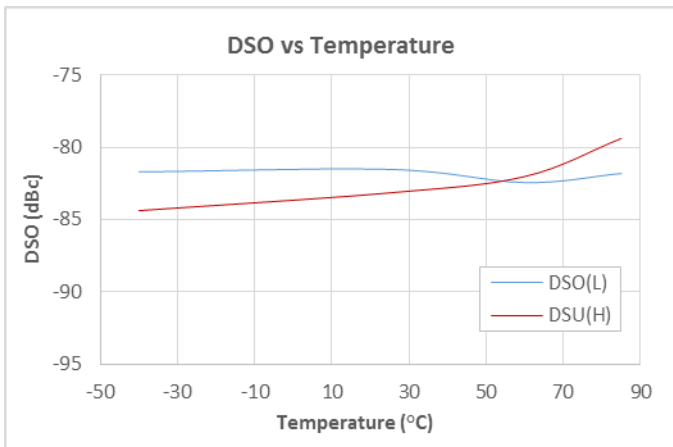
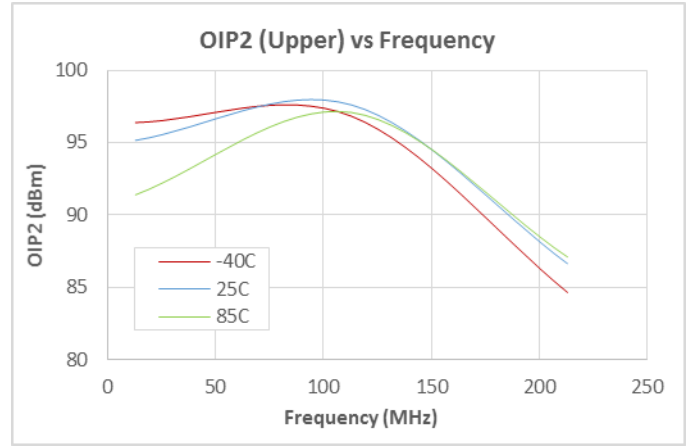
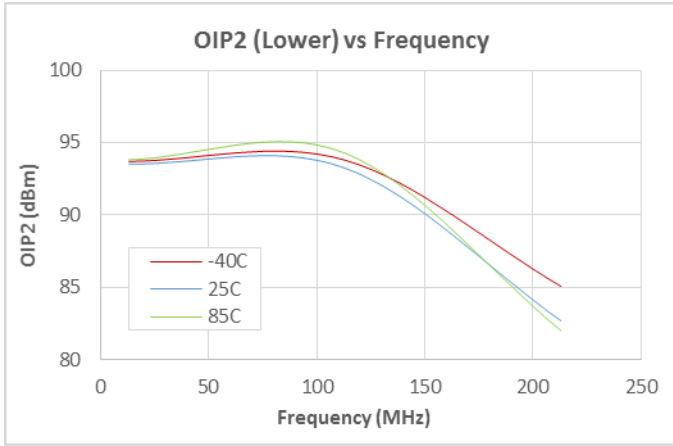

Notes:

- (2) OIP2: 12dBm/tone, F1 = 113MHz, F2 = 119MHz
- (3) DSO/DTO: f1=13MHz, f2=19MHz 61dBmV per tone
- (4) ACLR: Pout = 64dBmV, 5-195MHz OFDM w/ 9.6MHz exclusion band.

Performance Data – Push-Pull Configuration, 8V

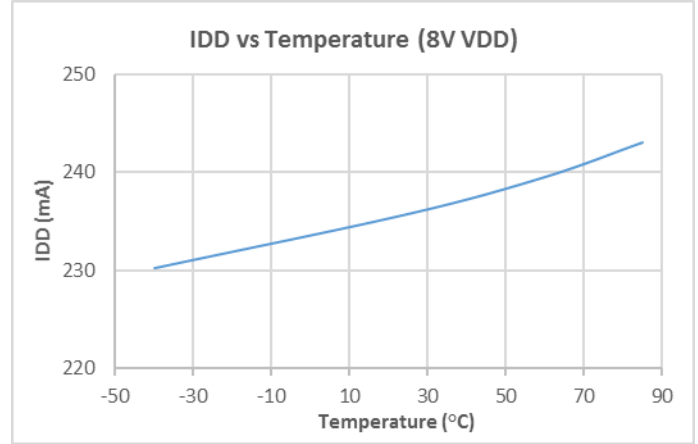
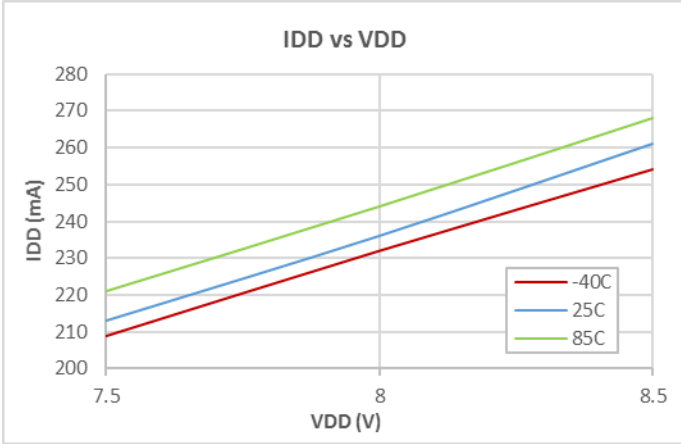

Performance Data – Push-Pull Configuration, 5V

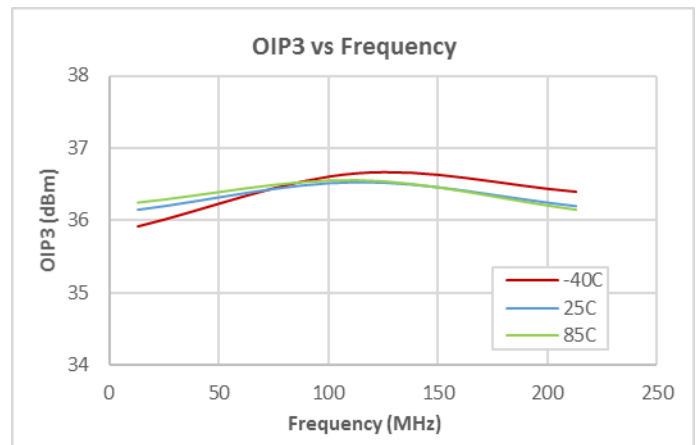
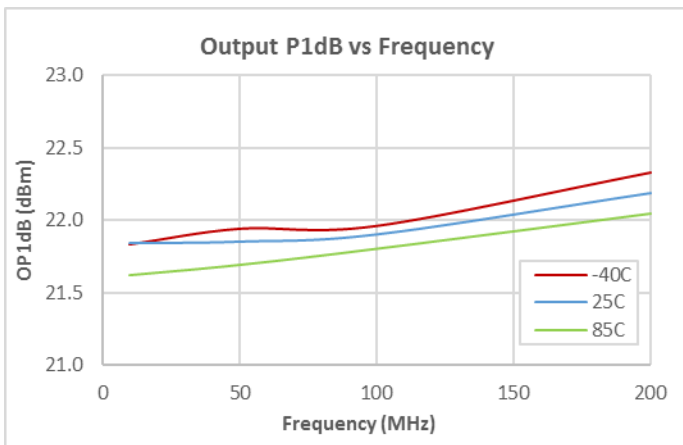
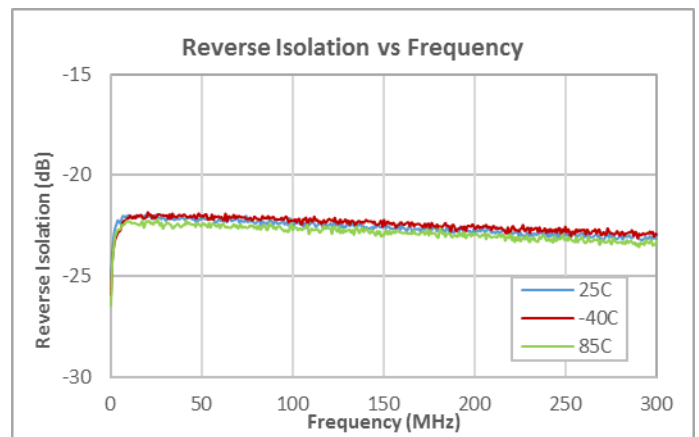
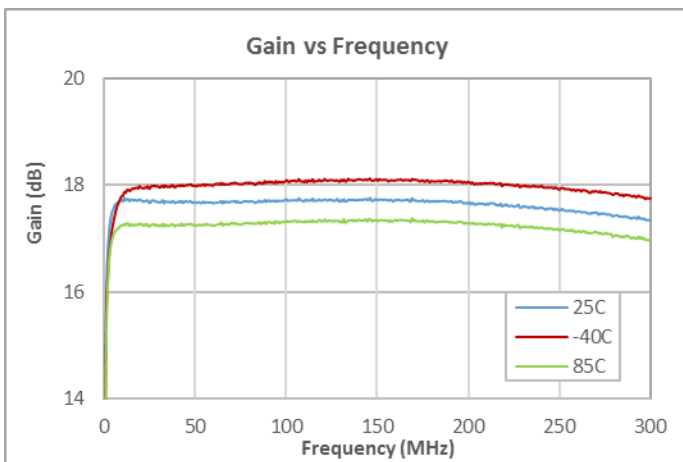
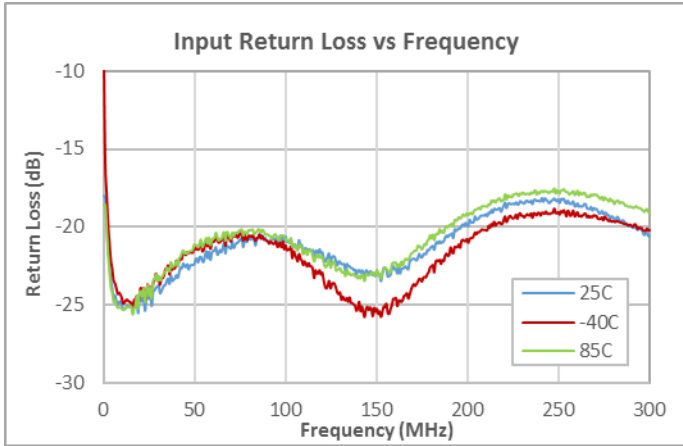

Notes:

- (1) OIP3: 4dBm/tone, F1 = 113MHz, F2 = 119MHz

Performance Data – Push-Pull Configuration, 5V

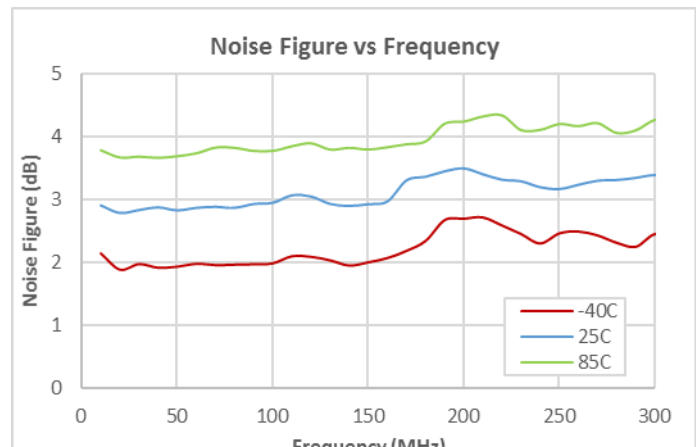
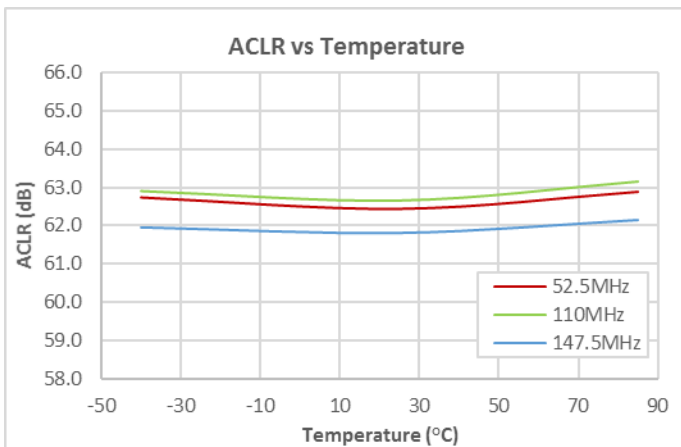
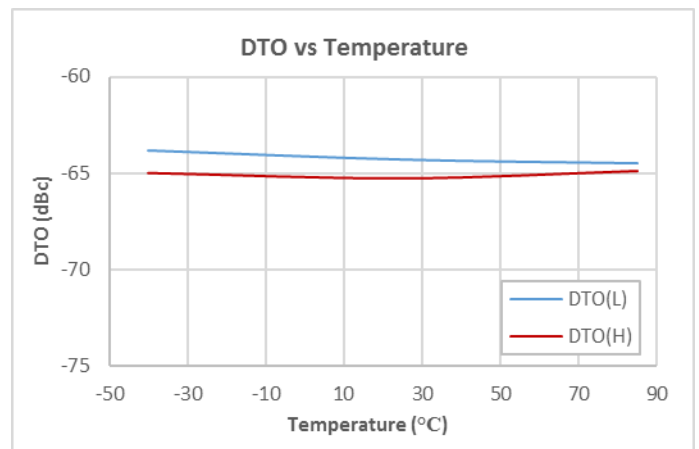
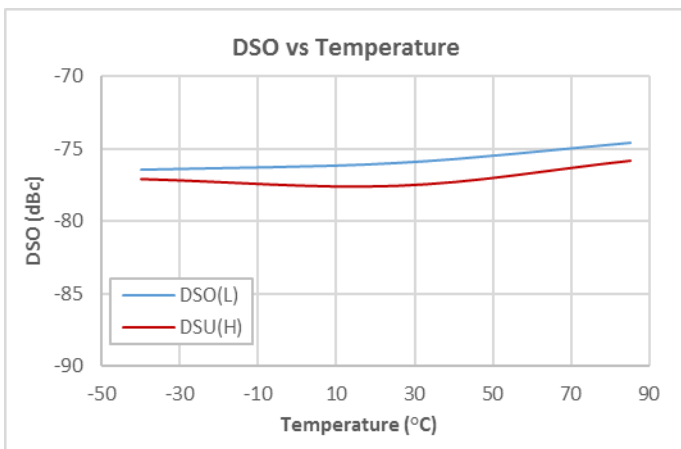
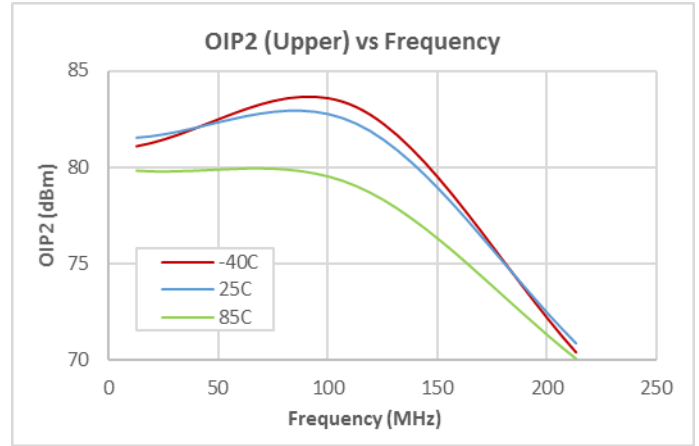
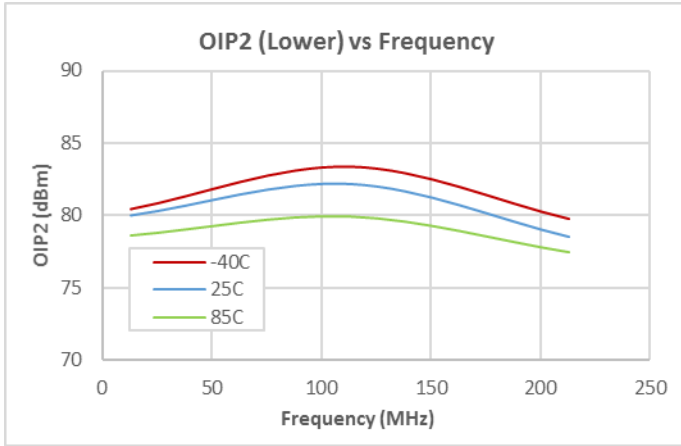

Notes:

- (1) OIP2: 4dBm/tone, F1 = 113MHz, F2 = 119MHz
- (2) DSO/DTO: f1=13MHz, f2=19MHz 53dBmV per tone
- (3) ACLR: Pout = 56dBmV, 5-195MHz OFDM w/ 9.6MHz exclusion band.

Performance Data – Push-Pull Configuration, 5V

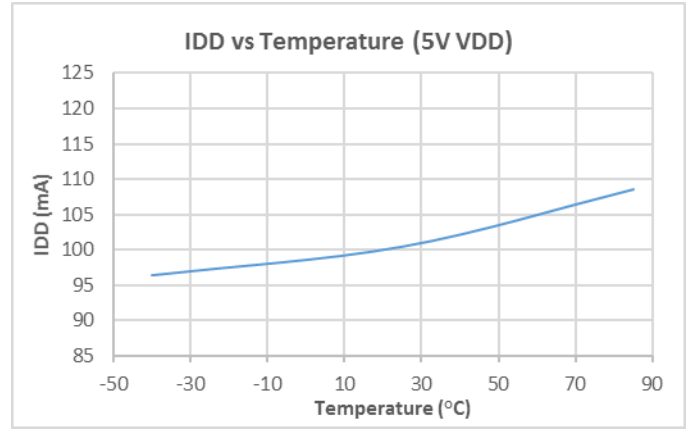
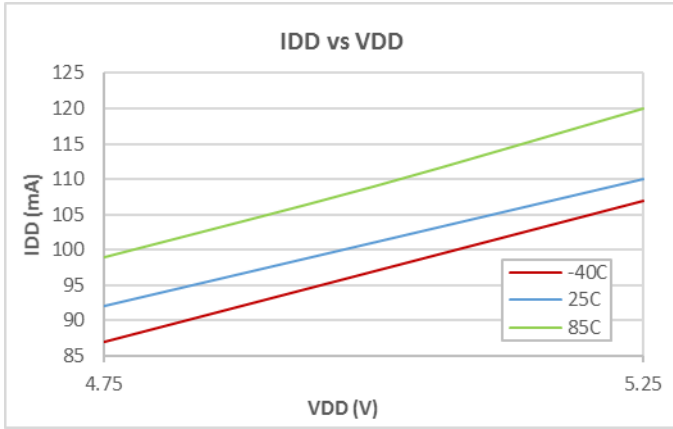

Performance Data – Single Ended Configuration, 5V

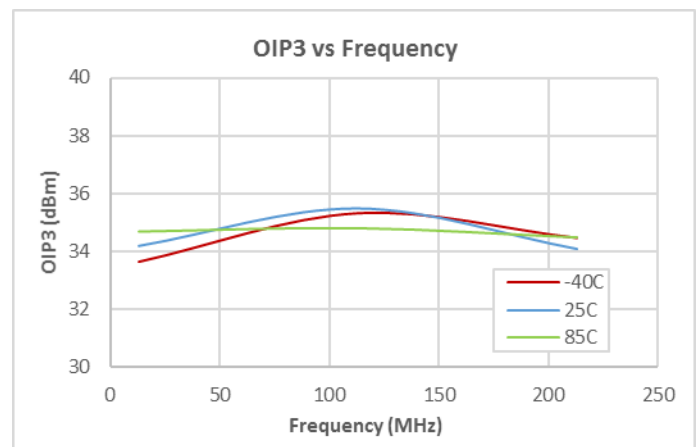
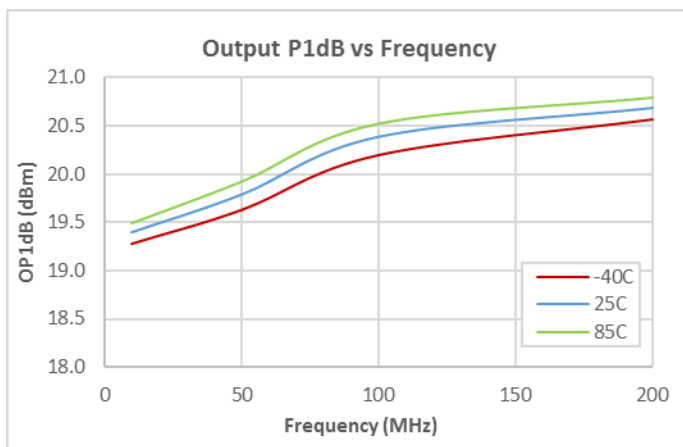
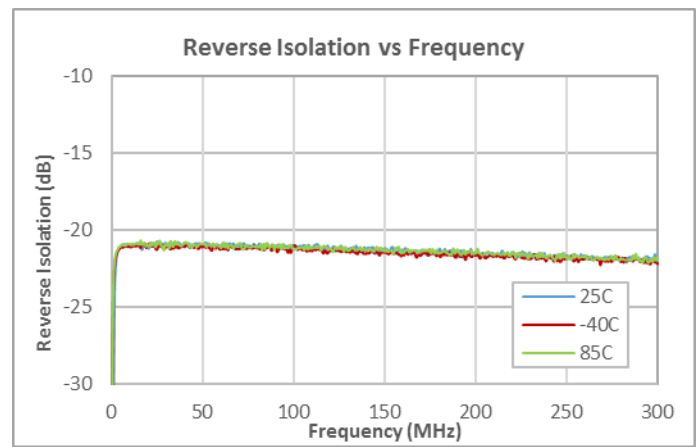
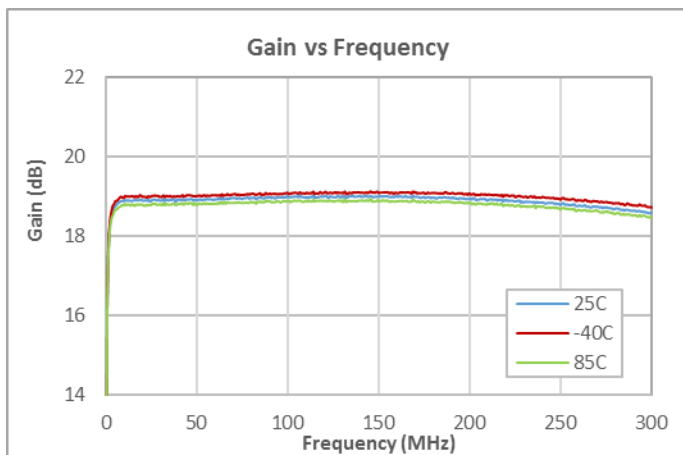
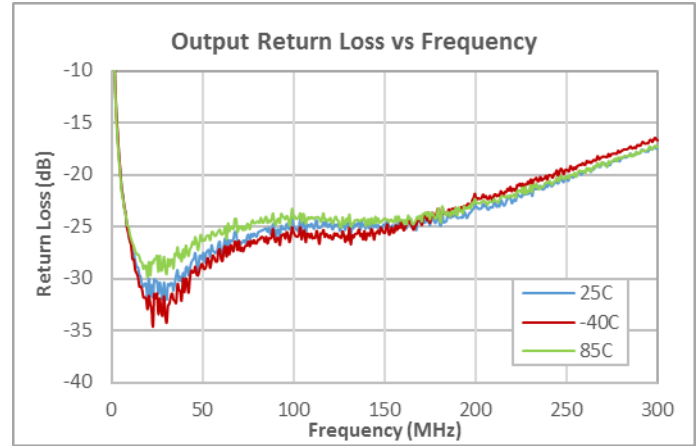

Notes:
(1) OIP3: -3dBm/tone, F1 = 113MHz, F2 = 119MHz

Performance Data – Single Ended Configuration, 5V

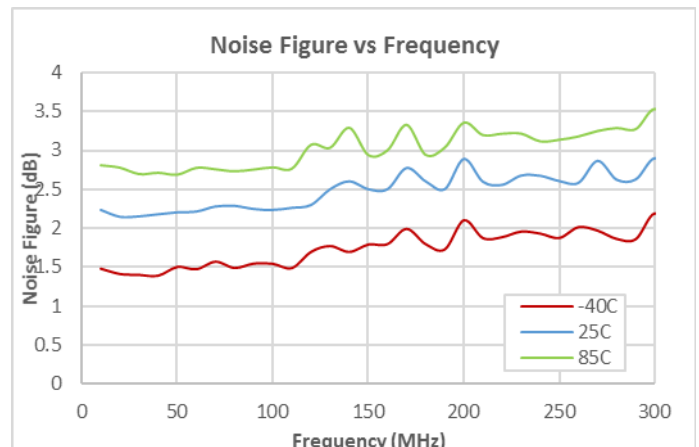
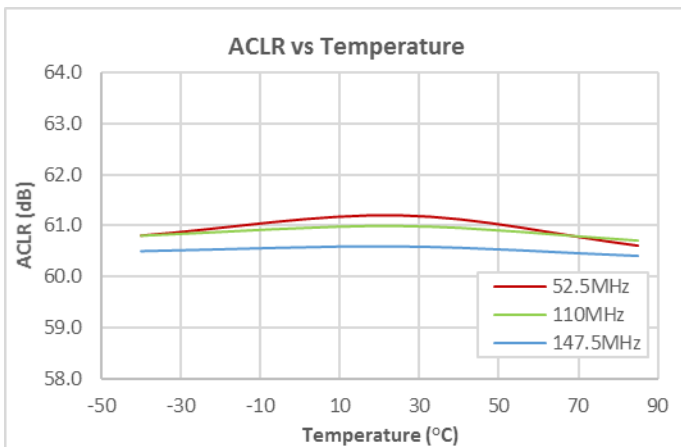
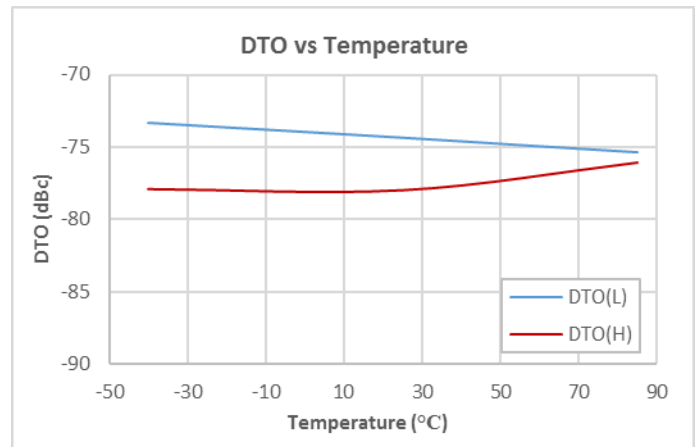
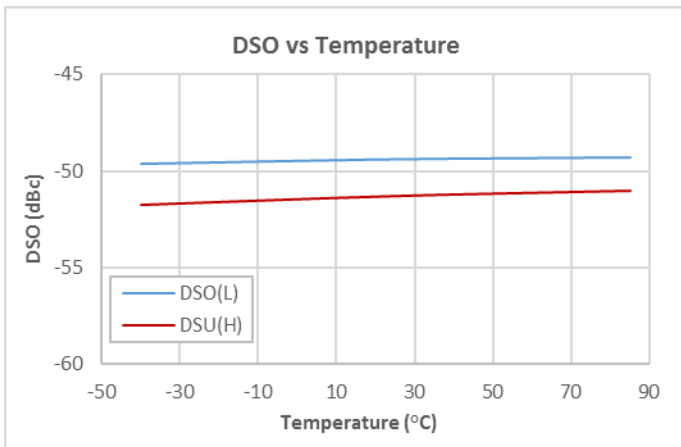
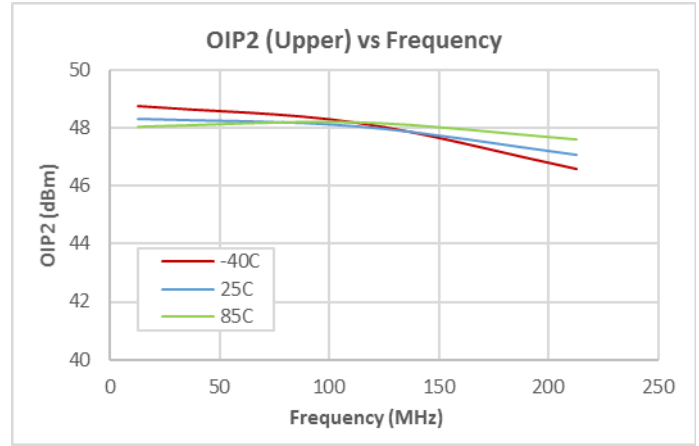
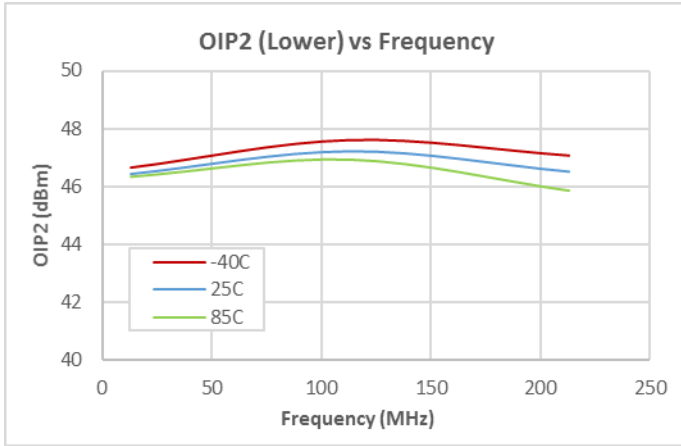

Notes:

- (1) OIP2: -3dBm/tone, F1 = 113MHz, F2 = 119MHz
- (2) DSO/DTO: f1=13MHz, f2=19MHz 46dBmV per tone
- (3) ACLR: Pout = 49dBmV, 5-195MHz OFDM w/ 9.6MHz exclusion band.

Performance Data – Single Ended Configuration, 5V

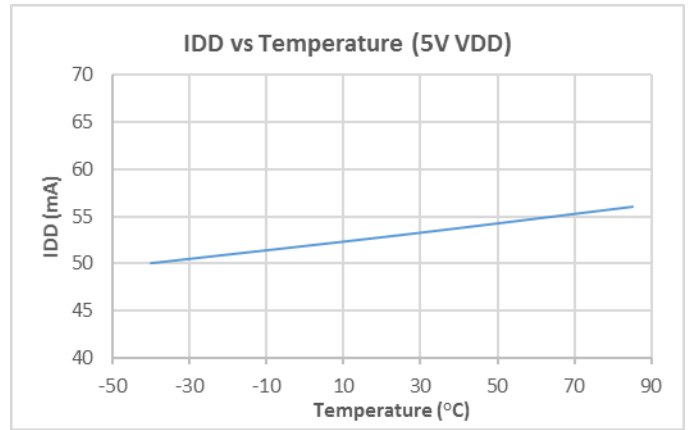
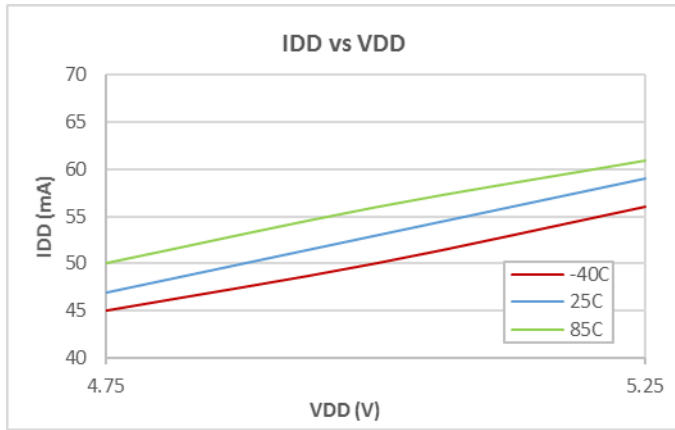

Pad Configuration and Description

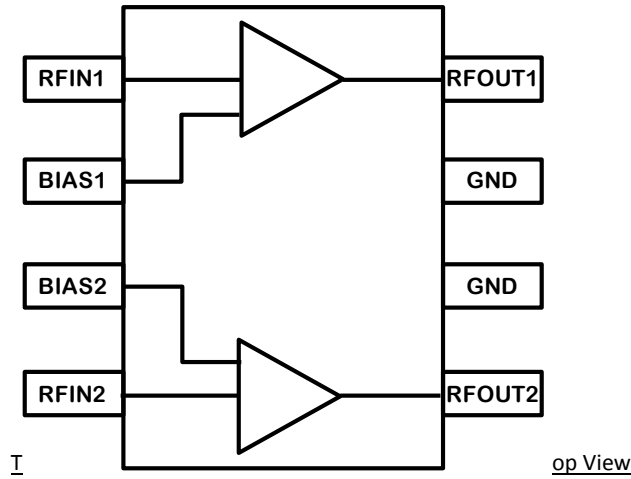

Pad No.	Label	Description
1	RFIN1	RF input for AMP1
2	BIAS1	AMP1 bias, requires choke to ground
3	BIAS2	AMP2 bias, requires choke to ground
4	RFIN2	RF input for AMP2
5	RFOUT2	RF output for AMP2
6	GND	Internally Not Connected
7	GND	Internally Not Connected
8	RFOUT1	RF output for AMP1
Backside Paddle	GND	Ground. Use recommended via pattern to minimize inductance and thermal resistance. See PCB Mounting Pattern for suggested footprint.

Package Outline

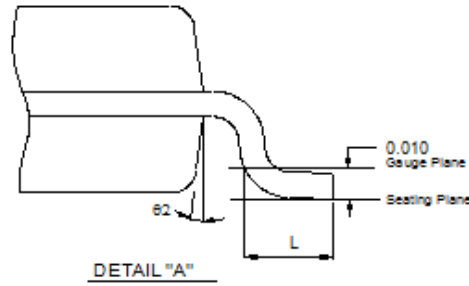
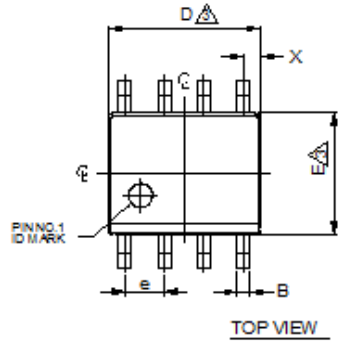

SYMBOL	8 SOIC	
	MIN	MAX
A	0.054	0.068
A1	0.001	0.004
B	0.014	0.019
D	0.189	0.196
E	0.150	0.157
H	0.229	0.244
M	0.087	0.097
N	0.082	0.092
e	0.050 BSC	
C	0.0075	0.0098
L	0.020	0.040
X	0.0215 REF	
61	0°	8°
62	7° BSC	

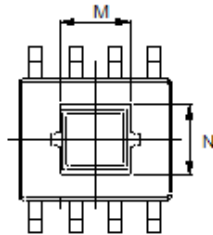
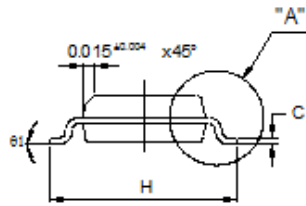
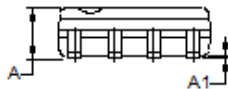

EXPOSED PADDLE

NOTE:

1. TOP PACKAGE SURFACE TO BE Ni, Pd, Au PLATING
2. BOTTOM PACKAGE SURFACE TO BE Ni, Pd, Au PLATING
3. DIMENSIONS ARE EXCLUSIVE MOLD FLASH AND GATE BURR.
4. FOOT LENGTH MEASURING IS BASED ON THE GAUGE PLANE METHOD.

Notes:

1. Dimensions in millimeters

Package Marking

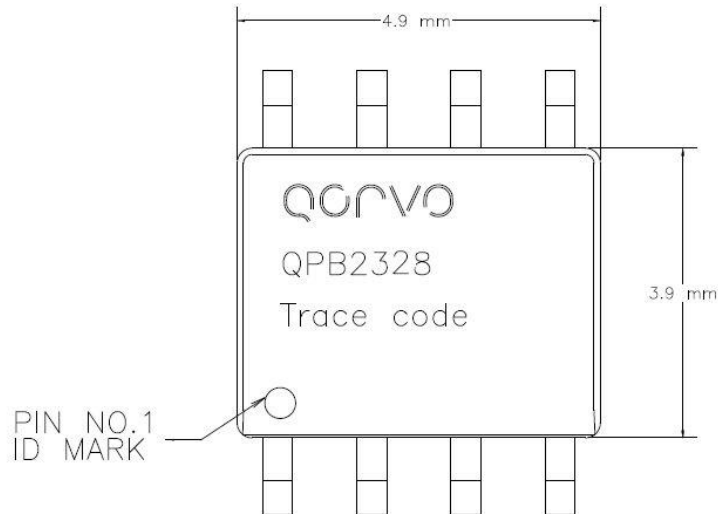

Recommended Mounting Pattern

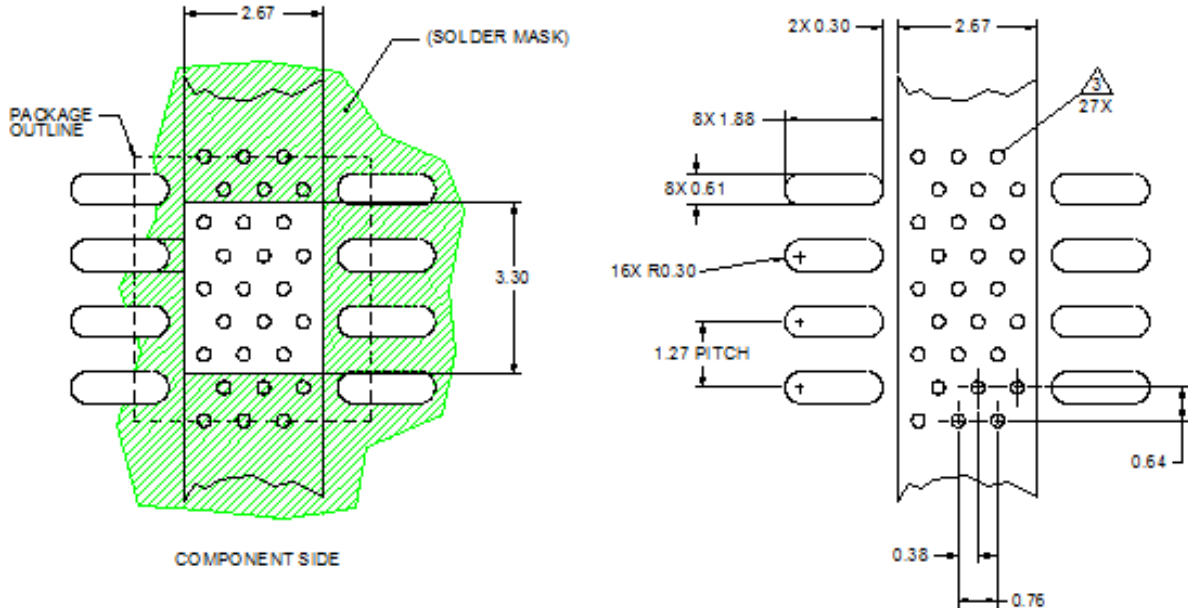

Notes:

1. All dimensions are in millimeters. Angles are in degrees.
2. Use 1oz. copper minimum for top and bottom layers
3. Vias are required under the backside paddle for proper RF/DC grounding and thermal dissipation. We recommend a 0.35mm (#80/0.135") diameter bit for drilling via holes and a final plated through diameter of 0.25mm (0.010").
4. Ensure good backside paddle solder attach for reliable operation and best electrical performance.

Handling Precautions

Parameter	Rating	Standard
ESD – Human Body Model (HBM)	1B	ESDA / JEDEC JS-001-2012
ESD – Charged Device Model (CDM)	C3	JEDEC JESD22-C101F
MSL – Moisture Sensitivity Level	MSL3	IPC/JEDEC J-STD-020



Caution!
 ESD-Sensitive Device

Solderability

Compatible with both lead-free (260°C max. reflow temp.) and tin/lead (245°C max. reflow temp.) soldering processes. Solder profiles available upon request.

Contact plating: NiPdAu

RoHS Compliance

This part is compliant with 2011/65/EU RoHS directive (Restrictions on the Use of Certain Hazardous Substances in Electrical and Electronic Equipment) as amended by Directive.

This product also has the following attributes:

- Lead Free
- Halogen Free (Chlorine, Bromine)
- Antimony Free
- TBBP-A (C₁₅H₁₂Br₄O₂) Free
- PFOS Free
- SVHC Free



Contact Information

For the latest specifications, additional product information, worldwide sales and distribution locations:

Tel: 1-844-890-8163

Web: www.qorvo.com

Email: customer.support@qorvo.com

Important Notice

The information contained herein is believed to be reliable; however, Qorvo makes no warranties regarding the information contained herein and assumes no responsibility or liability whatsoever for the use of the information contained herein. All information contained herein is subject to change without notice. Customers should obtain and verify the latest relevant information before placing orders for Qorvo products. The information contained herein or any use of such information does not grant, explicitly or implicitly, to any party any patent rights, licenses, or any other intellectual property rights, whether with regard to such information itself or anything described by such information. **THIS INFORMATION DOES NOT CONSTITUTE A WARRANTY WITH RESPECT TO THE PRODUCTS DESCRIBED HEREIN, AND QORVO HEREBY DISCLAIMS ANY AND ALL WARRANTIES WITH RESPECT TO SUCH PRODUCTS WHETHER EXPRESS OR IMPLIED BY LAW, COURSE OF DEALING, COURSE OF PERFORMANCE, USAGE OF TRADE OR OTHERWISE, INCLUDING THE IMPLIED WARRANTIES OF MERCHANTABILITY AND FITNESS FOR A PARTICULAR PURPOSE.**

Without limiting the generality of the foregoing, Qorvo products are not warranted or authorized for use as critical components in medical, life-saving, or life-sustaining applications, or other applications where a failure would reasonably be expected to cause severe personal injury or death.

Copyright 2017 © Qorvo, Inc. | Qorvo is a registered trademark of Qorvo, Inc.

Данный компонент на территории Российской Федерации

Вы можете приобрести в компании MosChip.

Для оперативного оформления запроса Вам необходимо перейти по данной ссылке:

<http://moschip.ru/get-element>

Вы можете разместить у нас заказ для любого Вашего проекта, будь то серийное производство или разработка единичного прибора.

В нашем ассортименте представлены ведущие мировые производители активных и пассивных электронных компонентов.

Нашей специализацией является поставка электронной компонентной базы двойного назначения, продукции таких производителей как XILINX, Intel (ex.ALTERA), Vicor, Microchip, Texas Instruments, Analog Devices, Mini-Circuits, Amphenol, Glenair.

Сотрудничество с глобальными дистрибьюторами электронных компонентов, предоставляет возможность заказывать и получать с международных складов практически любой перечень компонентов в оптимальные для Вас сроки.

На всех этапах разработки и производства наши партнеры могут получить квалифицированную поддержку опытных инженеров.

Система менеджмента качества компании отвечает требованиям в соответствии с ГОСТ Р ИСО 9001, ГОСТ РВ 0015-002 и ЭС РД 009

Офис по работе с юридическими лицами:

105318, г.Москва, ул.Щербаковская д.3, офис 1107, 1118, ДЦ «Щербаковский»

Телефон: +7 495 668-12-70 (многоканальный)

Факс: +7 495 668-12-70 (доб.304)

E-mail: info@moschip.ru

Skype отдела продаж:

moschip.ru

moschip.ru_4

moschip.ru_6

moschip.ru_9