



Features

- Repeatable settings
- Resolution to 0.001 %
- Digital display provides excellent readability
- Snap-in panel mount

3680 Family - Precision Potentiometer

Electrical Characteristics¹

Standard Resistance Range	10 ohms to 1 megohm
Total Resistance Tolerance	±3 %
Dielectric Withstanding Voltage (MIL-STD-202, Method 301) Sea Level	1,000 VAC minimum
Power Rating (Voltage Limited By Power Dissipation or 500 VAC, Whichever is Less)	
+25 °C2 watts
+85 °C0 watt
Insulation Resistance (500 VDC)	1,000 megohms minimum
Resolution	
368110 %
36821 %
36830.1 %
36840.01 %
36850.001 %
Absolute Minimum Resistance3 ohms or 0.2 % maximum (whichever is greater)
Accuracy (Dial Reading to Output Ratio)	±1.0 % full scale

Environmental Characteristics¹

Operating Temperature Range	-25 °C to +85 °C
Storage Temperature Range	-25 °C to +85 °C
Temperature Coefficient Over Storage Temperature Range	±100 ppm/°C maximum
Vibration	10 G
Wiper Bounce0.1 millisecond maximum
Total Resistance Shift	±1 % maximum
Voltage Ratio Shift	±0.2 % maximum
Shock	50 G
Wiper Bounce0.1 millisecond maximum
Total Resistance Shift	±1 % maximum
Voltage Ratio Shift	±0.2 % maximum
Load Life	1,000 hours, 2 watts
Total Resistance Shift	±2 % maximum
Rotational Life	75,000 button operations each decade
Total Resistance Shift	±2 % maximum
IP Rating	IP 40

Mechanical Characteristics¹

Weight	3681 (9 gm); 3682 (16 gm); 3683 (23 gm); 3684 (30 gm); 3685 (37 gm)
Terminals	2.79 mm (0.11 in.) wide x .41 mm (.016 in.) thick, tinned solder lugs for 3 #20 AWG wires
Soldering Condition	
Manual Soldering96.5Sn/3.0Ag/0.5Cu solid wire or no-clean rosin cored wire; 370 °C (700 °F) max. for 3 seconds
Wave Soldering96.5Sn/3.0Ag/0.5Cu solder with no-clean flux; 260 °C (500 °F) max. for 5 seconds
Wash processes	Not recommended
Marking	Manufacturer's name and part number, resistance value and date code.
Ganging (Multiple Section Potentiometers)	Up to 5 decades maximum
Readout Marking	10 positions, 0-9
Actuating Force	19 to 29 oz. on detent decades
Actuating Force Variation	4 oz. maximum

¹At room ambient: +25 °C nominal and 50 % relative humidity nominal, except as noted.
NOTE: Terminals 1 & 3 are reversed from illustration for models 3682 and 3684.

Product Dimensions

Model	Dimensions					Weight (Approx.)	
	a	b	c	d	e - .381 (-.015)	oz.	gms.
3681	16.51 (.650)	14.99 (.590)	—	9.91 (.39)	4.19 (.165)	.336	9.5
3682	26.67 (1.050)	25.15 (.99)	10.67 (.42)	11.94 (.47)	8.38 (.330)	.576	16.5
3683	37.08 (1.46)	35.31 (1.39)	18.54 (.73)	11.94 (.47)	4.19 (.165)	.824	23.5
3684	47.50 (1.87)	45.47 (1.79)	30.73 (1.21)	11.94 (.47)	8.38 (.330)	1.072	30.5
3685	57.66 (2.270)	55.63 (2.190)	39.12 (1.540)	11.94 (.47)	4.19 (.165)	1.320	37.5

Model	Dimensions	
	f - .010 (-.254)	g - .010 (-.254)
3681	21.08 (.830)	15.75 (.620)
3682	21.08 (.830)	25.91 (1.020)
3683	21.08 (.830)	36.07 (1.420)
3684	21.08 (.830)	46.23 (1.820)
3685	21.08 (.830)	56.39 (2.220)



Product Dimensions

3680

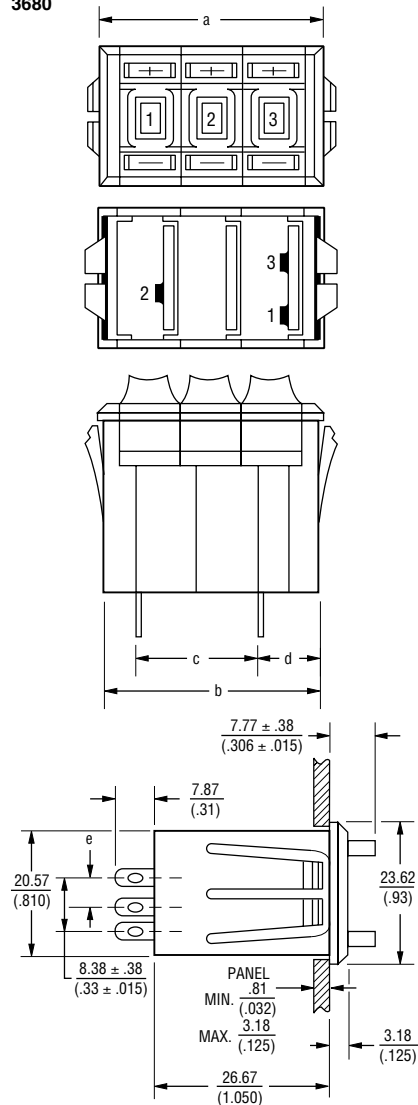

TOLERANCES: EXCEPT WHERE NOTED
 DECIMALS: .XX ± .38 (.015) .XXX ± .13 (.005)
 FRACTIONS: ±1/64
 DIMENSIONS: MM (IN.)

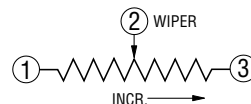

*RoHS Directive 2002/95/EC Jan 27 2003 including Annex
 Specifications are subject to change without notice.
 Customers should verify actual device performance in their specific applications.

3680 Family - Precision Potentiometer

BOURNS®

Recommended Part Numbers

Resistance (Ω)	3681S-1 1 Decade	3682S-1 2 Decade	3683S-1 3 Decade	3684S-1 4 Decade	3685S-1 5 Decade
50	-500L				
100	-101L				
200	-201L				
500	-501L	-501L			
1,000	-102L	-102L	-102L		
2,000	-202L	-202L	-202L		
5,000	-502L	-502L	-502L		
10 K	-103L	-103L	-103L	-103L	
20 K		-203L	-203L	-203L	
50 K		-503L	-503L	-503L	
100 K	-104L	-104L	-104L	-104L	-104L
500 K			-504L	-504L	-504L
1 Meg		-105L	-105L	-105L	-105L

BOLDFACE LISTINGS ARE IN STOCK AND READILY AVAILABLE THROUGH DISTRIBUTION.

FOR OTHER OPTIONS CONSULT FACTORY.

RoHS IDENTIFIER:

L = COMPLIANT

BLANK = NON-COMPLIANT

Данный компонент на территории Российской Федерации

Вы можете приобрести в компании MosChip.

Для оперативного оформления запроса Вам необходимо перейти по данной ссылке:

<http://moschip.ru/get-element>

Вы можете разместить у нас заказ для любого Вашего проекта, будь то серийное производство или разработка единичного прибора.

В нашем ассортименте представлены ведущие мировые производители активных и пассивных электронных компонентов.

Нашей специализацией является поставка электронной компонентной базы двойного назначения, продукции таких производителей как XILINX, Intel (ex.ALTERA), Vicor, Microchip, Texas Instruments, Analog Devices, Mini-Circuits, Amphenol, Glenair.

Сотрудничество с глобальными дистрибьюторами электронных компонентов, предоставляет возможность заказывать и получать с международных складов практически любой перечень компонентов в оптимальные для Вас сроки.

На всех этапах разработки и производства наши партнеры могут получить квалифицированную поддержку опытных инженеров.

Система менеджмента качества компании отвечает требованиям в соответствии с ГОСТ Р ИСО 9001, ГОСТ РВ 0015-002 и ЭС РД 009

Офис по работе с юридическими лицами:

105318, г.Москва, ул.Щербаковская д.3, офис 1107, 1118, ДЦ «Щербаковский»

Телефон: +7 495 668-12-70 (многоканальный)

Факс: +7 495 668-12-70 (доб.304)

E-mail: info@moschip.ru

Skype отдела продаж:

moschip.ru

moschip.ru_4

moschip.ru_6

moschip.ru_9