

SWITCHING REGULATOR CONTROL IC

■ GENERAL DESCRIPTION

The NJM2377 is high speed switching regulator control IC which can operate at low voltage.

The NJM2377 consists of low power oscillation circuit, high precision reference, wide band error amplifier, under voltage lockout circuit, and a totem pole output circuit; which can drive an external Bipolar transistor directly.

The NJM2377 is suitable for any portable system, TFT panel to note PC and especially power supply at video CD.

■ PACKAGE OUTLINE

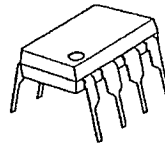

NJM2377D



NJM2377M



NJM2377V

■ FEATURES

- PWM Type Switching Regulator Control
- Operating Voltage (2.7~18V)
- Wide Oscillator Range (10~500kHz)
- ON/OFF Maximum Duty Cycle (Ton:Toff=9:1)
- Totem Pole Output
- Soft-Start Function
- Under Voltage Lockouts (U. V. L. O.)
- Bipolar Technology
- Package Outline DIP8, DMP8, SSOP8

■ BLOCK DIAGRAM

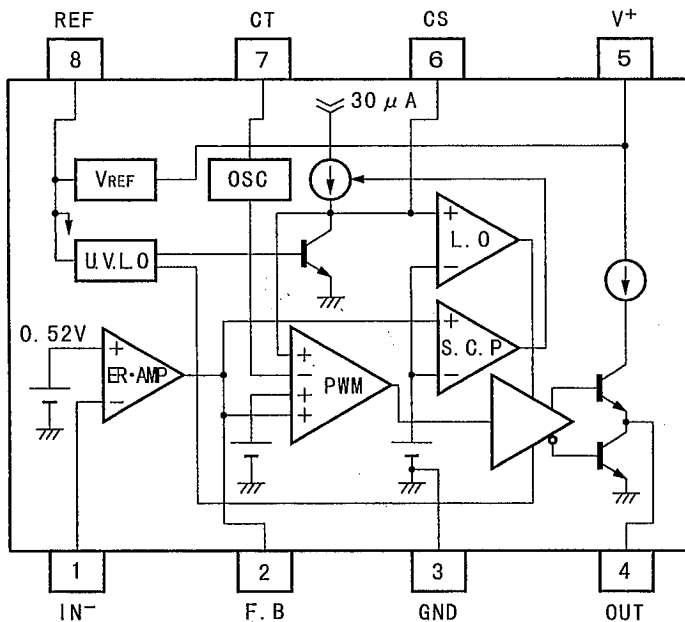

- PIN FUNCTION
1. IN⁻
 2. F. B
 3. GND
 4. OUT
 5. V⁺
 6. CS
 7. CT
 8. REF

■ ABSOLUTE MAXIMUM RATINGS (Ta=25°C)

PARAMETER	SYMBOL	RATINGS	UNIT
Input Voltage	V ⁺	18	V
Reference Output Current	I _o	±50	mA
Power Dissipation	P _D	(DIP8) 700 (DMP8) 300 (SSOP8) 250	mW
Operating Temperature Range	T _{OPR}	-40~+85	°C
Storage Temperature Range	T _{STG}	-50~+150	°C

■ RECOMMENDED OPERATING CONDITIONS (V⁺=3V, Ta=25°C)

PARAMETER	SYMBOL	MIN.	MAX.	UNIT
Operating Voltage	V ⁺	2.7	18	V
Feed Back Resistor	R _{NF}	100	—	k Ω
Oscillator Timing Capacitor	C _T	220	22,000	p F
Oscillator Timing Resistor	R _T	5	100	k Ω
Oscillation Frequency	f _{osc}	10	500	k H z

■ ELECTRICAL CHARACTERISTICS ($V^+=3V$, $R_T=39k\Omega$, $C_T=470pF$, $T_a=25^\circ C$)

REFERENCE VOLTAGE BLOCK

PARAMETER	SYMBOL	TEST CONDITION	MIN.	TYP.	MAX.	UNIT
Output Voltage	V_{REF}	$I_{OR}=1mA$	1.47	1.50	1.53	V
Line Regulation	$\Delta V_o - V_{IN}$	$V^+=2.7\sim 18V$, $I_{OR}=1mA$	—	3.8	11.5	mV
Load Regulation	$\Delta V_o - I_o$	$I_{OR}=0.1\sim 5.0mA$	—	5	30	mA

OSCILLATOR BLOCK

PARAMETER	SYMBOL	TEST CONDITION	MIN.	TYP.	MAX.	UNIT
Oscillation Frequency	f_{osc}	$C_T=470pA$, $R_T=39k\Omega$	80	100	120	kHz
Oscillate Fluctuations1 (Line Fluctuations)	f_{dv}	$V^+=2.7\sim 18V$, $I_{OR}=1mA$	—	1	—	%
Oscillate Fluctuations2 (Temp. Fluctuations)	f_{dt}	$T_a=-40\sim +85^\circ C$	—	5	—	%

ERROR AMPLIFIER BLOCK

PARAMETER	SYMBOL	TEST CONDITION	MIN.	TYP.	MAX.	UNIT
Reference Voltage	V_B		0.51	0.52	0.53	V
Input Bias Current	I_B		—	5	100	nA
Open Loop Gain	A_v		—	90	—	dB
Gain Band width Product	G_B		—	1.0	—	MHz
Maximum Output Voltage (F. B Pin)	V_{OM+} V_{OM-}	$R_{NF}=100k\Omega$, $I_{N-} Pin=0V$ $R_{NF}=100k\Omega$, $I_{N-} Pin=1V$	1.9	2.2	2.4	V
Output Source Current (F. B Pin)	I_{OM+}	$V_{OM}=1V$, $I_{N-} Pin=0V$	—	—	200	mA
			40	85	200	μA

PWM COMPARABLE BLOCK

PARAMETER	SYMBOL	TEST CONDITION	MIN.	TYP.	MAX.	UNIT
Input Bias Voltage (F. B Pin)	V_{TH0}	duty·cycle=0%	—	0.45	0.55	V
Input Threshold Voltage (F. B Pin)	V_{TH80}	duty·cycle=80%	—	1.05	—	V
Maximum Duty Cycle	αM	F. B Pin=1.2V $C_T=470pF$, $R_T=39k\Omega$	80	90	—	%

SOFT START CIRCUIT BLOCK

PARAMETER	SYMBOL	TEST CONDITION	MIN.	TYP.	MAX.	UNIT
Input Bias Current (GS Pin)	I_{BCS}		—	250	650	nA
Input Threshold Voltage (GS Pin)	V_{THCS0}	duty·cycle=0% F. B Pin=1.2V	—	0.25	0.35	V
Input Threshold Voltage (GS Pin)	V_{THCS80}	duty·cycle=80% F. B Pin=1.2V	—	0.79	—	V

6

■ ELECTRICAL CHARACTERISTICS ($V^+=3V$, $R_T=39k\Omega$, $C_T=470pF$, $T_a=25^\circ C$)

SHORT CIRCUIT PROTECTION

PARAMETER	SYMBOL	TEST CONDITION	MIN.	TYP.	MAX.	UNIT
Input Threshold Voltage (F.B Pin)	V_{THPC}		1.30	1.50	1.80	V
Charge Current (CS Pin)	I_{CHG}	CS Pin=0V, F.B Pin=2V	10	30	50	μA
Latch mode Threshold Voltage (CS Pin)	V_{THLA}		1.20	1.50	1.80	V

UNDER VOLTAGE LOCKOUT

PARAMETER	SYMBOL	TEST CONDITION	MIN.	TYP.	MAX.	UNIT
ON Threshold Voltage	V_{THON}		—	1.95	—	V
OFF Threshold Voltage	V_{THOFF}		—	1.78	—	V
Hysteresis Voltage	V_{HYS}		60	170	—	mV

OUTPUT BLOCK

PARAMETER	SYMBOL	TEST CONDITION	MIN.	TYP.	MAX.	UNIT
H-Output Voltage (OUT Pin)	V_{OH}	$R_L=10k\Omega$	1.7	2.0	—	V
L-Output Voltage (OUT Pin)	V_{OL}	Output Sink Current=20mA	—	0.25	0.65	V
Output Source Current (OUT Pin)	I_{SOURCE}	OUT Pin=0V	23	35	—	mA

GENERAL CHARACTERISTIC

PARAMETER	SYMBOL	TEST CONDITION	MIN.	TYP.	MAX.	UNIT
Quiescent Current	I_{CCLA}	Latch Mode, CS Pin=1.8V	—	1.7	2.4	mA
Average Quiescent Current	I_{CCAV}	$R_L=\infty$, duty-cycle=50%	—	5.0	6.8	mA

■ TYPICAL APPLICATION

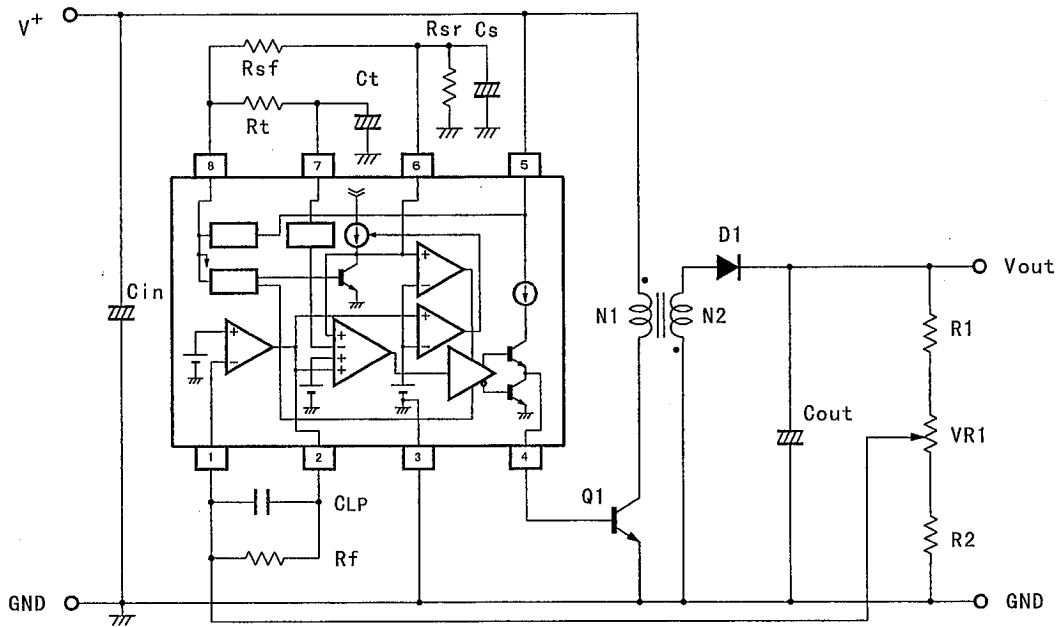

TYPICAL CHARACTERISTICS

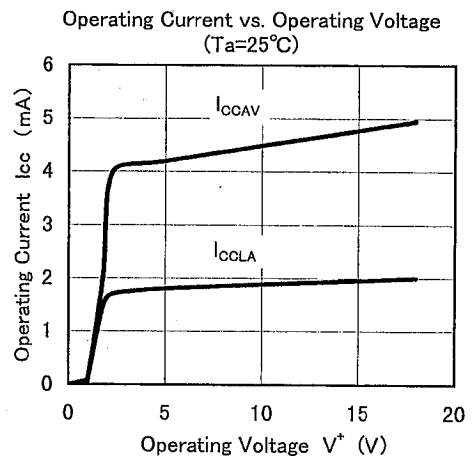
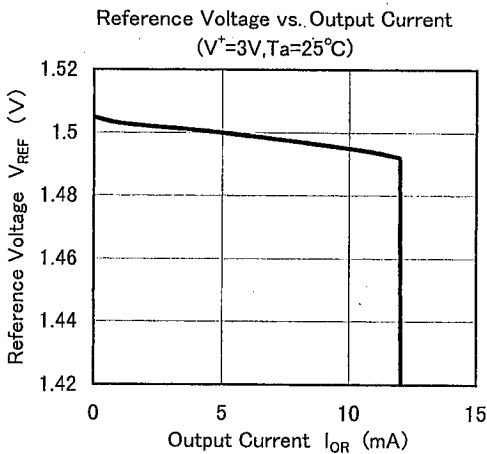
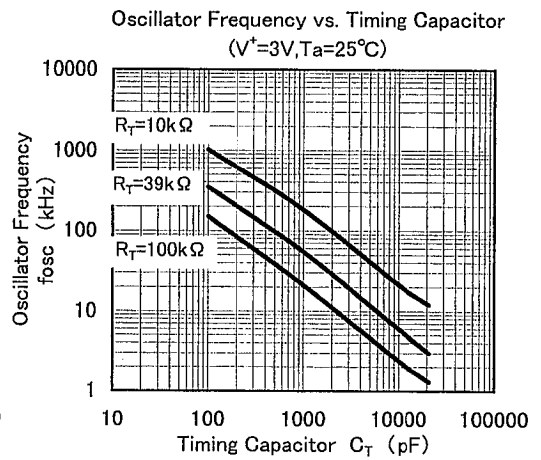
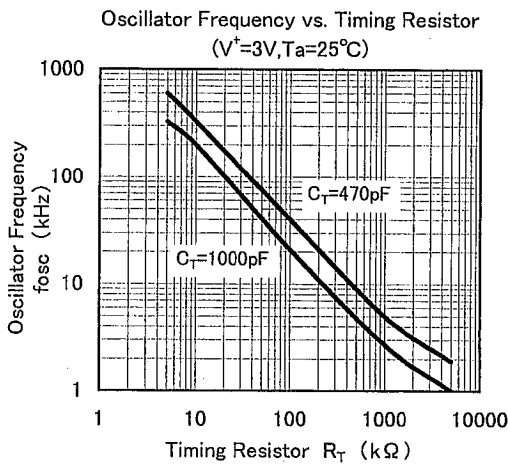
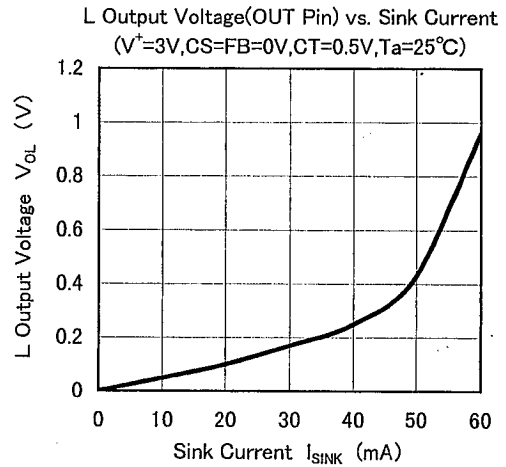
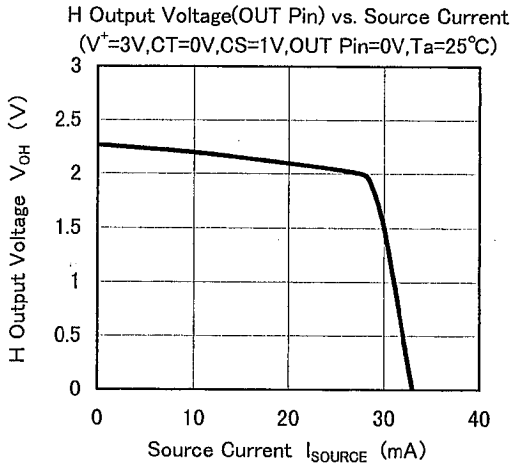

■ TYPICAL CHARACTERISTICS

Maximum Duty Cycle vs. Oscillator Frequency
($V^+ = 3V$)

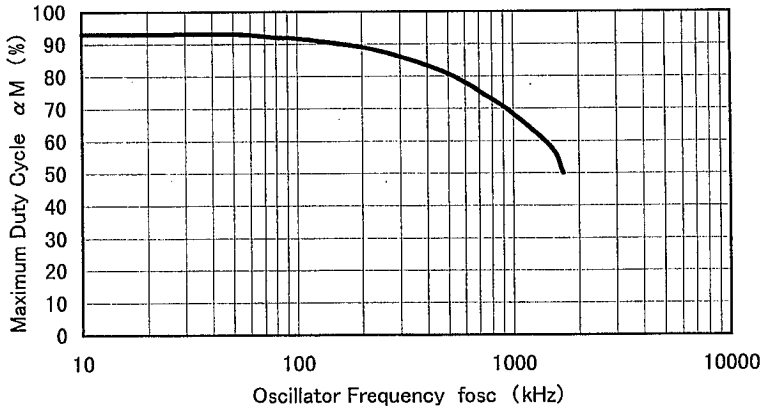

Duty Cycle vs. CS Pin Voltage
($V^+ = 3V$)

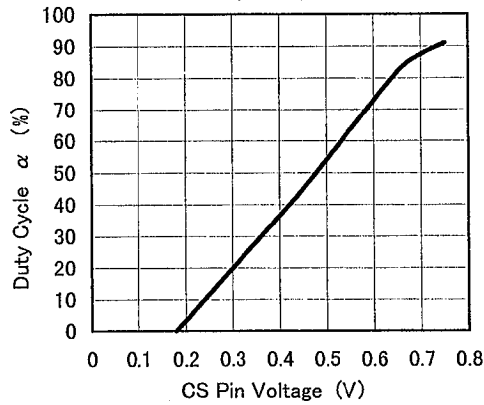

Quiescent Current (Latch Mode) vs. Temperature
($V^+ = 3V, CS = 1.8V$)

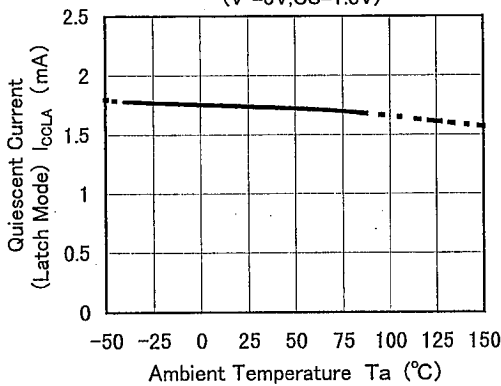

Average Quiescent Current vs. Temperature
($V^+ = 3V, R_L = \infty, \text{duty cycle} = 50\%$
 $R_T = 39k\Omega, C_T = 470pF$)

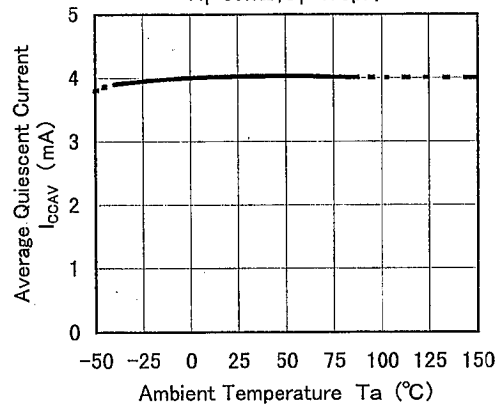

6

TYPICAL CHARACTERISTICS

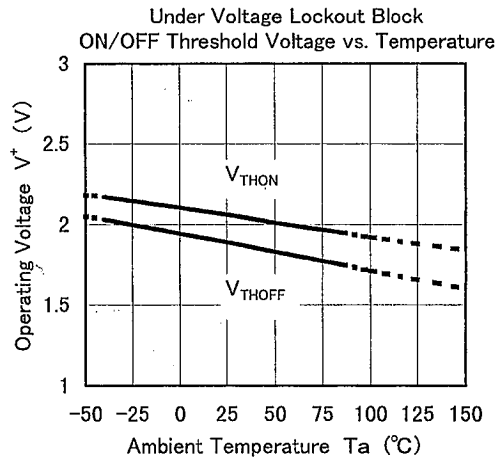
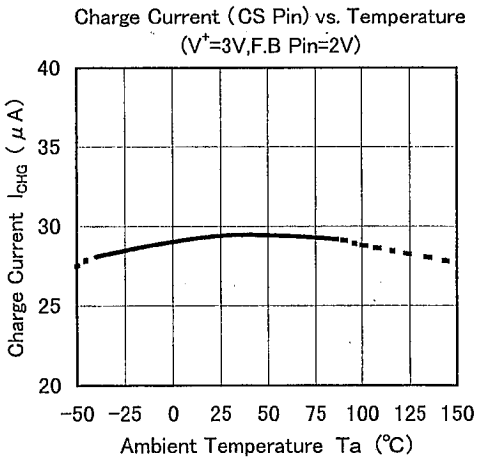
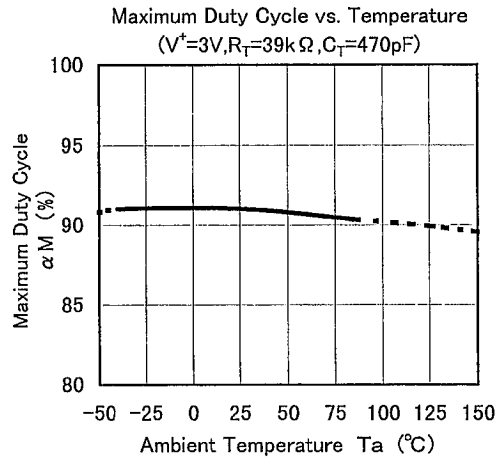
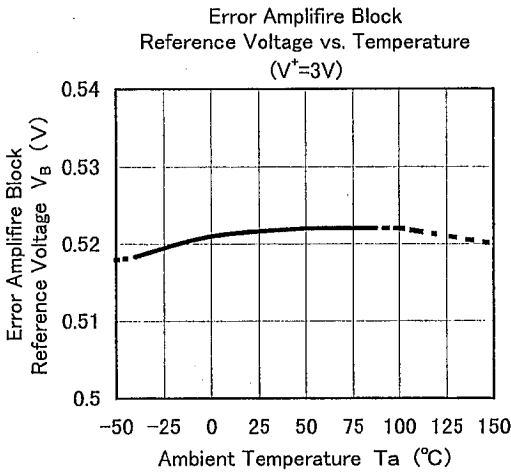
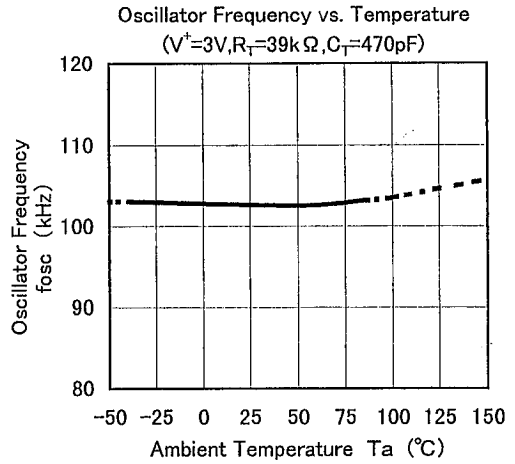
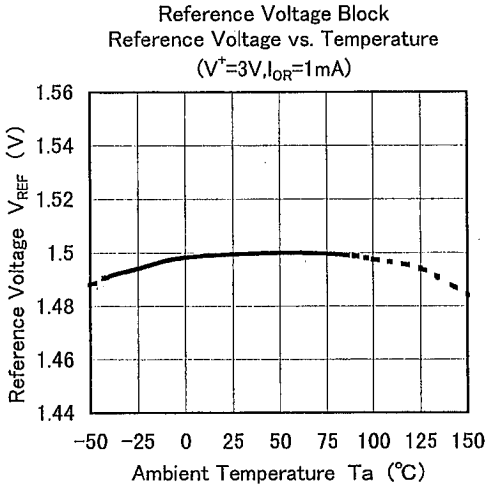

■ TYPICAL CHARACTERISTICS

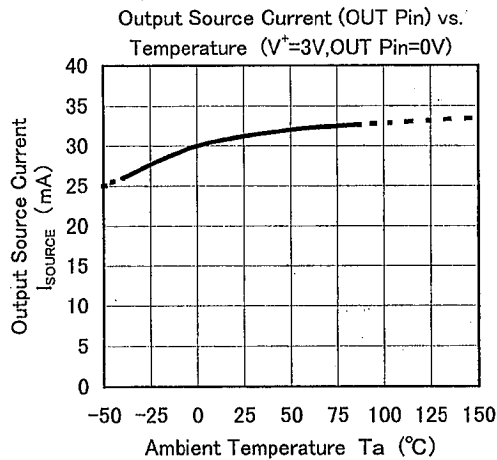
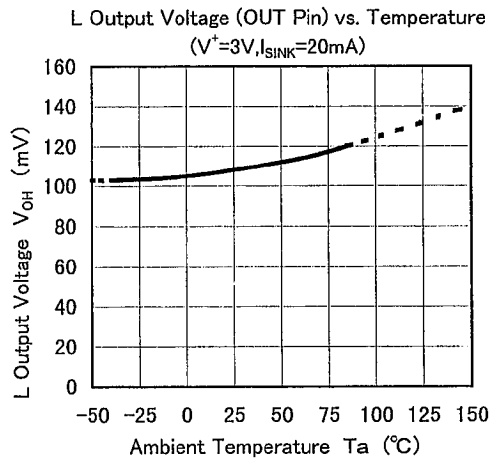
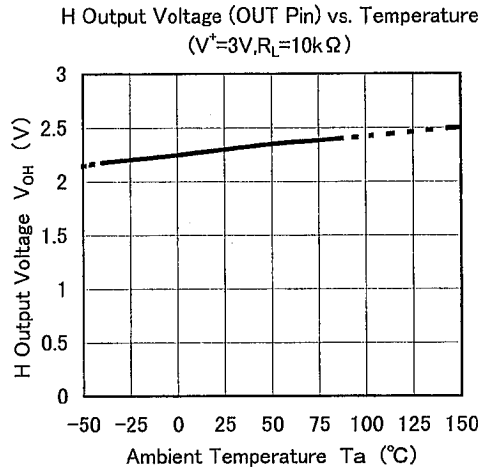

MEMO

[CAUTION]

The specifications on this databook are only given for information, without any guarantee as regards either mistakes or omissions. The application circuits in this databook are described only to show representative usages of the product and not intended for the guarantee or permission of any right including the industrial rights.

Данный компонент на территории Российской Федерации

Вы можете приобрести в компании MosChip.

Для оперативного оформления запроса Вам необходимо перейти по данной ссылке:

<http://moschip.ru/get-element>

Вы можете разместить у нас заказ для любого Вашего проекта, будь то серийное производство или разработка единичного прибора.

В нашем ассортименте представлены ведущие мировые производители активных и пассивных электронных компонентов.

Нашей специализацией является поставка электронной компонентной базы двойного назначения, продукции таких производителей как XILINX, Intel (ex.ALTERA), Vicor, Microchip, Texas Instruments, Analog Devices, Mini-Circuits, Amphenol, Glenair.

Сотрудничество с глобальными дистрибьюторами электронных компонентов, предоставляет возможность заказывать и получать с международных складов практически любой перечень компонентов в оптимальные для Вас сроки.

На всех этапах разработки и производства наши партнеры могут получить квалифицированную поддержку опытных инженеров.

Система менеджмента качества компании отвечает требованиям в соответствии с ГОСТ Р ИСО 9001, ГОСТ РВ 0015-002 и ЭС РД 009

Офис по работе с юридическими лицами:

105318, г.Москва, ул.Щербаковская д.3, офис 1107, 1118, ДЦ «Щербаковский»

Телефон: +7 495 668-12-70 (многоканальный)

Факс: +7 495 668-12-70 (доб.304)

E-mail: info@moschip.ru

Skype отдела продаж:

moschip.ru

moschip.ru_4

moschip.ru_6

moschip.ru_9