

EAO – Your Expert Partner for
Human Machine Interfaces

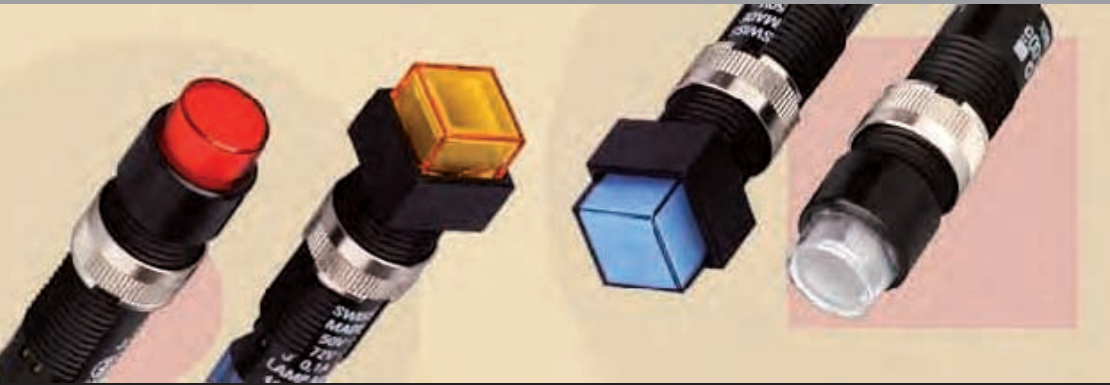

EAO Product Information

Series 19



| | |
|-------------------------------|----|
| Description | 3 |
| Product Assembly | 4 |
| Devices raised mounting | 5 |
| Accessories..... | 6 |
| Technical Data..... | 9 |
| Application guidelines..... | 11 |
| Drawings..... | 12 |
| Index..... | 15 |

Product Information

General notes

The series contains indicators and illuminated pushbuttons with maintained and momentary action and one contact which may be normally closed or normally open (snap-action element for closing). The illuminated pushbuttons are fitted with snap-action or low-level switching systems.

The front dimensions are 9 x 9 mm or 9 mm dia.

Mounting

Mounting from the front through the mounting hole is assured even when the wiring has already been attached.

The units are equipped with soldering/plug-in terminals.

Lenses

The flat lenses, made of polycarbonate, are obtainable in various colours. The transparent lens is available with translucent or transparent support.

Marking

A limited amount of marking can be provided.

Illumination

Perfect illumination of the different coloured lenses is assured by filament lamps Bi-Pin T1 longlife (6 ... 24 V) or LED Bi-Pin T1. LED are available in the colours white, red, yellow, orange and green.

Luminosity and wave length scattering caused by the technology used in the LED manufacturing processes may lead to visual differences in our products.

Position indication

The status of a maintained action switch can be determined by the position of the lens.

Specimen order

Indicator :

- Indicator actuator, 9 mm dia., soldering terminal 19-030.005

Essential accessories :

- Lens plastic blue, transparent, flush, 9 mm dia. 19-931.6
- Single-LED, T1 Bi-Pin, 3.6 VDC, weiss 10-2603.3179C

*We reserve the right to modify technical data
All dimensions in mm*

Indicator, raised mounting

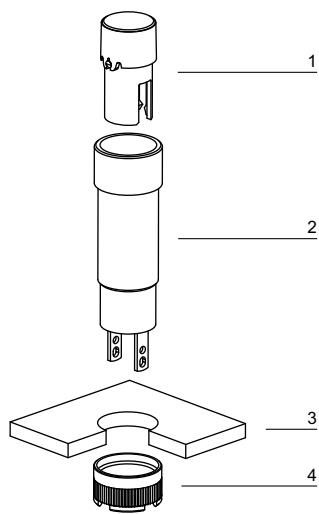

- 1 Lens
- 2 Switch housing
- 3 Front plate
- 4 Fixing nut

Pushbutton illuminative, raised mounting

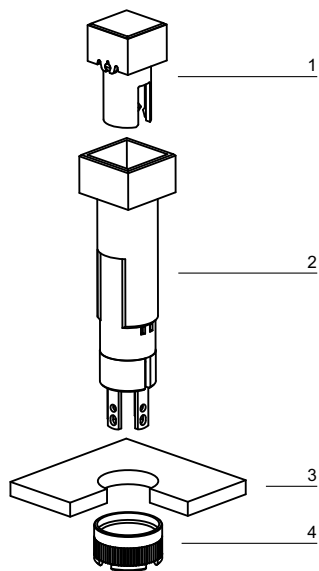



- 1 Lens
- 2 Switch housing
- 3 Front plate
- 4 Fixing nut

Indicator actuator



Essential Accessories:

-  Lens page 6
-  Single-LED page 7

| | Front protection | Terminals | 9 x 9 mm Typ-Nr. | Ø 9 mm Typ-Nr. | Component layout | Mounting dimensions | Technical drawing | Circuit drawing | |
|---|------------------|-----------|-------------------|-------------------|------------------|---------------------|-------------------|-----------------|-------|
| Indicator actuator Mounting depth : 25 mm | IP 40 | S2 | 19-050.005 | 19-030.005 | 1 | 1 | 1 | 1 | 0.001 |
| Mounting depth : 33 mm | IP 40 | S2 | 19-051.005 | 19-031.005 | 1 | 1 | 3 | 1 | 0.002 |



Terminals: S2 = Soldering terminal (also pluggable 2.0 x 0.5 mm)

Component layout from page 12, Mounting dimensions from page 12, Technical drawing from page 13, Circuit drawing from page 14

Illuminated pushbutton actuator



Essential Accessories:

-  Lens page 6
-  Single-LED page 7

| | Front protection | Switching system | Contact material | Contacts | Switching action | Terminals | 9 x 9 mm Typ-Nr. | Ø 9 mm Typ-Nr. | Component layout | Mounting dimensions | Technical drawing | Circuit drawing | |
|--|------------------|------------------|------------------|----------|------------------|-----------|-------------------|-------------------|------------------|---------------------|-------------------|-----------------|-------|
| Illuminated pushbutton actuator | IP 40 | LL | Au | 1 NC | MA | S2 | 19-482.035 | 19-472.035 | 2 | 1 | 2 | 2 | 0.002 |
| | | | | | M | S2 | 19-452.035 | 19-432.035 | 2 | 1 | 2 | 4 | 0.002 |
| | | | | 1 NO | MA | S2 | 19-481.035 | 19-471.035 | 2 | 1 | 2 | 3 | 0.002 |
| | | | | | M | S2 | 19-451.035 | 19-431.035 | 2 | 1 | 2 | 5 | 0.002 |
| | | SA | Au | 1 NO | MA | S2 | 19-289.035 | 19-279.035 | 2 | 1 | 2 | 3 | 0.002 |
| | | | | | M | S2 | 19-159.035 | 19-139.035 | 2 | 1 | 2 | 5 | 0.002 |
| | | | Ag | 1 NO | MA | S2 | 19-289.015 | 19-279.015 | 2 | 1 | 2 | 3 | 0.002 |
| | | | | | M | S2 | 19-159.015 | 19-139.015 | 2 | 1 | 2 | 5 | 0.002 |

Switching system: LL = Low level switching element, SA = Snap-action switching element

Contact material: Au = Gold, Ag = Silver

Contacts: NC = Normally closed, NO = Normally open

Switching action: MA = Maintained action, M = Momentary action

Terminals: S2 = Soldering terminal (also pluggable 2.0 x 0.5 mm)

Component layout from page 12, Mounting dimensions from page 12, Technical drawing from page 13, Circuit drawing from page 14

Front

Lens

| | Lens | ∅ 9 x 9 mm Typ-Nr. | ∅ 9 mm Typ-Nr. |  |
|--|--------------------------------------|-----------------------|-------------------|---|
| Lens illuminative, holder translucent | Plastic flush transparent blue | 19-951.6 | 19-931.6 | 0.001 |
| | Plastic flush transparent green | 19-951.5 | 19-931.5 | 0.001 |
| | Plastic flush transparent red | 19-951.2 | 19-931.2 | 0.001 |
| | Plastic flush transparent white | 19-951.9 | 19-931.9 | 0.001 |
| | Plastic flush transparent yellow | 19-951.4 | 19-931.4 | 0.001 |
| illuminative (not recommended for film insert), holder transparent | Plastic flush transparent blue | 19-952.6 | 19-932.6 | 0.001 |
| | Plastic flush transparent colourless | 19-952.7 | 19-932.7 | 0.001 |
| | Plastic flush transparent green | 19-952.5 | 19-932.5 | 0.001 |
| | Plastic flush transparent red | 19-952.2 | 19-932.2 | 0.001 |
| | Plastic flush transparent yellow | 19-952.4 | 19-932.4 | 0.001 |
| non-illuminative | Plastic flush opaque black | 19-951.0 | 19-931.0 | 0.001 |
| | Plastic flush opaque grey | 19-951.8 | 19-931.8 | 0.001 |



Blind plug

| | Blind plug | ∅ 9 x 9 mm Typ-Nr. | ∅ 9 mm Typ-Nr. | Mounting dimensions |  |
|-------------------|---------------|-----------------------|-------------------|---------------------|---|
| Blind plug | Plastic black | 19-948.0 | 19-949.0 | 1 | 0.001 |



Mounting dimensions from page 12

Backside

PCB plug-in base

| | Terminals | Typ-Nr. | Component layout | Technical drawing |  |
|---------------------------------------|-----------|---------------|------------------|-------------------|---|
| PCB plug-in base Pins axial | P | 19-940 | 3 | 4 | 0.001 |
| Pins bent at right-angles | P | 19-941 | 4 | 5 | 0.001 |



Terminals: P = PCB terminal

Component layout from page 12, Technical drawing from page 13

Flat receptacle

| | Typ-Nr. |  |
|--|---------------|---|
| Flat receptacle 2.0 x 0.5 mm | 31-945 | 0.001 |



Insulation sleeve

| | Typ-Nr. |  |
|--|---------------|---|
| Insulation sleeve for Flat receptacle 31-945 | 31-928 | 0.001 |



Illumination

Filament lamp

| | Socket | Operating voltage/-current | Typ-Nr. |  |
|--|-----------|----------------------------|---------------------|---|
| Filament lamp max. PIN length 5 mm | T1 Bi-Pin | 12 VAC/DC, 25 mA | 10-1609.1199 | 0.001 |
| | | 24 VAC/DC, 20 mA | 10-1612.1179 | 0.001 |
| | | 6 VAC/DC, 70 mA | 10-1606.1309 | 0.001 |



Single-LED

| | Socket | Light colour | Operating voltage/-current | Typ-Nr. |  |
|---|-----------|--------------|----------------------------|----------------------|---|
| Single-LED max. PIN length 8 mm | T1 Bi-Pin | green | 2.2 VDC, 20 mA | 10-2602.3175C | 0.001 |
| | | red | 2.2 VDC, 20 mA | 10-2602.3172C | 0.001 |
| | | white | 3.6 VDC, 20 mA | 10-2603.3179C | 0.001 |
| | | yellow | 2.2 VDC, 20 mA | 10-2602.3174C | 0.001 |



Multi-LED

| | Socket | Light colour | Operating voltage/-current | Typ-Nr. |  |
|--|-----------|--------------|----------------------------|----------------------|---|
| Multi-LED max. PIN length 5 mm | T1 Bi-Pin | green | 28 VDC, 12 mA | 10-4613.3105B | 0.001 |
| | | orange | 28 VDC, 12 mA | 10-4613.3103B | 0.001 |
| | | red | 28 VDC, 12 mA | 10-4613.3102B | 0.001 |
| | | yellow | 28 VDC, 12 mA | 10-4613.3104B | 0.001 |



Assembling

Fixing nut

| | Typ-Nr. |  kg |
|-------------------------------------|---------------|--|
| Fixing nut Ø 9/M8 x 13 mm | 19-991 | 0.001 |



Dressing tool

| | Typ-Nr. |  kg |
|--|---------------|--|
| Dressing tool for aligning buttons | 19-906 | 0.011 |



Lens remover

| | Typ-Nr. |  kg |
|---------------------|---------------|--|
| Lens remover | 19-910 | 0.002 |



Lamp remover

| | Typ-Nr. |  kg |
|---------------------|---------------|--|
| Lamp remover | 11-906 | 0.003 |



CAUTION
A switching process might be released when replacing the Lamp/LED !

Mounting tool

| | Typ-Nr. |  kg |
|--|---------------|--|
| Mounting tool for Fixing nut long 19-991 | 19-905 | 0.011 |



Actuator with snap-action switching element

Switching system

Single-break, snap-action switching system.
1 normally open contact

Material

Material of contact

Gold plated Silver, Silver plated

Switch housing

Polyetherimide (PEI), self-extinguishing

Actuator housing

Polyphenyleneoxide (PPO), self-extinguishing, colour black

Mechanical characteristics

Terminals

Universal terminal:
Max. wire diameter 2 x 0.8 mm
Max. wire cross-section of stranded cable 1 x 0.75 mm²

Plug-in terminal: 2.0 x 0.5 mm
For these terminals we can also supply a plug-in base which, when soldered on to the board, enables the switch to be plugged in.

Tightening torque

for fixing nut max. 20 Ncm

Actuating force

1.6 N

Actuating travel

2.8 mm ±0.2 mm

Mechanical lifetime

2 million operations

Electrical characteristics

Switch rating

Silver plated:
Max. 50 VAC / 72 VDC, 0.8 A or 50 W
Min. 20 V, 10 mA
Gold plated:
Max. 50 VAC / 72 VDC, 100 mA or 5 W
Min. 100 µV, 50 µA

Electric strength

2500 VAC, 50 Hz, 1 min. between all terminals and earth, as per IEC 60512-2-11

Environmental conditions

Storage temperature

-40 °C ... +85 °C

Service temperature

without illumination -25 °C ... +65 °C
with incandescent lamp -25 °C ... +45 °C
with LED -25 °C ... +65 °C
for indicators and illuminated pushbuttons mounted as a block, make sure the heat can escape freely

Protection degree

IP 40 front side, as per IEC 60529

Actuator with low level switching element

Switching system

This low-level switching system was designed for switching low powers in electronic circuits. The switching system assures reliable switching of loads.
Single-break momentary contact, as normally open or normally closed with 4 independent points of contact.
Special features are the long life, extremely short rebound time and stable contact resistance.
1 normally open or 1 normally closed contact.

Material

Material of contact

Gold plated

Actuator housing

Polyphenyleneoxide (PPO), self-extinguishing, colour black

Mechanical characteristics

Terminals

Universal terminal:
Max. wire diameter 2 x 0.8 mm
Max. wire cross-section of stranded cable 1 x 0.75 mm²

Plug-in terminal: 2.0 x 0.5 mm
For these terminals we can also supply a plug-in base which, when soldered on to the board, enables the switch to be plugged in.

Tightening torque

for fixing nut max. 20 Ncm

Actuating force

1.8 N ±0.3 N

Actuating travel

2.8 mm ±0.2 mm

Rebound time

Typ. <100 µs

Mechanical lifetime

5 million operations

Electrical characteristics

Contact resistance

≤50 mΩ starting value (initial) as per IEC 60512-2-2b

Switch rating

10 µA, 100 µV to 100 mA at 42 VAC/VDC

Electric strength

2500 VAC, 50 Hz, 1 min. between all terminals and earth, as per IEC 60512-2-11

Environmental conditions

Storage temperature

-40 °C ... +85 °C

Service temperature

without illumination -25 °C ... +65 °C
with incandescent lamp -25 °C ... +45 °C
with LED -25 °C ... +65 °C

for indicators and illuminated pushbuttons mounted as a block,
make sure the heat can escape freely

Protection degree

IP 40 front side, as per IEC 60529

Shock resistance

(Single impacts, semi-sinusoidal)

15 g for 11 ms, as per IEC 60512-4-3, IEC 60068-2-27

Suppressor circuits

When switching inductive loads such as relays, DC motors, and DC solenoids, it is always important to absorb surges (e.g. with a diode) to protect the contacts. When these inductive loads are switched off, a counter emf can severely damage switch contacts and greatly shorten lifetime.

Fig. 1 shows an inductive load with a free-wheeling diode connected in parallel. This free-wheeling diode provides a path for the inductor current to flow when the current is interrupted by the switch. Without this free-wheeling diode, the voltage across the coil will be limited only by dielectric breakdown voltages of the circuit or parasitic elements of the coil. This voltage can be kilovolts in amplitude even when nominal circuit voltages are low (e.g. 12 VDC) see Fig. 2.

The free-wheeling diode should be chosen so that the reverse breakdown voltage is greater than the voltage driving the inductive load. The DC blocking voltage (V_R) of the free-wheeling diode can be found in the datasheet of a diode. The forward current should be equal or greater than the maximum current flowing through the load.

To get an efficient protection, the free-wheeling diode must be connected as close as possible to the inductive load!

Switching with inductive load
Fig. 1

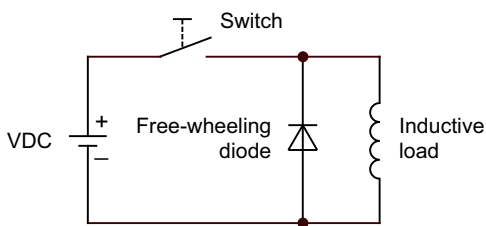

Counter emf
over load without free-wheeling diode
Fig. 2

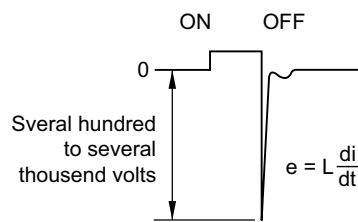

Component layout

1 Indicator actuator page 5

9 x 9 mm Ø9 mm

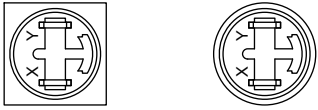

2 Illuminated pushbutton actuator page 5

9 x 9 mm Ø9 mm

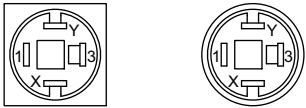

3 PCB plug-in base page 6

Drilling plan (element side)
Through-connection recommended

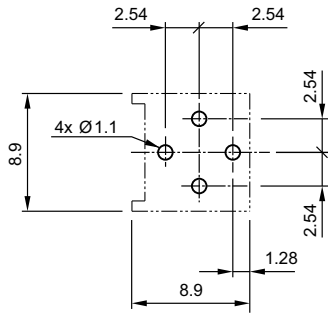

4 PCB plug-in base page 6

Drilling plan (element side)
Through-connection recommended

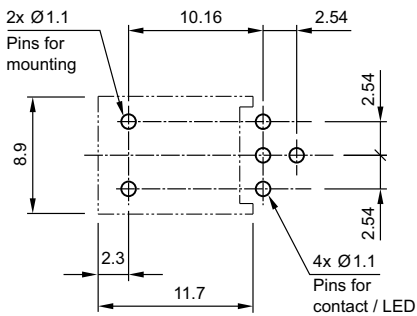

Mounting dimensions

1 Indicator actuator page 5 | Illuminated pushbutton actuator page 5 | Blind plug page 6

9 x 9 mm Ø9 mm

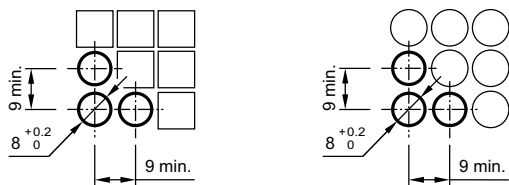

Technical drawing

1 Indicator actuator page 5

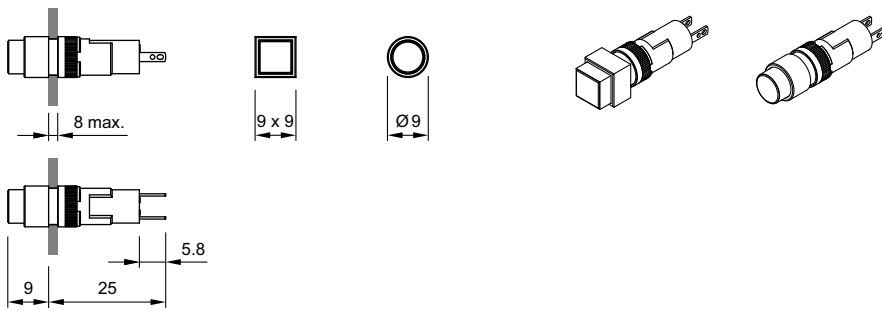

2 Illuminated pushbutton actuator page 5

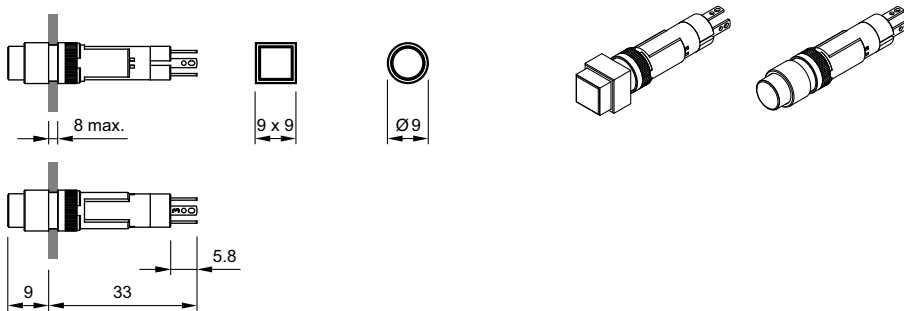

3 Indicator actuator page 5

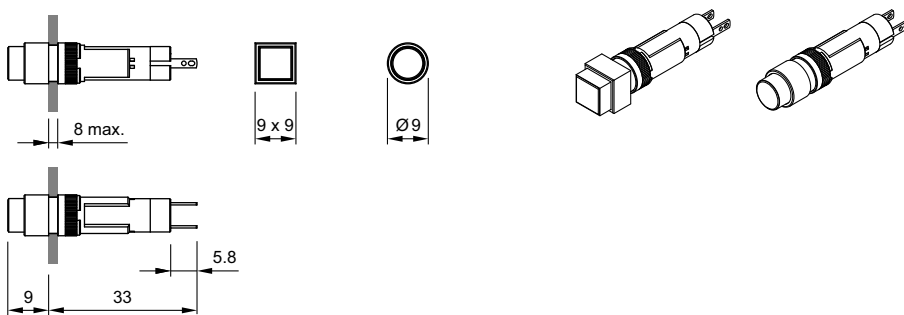

4 PCB plug-in base page 6

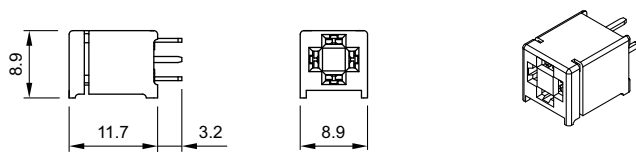

5 PCB plug-in base page 6

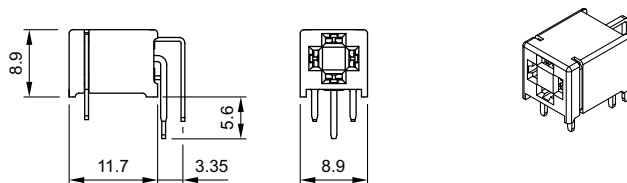

Circuit drawing

1 Indicator actuator page 5



2 Illuminated pushbutton actuator page 5

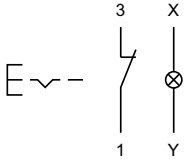

3 Illuminated pushbutton actuator page 5

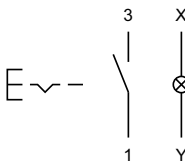

4 Illuminated pushbutton actuator page 5

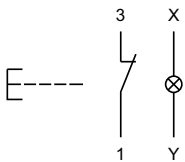

5 Illuminated pushbutton actuator page 5

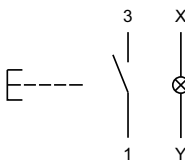

Index from Typ-Nr.

| Typ-Nr. | Page | Typ-Nr. | Page | Typ-Nr. | Page |
|---------------|------|---------|------|---------|------|
| 10-1606.1309 | 7 | 19-991 | 8 | | |
| 10-1609.1199 | 7 | 31-928 | 7 | | |
| 10-1612.1179 | 7 | 31-945 | 7 | | |
| 10-2602.3172C | 7 | | | | |
| 10-2602.3174C | 7 | | | | |
| 10-2602.3175C | 7 | | | | |
| 10-2603.3179C | 7 | | | | |
| 10-4613.3102B | 7 | | | | |
| 10-4613.3103B | 7 | | | | |
| 10-4613.3104B | 7 | | | | |
| 10-4613.3105B | 7 | | | | |
| 11-906 | 8 | | | | |
| 19-030.005 | 5 | | | | |
| 19-031.005 | 5 | | | | |
| 19-050.005 | 5 | | | | |
| 19-051.005 | 5 | | | | |
| 19-139.015 | 5 | | | | |
| 19-139.035 | 5 | | | | |
| 19-159.015 | 5 | | | | |
| 19-159.035 | 5 | | | | |
| 19-279.015 | 5 | | | | |
| 19-279.035 | 5 | | | | |
| 19-289.015 | 5 | | | | |
| 19-289.035 | 5 | | | | |
| 19-431.035 | 5 | | | | |
| 19-432.035 | 5 | | | | |
| 19-451.035 | 5 | | | | |
| 19-452.035 | 5 | | | | |
| 19-471.035 | 5 | | | | |
| 19-472.035 | 5 | | | | |
| 19-481.035 | 5 | | | | |
| 19-482.035 | 5 | | | | |
| 19-905 | 8 | | | | |
| 19-906 | 8 | | | | |
| 19-910 | 8 | | | | |
| 19-931.0 | 6 | | | | |
| 19-931.2 | 6 | | | | |
| 19-931.4 | 6 | | | | |
| 19-931.5 | 6 | | | | |
| 19-931.6 | 6 | | | | |
| 19-931.8 | 6 | | | | |
| 19-931.9 | 6 | | | | |
| 19-932.2 | 6 | | | | |
| 19-932.4 | 6 | | | | |
| 19-932.5 | 6 | | | | |
| 19-932.6 | 6 | | | | |
| 19-932.7 | 6 | | | | |
| 19-940 | 6 | | | | |
| 19-941 | 6 | | | | |
| 19-948.0 | 6 | | | | |
| 19-949.0 | 6 | | | | |
| 19-951.0 | 6 | | | | |
| 19-951.2 | 6 | | | | |
| 19-951.4 | 6 | | | | |
| 19-951.5 | 6 | | | | |
| 19-951.6 | 6 | | | | |
| 19-951.8 | 6 | | | | |
| 19-951.9 | 6 | | | | |
| 19-952.2 | 6 | | | | |
| 19-952.4 | 6 | | | | |
| 19-952.5 | 6 | | | | |
| 19-952.6 | 6 | | | | |
| 19-952.7 | 6 | | | | |

| | |
|----------------|---|
| | EAO AG |
| | Tannwaldstrasse 88 4601 Olten, Switzerland |
| E-mail | info@eao.com |
| Website | www.eao.com |
| | Austria |
| Phone | +49 201 85 87 0 |
| Fax | +49 201 85 87 210 |
| E-mail | sales.ede@eao.com |
| | Belgium |
| Phone | +32 3 777 82 36 |
| Fax | +32 3 777 84 19 |
| E-mail | sales.ebl@eao.com |
| | China |
| Phone | +852 27 86 91 41 |
| Fax | +852 27 86 95 61 |
| E-mail | sales.ehk@eao.com |
| | France |
| Phone | +33 1 64 43 37 37 |
| Fax | +33 1 64 43 37 49 |
| E-mail | sales.esa@eao.com |
| | Germany |
| Phone | +49 201 85 87 0 |
| Fax | +49 201 85 87 210 |
| E-mail | sales.ede@eao.com |
| | Italy |
| Phone | +39 035 481 0189 |
| Fax | +39 035 481 3786 |
| E-mail | sales.eit@eao.com |
| | Japan |
| Phone | +81 3 5444 5411 |
| Fax | +81 3 5444 0345 |
| E-mail | sales.esj@eao.com |
| | Netherlands |
| Phone | +31 78 653 17 00 |
| Fax | +31 78 653 17 99 |
| E-mail | sales.enl@eao.com |
| | Sweden |
| Phone | +46 8 683 86 60 |
| Fax | +46 8 724 29 12 |
| E-mail | sales.esw@eao.com |
| | Switzerland |
| Phone | +41 62 388 95 00 |
| Fax | +41 62 388 95 55 |
| E-mail | sales.ech@eao.com |
| | United Kingdom |
| Phone | +44 1444 236 000 |
| Fax | +44 1444 236 641 |
| E-mail | sales.euk@eao.com |
| | USA |
| Phone | +1 203 877 4577 |
| Fax | +1 203 877 3694 |
| E-mail | sales.eus@eao.com |
| | Other Countries |
| Phone | +41 62 286 92 10 |
| Fax | +41 62 296 21 62 |
| E-mail | info@eao.com |

Данный компонент на территории Российской Федерации

Вы можете приобрести в компании MosChip.

Для оперативного оформления запроса Вам необходимо перейти по данной ссылке:

<http://moschip.ru/get-element>

Вы можете разместить у нас заказ для любого Вашего проекта, будь то серийное производство или разработка единичного прибора.

В нашем ассортименте представлены ведущие мировые производители активных и пассивных электронных компонентов.

Нашей специализацией является поставка электронной компонентной базы двойного назначения, продукции таких производителей как XILINX, Intel (ex.ALTERA), Vicor, Microchip, Texas Instruments, Analog Devices, Mini-Circuits, Amphenol, Glenair.

Сотрудничество с глобальными дистрибьюторами электронных компонентов, предоставляет возможность заказывать и получать с международных складов практически любой перечень компонентов в оптимальные для Вас сроки.

На всех этапах разработки и производства наши партнеры могут получить квалифицированную поддержку опытных инженеров.

Система менеджмента качества компании отвечает требованиям в соответствии с ГОСТ Р ИСО 9001, ГОСТ РВ 0015-002 и ЭС РД 009

Офис по работе с юридическими лицами:

105318, г.Москва, ул.Щербаковская д.3, офис 1107, 1118, ДЦ «Щербаковский»

Телефон: +7 495 668-12-70 (многоканальный)

Факс: +7 495 668-12-70 (доб.304)

E-mail: info@moschip.ru

Skype отдела продаж:

moschip.ru

moschip.ru_4

moschip.ru_6

moschip.ru_9