

MODULAR CONNECTORS

CL 222 TM

Wire Lead Jack Type

●TM1R-616B44-*

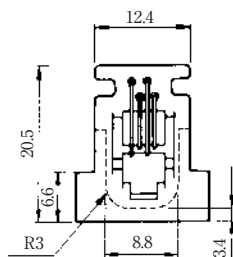
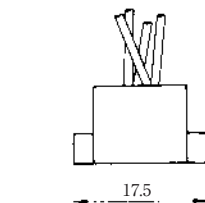
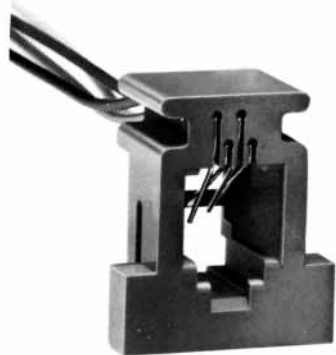

CL No.	Part No.	RoHS
222-4465-0	TM1R-616B44-35S-150M	YES

Color	L (mm)
Yellow	150
Green	150
Red	150
Black	150

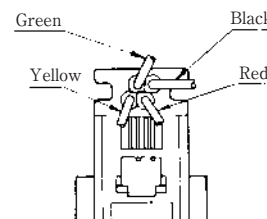
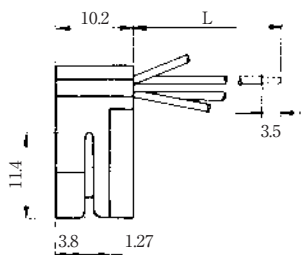

Note: Standard finish color is gray.

●TM1R-616P44-*

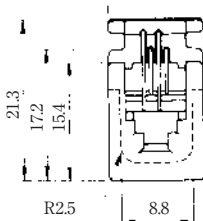
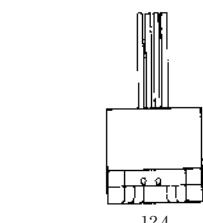
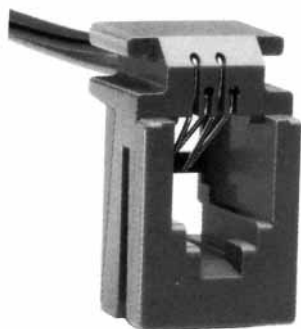

CL No.	Part No.	RoHS
222-4466-2	TM1R-616P44-35S-150M	YES

Color	L (mm)
Yellow	150
Green	150
Red	150
Black	150

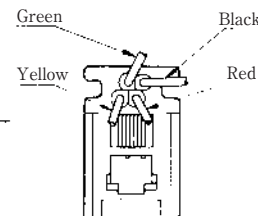
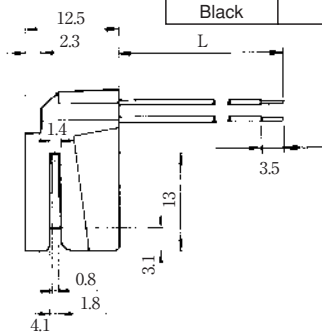

Note: Standard finish color is gray.

●TM1R-616M44-*

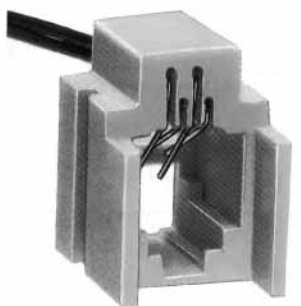

CL No.	Part No.	RoHS
222-4451-5	TM1R-616M44-35S-70M	YES

Color	L (mm)
Yellow	70
Green	70
Red	70
Black	70

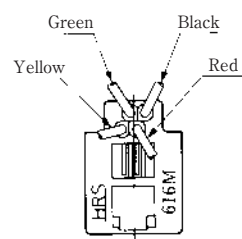
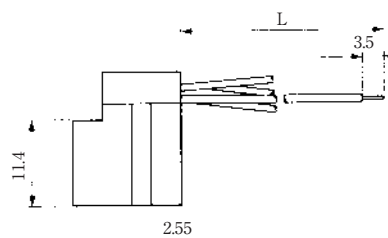

Note: Standard finish color is gray.

MODULAR CONNECTORS

CL 222 TM

TM1R-616W44-*

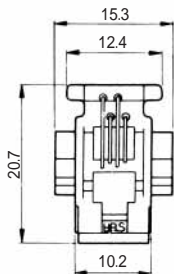
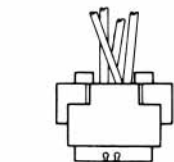
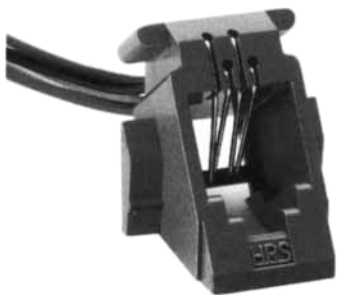

CL No.	Part No.	RoHS
222-4441-1	TM1R-616W44-4S-150M	YES

Color	L (mm)
Yellow	150
Green	150
Red	150
Black	150



Note: Standard finish color is gray.

TM2RD-F44-*

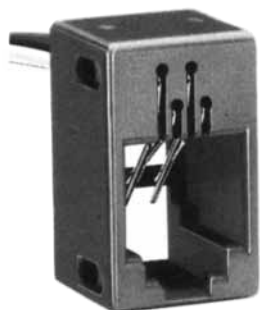

CL No.	Part No.	RoHS
222-4467-5	TM2RD-F44-4S-150M	YES

Color	L (mm)
Yellow	150
Green	150
Red	150
Black	150

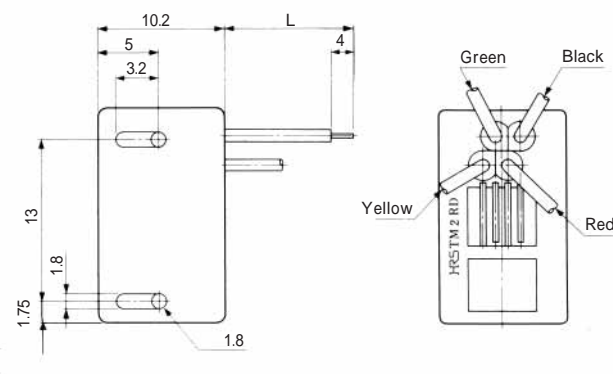

Note: Standard finish color is warm gray.

TM2RDA-F44-*

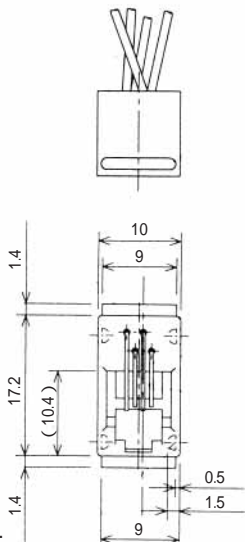
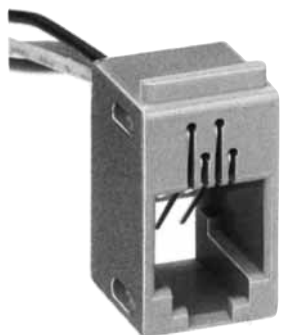

CL No.	Part No.	RoHS
CL222-4440-9	TM2RDA-F44-4S-150M	YES

Color	L (mm)
Yellow	150
Green	150
Red	150
Black	150

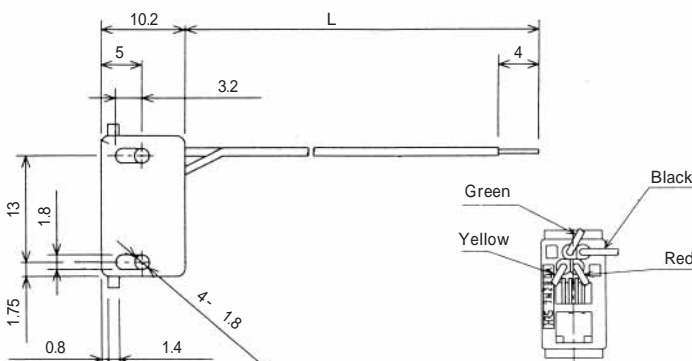

Note: Standard finish color is warm gray.

MODULAR CONNECTORS

CL 222 TM

TM6RA-144- *

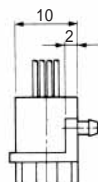
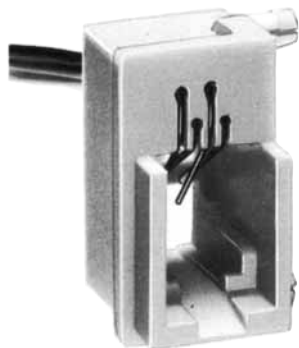

CL No.	Part No.	RoHS
222-4474-0	TM6RA-144-35S-150M	YES

Color	L (mm)
Yellow	150
Green	150
Red	150
Black	150

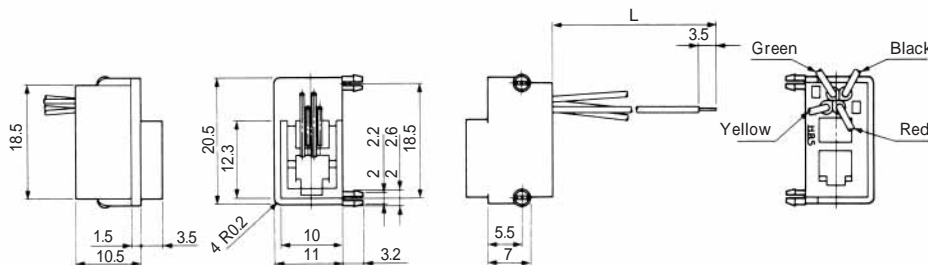

Note: Standard finish color is ash gray.

TM1RV-623K66- *
 TM1RV-623K64- *
 TM1RV-623K62- *

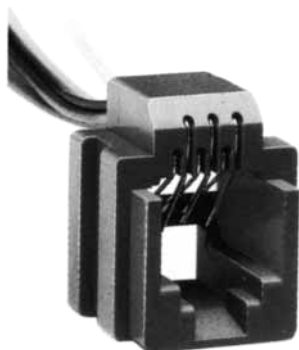

CL No.	Part No.	RoHS
222-4307-9	TM1RV-623K66-4S-150M	YES

Color	L (mm)
White	150
Yellow	150
Green	150
Red	150
Black	150
Blue	150

Color	L (mm)
Yellow	150
Green	150
Red	150
Black	150

CL No.	Part No.	RoHS
222-4470-0	TM1RV-623K62-4S-150M	YES

Color	L (mm)
Green	150
Red	150

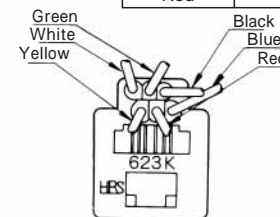
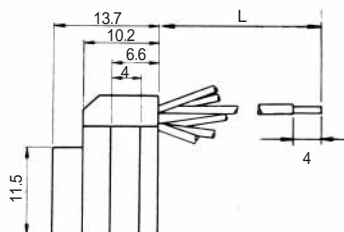
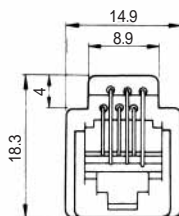

Note1: Standard finish color is gray.

Note2: The drawing is shown sample of TM1RV-623K66- *

TM1RV-623P66- *
 TM1RV-623P64- *

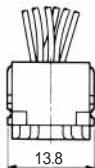
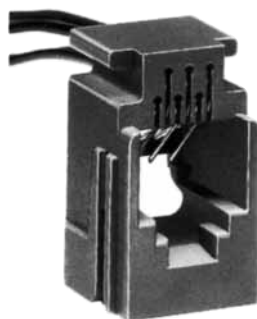

CL No.	Part No.	RoHS
222-4471-2	TM1RV-623P66-35S-150M	YES

Color	L (mm)
White	150
Black	150
Red	150
Green	150
Yellow	150
Blue	150

CL No.	Part No.	RoHS
222-4425-5	TM1RV-623P64-35S-150M	YES

Color	L (mm)
Black	150
Red	150
Green	150
Yellow	150

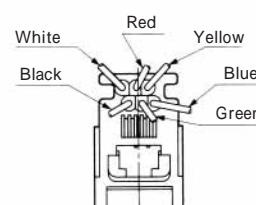
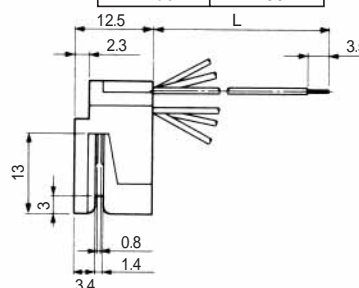
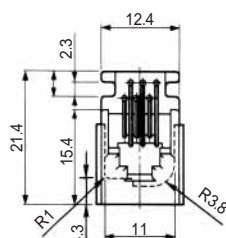

Note1: Standard finish color is gray.

Note2: The drawing is shown sample of TM1RV-623P66- *

MODULAR CONNECTORS

CL 222 TM

●TM7RV-66-*

CL No.	Part No.	RoHS
222-4472-5	TM7RV-A66-35S-150M	YES

Color	L (mm)
White	150
Yellow	150
Green	150
Red	150
Black	150
Blue	150

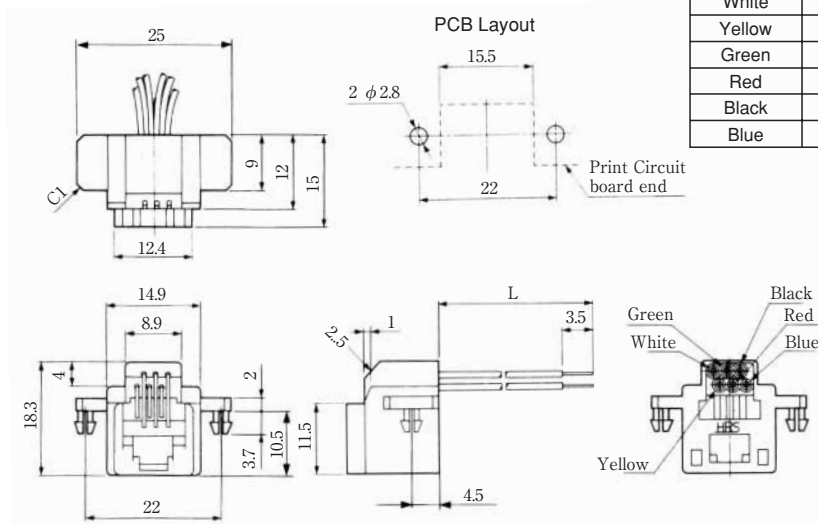
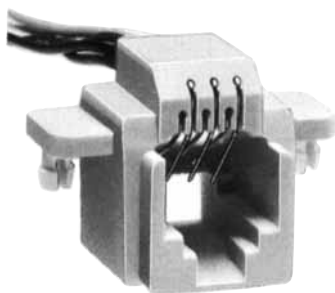

Note: Standard finish color is Vanilla white.

●TM2RGV-L66-*

●TM2RGV-L64-*

●TM2RGV-L62-*

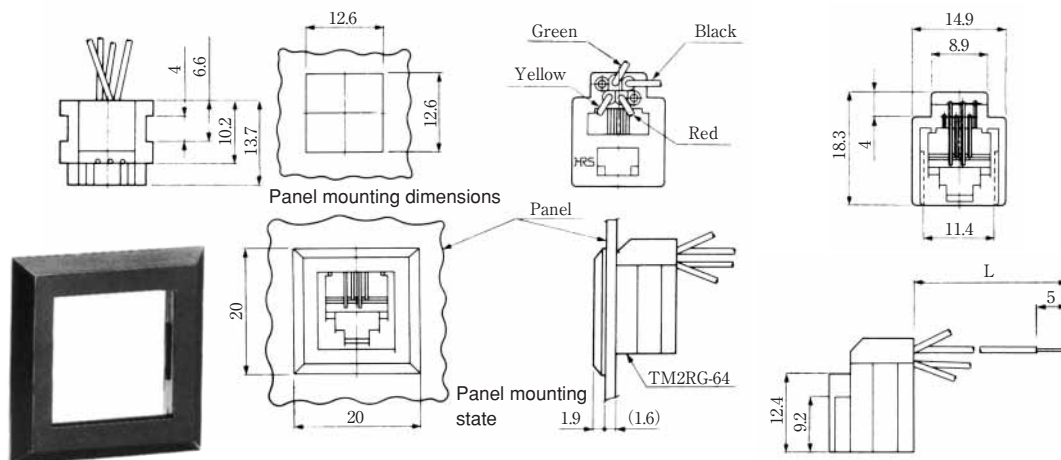

CL No.	Part No.	RoHS
222-4462-1	TM2RGV-L66-4S-150M	YES

Color	L (mm)
White	150
Yellow	150
Green	150
Red	150
Black	150
Blue	150

CL No.	Part No.	RoHS
222-4456-9	TM2RGV-L64-4S-150M	YES

Color	L (mm)
Yellow	150
Green	150
Red	150
Black	150

CL No.	Part No.	RoHS
222-4455-6	TM2RGV-L62-4S-150M	YES

Color	L (mm)
Green	150
Red	150

Note1: Standard finish color is dark brown. Note2: The drawing is shown sample of TM2RGV-L64-*

MODULAR CONNECTORS

CL 222 TM

TM1RV-647AF88- *

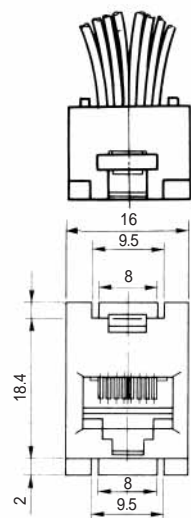

CL No.	Part No.	RoHS
222-4454-3	TM1RV647AF88-35S-150M	YES

Color	L (mm)
Brown	150
White	150
Yellow	150
Green	150
Red	150
Black	150
Blue	150
Orange	150

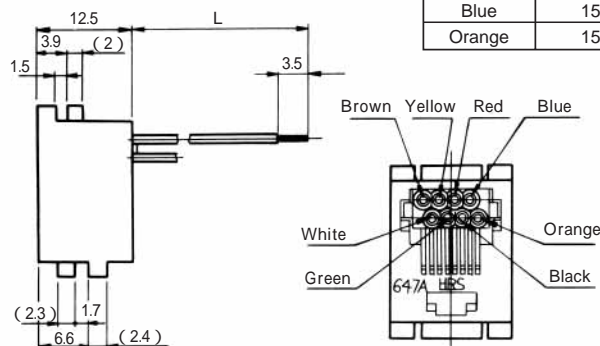

Note: Standard color is warm gray.

TM2RC-88- *

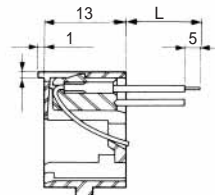
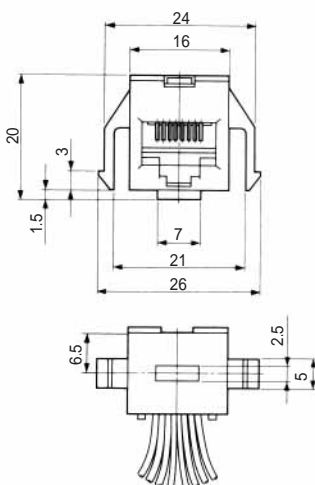
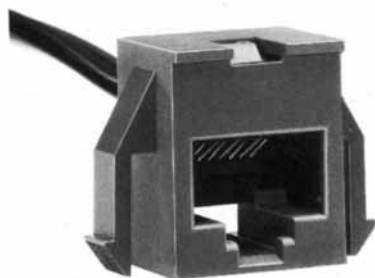

CL No.	Part No.	RoHS
222-4434-6	TM2RCV-M88-5S-450M	YES

Color	L (mm)
Gray	450
Purple	450
Blue	450
Green	450
Yellow	450
Orange	450
Red	450
Brown	450

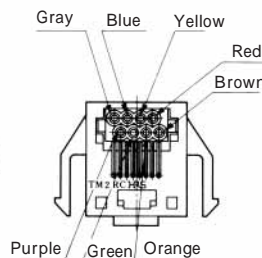

Note: Standard finish color is beige white.

Данный компонент на территории Российской Федерации

Вы можете приобрести в компании MosChip.

Для оперативного оформления запроса Вам необходимо перейти по данной ссылке:

<http://moschip.ru/get-element>

Вы можете разместить у нас заказ для любого Вашего проекта, будь то серийное производство или разработка единичного прибора.

В нашем ассортименте представлены ведущие мировые производители активных и пассивных электронных компонентов.

Нашей специализацией является поставка электронной компонентной базы двойного назначения, продукции таких производителей как XILINX, Intel (ex.ALTERA), Vicor, Microchip, Texas Instruments, Analog Devices, Mini-Circuits, Amphenol, Glenair.

Сотрудничество с глобальными дистрибьюторами электронных компонентов, предоставляет возможность заказывать и получать с международных складов практически любой перечень компонентов в оптимальные для Вас сроки.

На всех этапах разработки и производства наши партнеры могут получить квалифицированную поддержку опытных инженеров.

Система менеджмента качества компании отвечает требованиям в соответствии с ГОСТ Р ИСО 9001, ГОСТ РВ 0015-002 и ЭС РД 009

Офис по работе с юридическими лицами:

105318, г.Москва, ул.Щербаковская д.3, офис 1107, 1118, ДЦ «Щербаковский»

Телефон: +7 495 668-12-70 (многоканальный)

Факс: +7 495 668-12-70 (доб.304)

E-mail: info@moschip.ru

Skype отдела продаж:

moschip.ru

moschip.ru_4

moschip.ru_6

moschip.ru_9