

MODULAR CONNECTORS

CL 222 TM

Wire Lead Jack Type

●TM1R-616B44-*

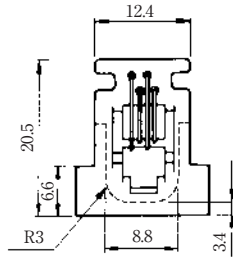
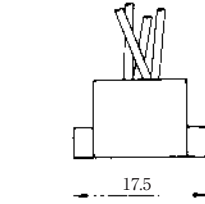
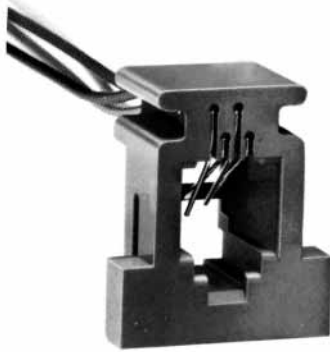

| CL No. | Part No. | RoHS |
|------------|----------------------|------|
| 222-4465-0 | TM1R-616B44-35S-150M | YES |

| Color | L (mm) |
|--------|--------|
| Yellow | 150 |
| Green | 150 |
| Red | 150 |
| Black | 150 |

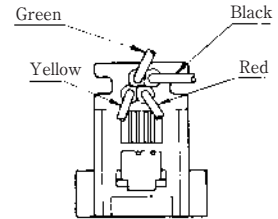
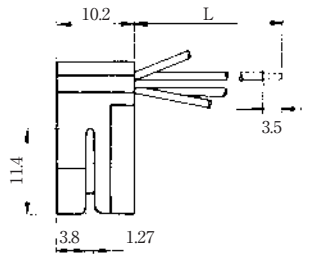

Note: Standard finish color is gray.

●TM1R-616P44-*

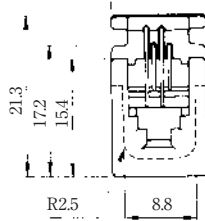
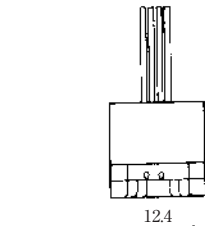
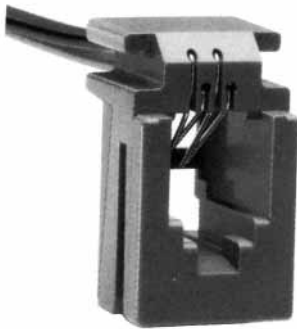

| CL No. | Part No. | RoHS |
|------------|----------------------|------|
| 222-4466-2 | TM1R-616P44-35S-150M | YES |

| Color | L (mm) |
|--------|--------|
| Yellow | 150 |
| Green | 150 |
| Red | 150 |
| Black | 150 |

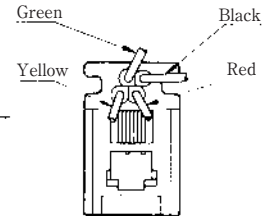
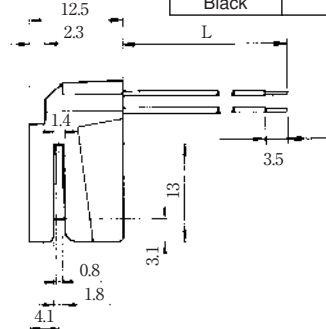

Note: Standard finish color is gray.

●TM1R-616M44-*

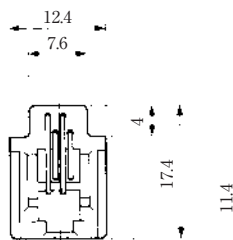
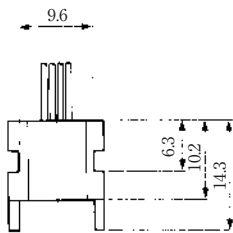

| CL No. | Part No. | RoHS |
|------------|---------------------|------|
| 222-4451-5 | TM1R-616M44-35S-70M | YES |

| Color | L (mm) |
|--------|--------|
| Yellow | 70 |
| Green | 70 |
| Red | 70 |
| Black | 70 |

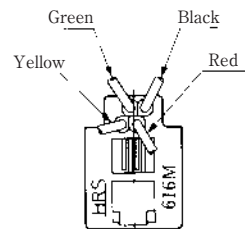
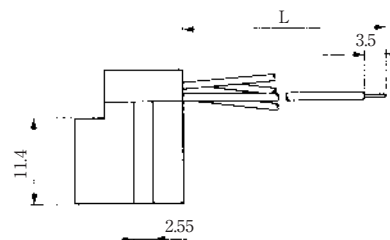

Note: Standard finish color is gray.

MODULAR CONNECTORS

CL 222 TM

TM1R-616W44-*

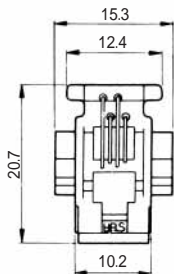
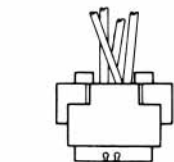
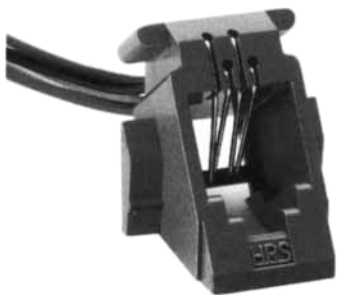

| CL No. | Part No. | RoHS |
|------------|---------------------|------|
| 222-4441-1 | TM1R-616W44-4S-150M | YES |

| Color | L (mm) |
|--------|--------|
| Yellow | 150 |
| Green | 150 |
| Red | 150 |
| Black | 150 |



Note: Standard finish color is gray.

TM2RD-F44-*

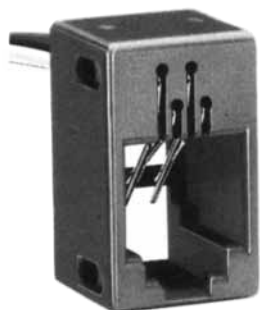

| CL No. | Part No. | RoHS |
|------------|-------------------|------|
| 222-4467-5 | TM2RD-F44-4S-150M | YES |

| Color | L (mm) |
|--------|--------|
| Yellow | 150 |
| Green | 150 |
| Red | 150 |
| Black | 150 |

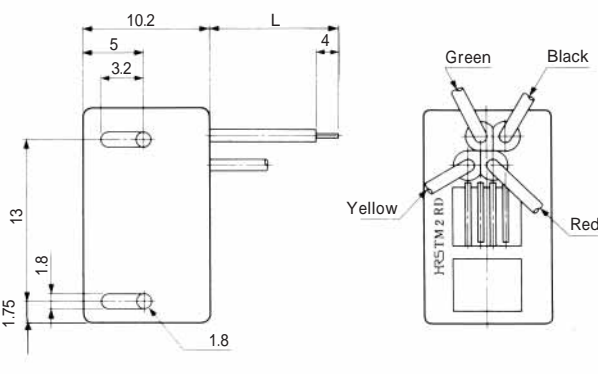

Note: Standard finish color is warm gray.

TM2RDA-F44-*

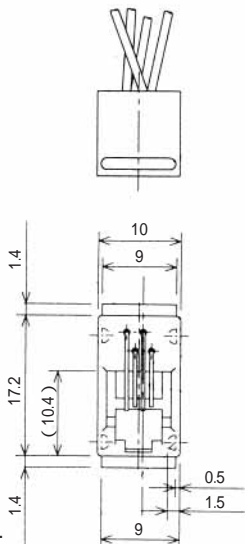
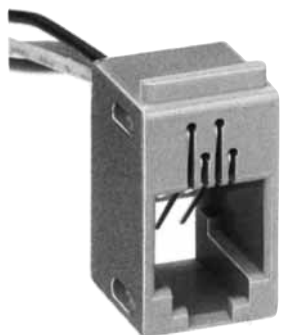

| CL No. | Part No. | RoHS |
|--------------|--------------------|------|
| CL222-4440-9 | TM2RDA-F44-4S-150M | YES |

| Color | L (mm) |
|--------|--------|
| Yellow | 150 |
| Green | 150 |
| Red | 150 |
| Black | 150 |

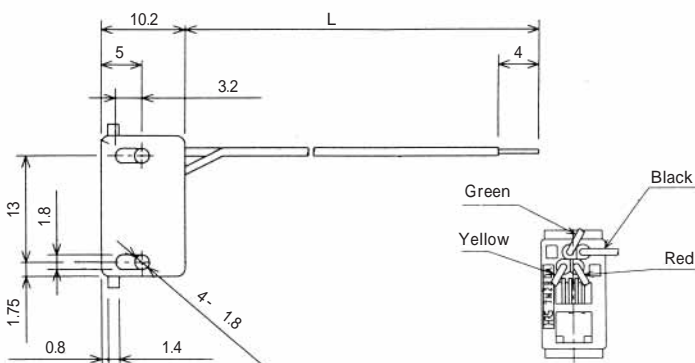

Note: Standard finish color is warm gray.

MODULAR CONNECTORS

CL 222 TM

TM6RA-144- *

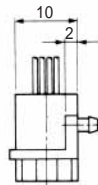
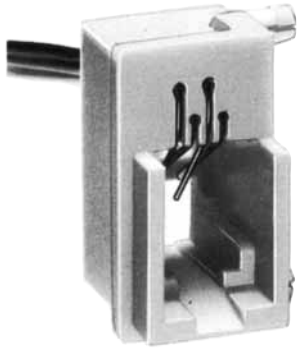

| CL No. | Part No. | RoHS |
|------------|--------------------|------|
| 222-4474-0 | TM6RA-144-35S-150M | YES |

| Color | L (mm) |
|--------|--------|
| Yellow | 150 |
| Green | 150 |
| Red | 150 |
| Black | 150 |

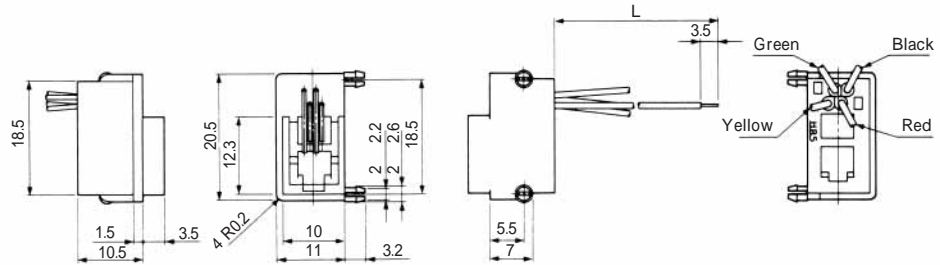

Note: Standard finish color is ash gray.

TM1RV-623K66- *
 TM1RV-623K64- *
 TM1RV-623K62- *



| CL No. | Part No. | RoHS |
|------------|----------------------|------|
| 222-4307-9 | TM1RV-623K66-4S-150M | YES |

| Color | L (mm) |
|--------|--------|
| White | 150 |
| Yellow | 150 |
| Green | 150 |
| Red | 150 |
| Black | 150 |
| Blue | 150 |

| CL No. | Part No. | RoHS |
|------------|----------------------|------|
| 222-4473-8 | TM1RV-623K64-4S-150M | YES |

| Color | L (mm) |
|--------|--------|
| Yellow | 150 |
| Green | 150 |
| Red | 150 |
| Black | 150 |

| CL No. | Part No. | RoHS |
|------------|----------------------|------|
| 222-4470-0 | TM1RV-623K62-4S-150M | YES |

| Color | L (mm) |
|-------|--------|
| Green | 150 |
| Red | 150 |

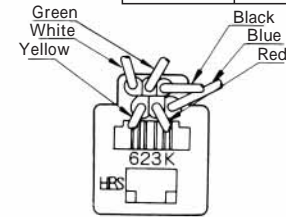
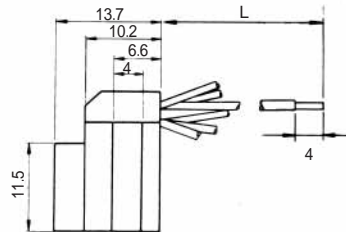
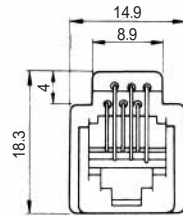

Note1: Standard finish color is gray.

Note2: The drawing is shown sample of TM1RV-623K66- *

TM1RV-623P66- *
 TM1RV-623P64- *

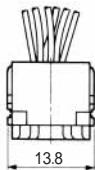
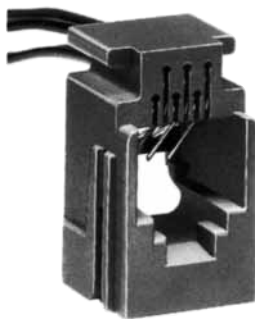

| CL No. | Part No. | RoHS |
|------------|-----------------------|------|
| 222-4471-2 | TM1RV-623P66-35S-150M | YES |

| Color | L (mm) |
|--------|--------|
| White | 150 |
| Black | 150 |
| Red | 150 |
| Green | 150 |
| Yellow | 150 |
| Blue | 150 |

| CL No. | Part No. | RoHS |
|------------|-----------------------|------|
| 222-4425-5 | TM1RV-623P64-35S-150M | YES |

| Color | L (mm) |
|--------|--------|
| Black | 150 |
| Red | 150 |
| Green | 150 |
| Yellow | 150 |

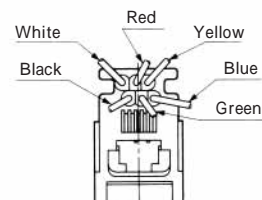
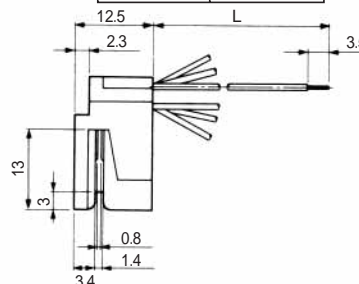
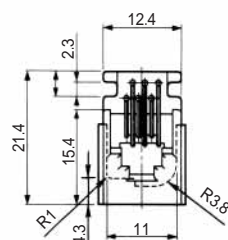

Note1: Standard finish color is gray.

Note2: The drawing is shown sample of TM1RV-623P66- *

MODULAR CONNECTORS

CL 222 TM

●TM7RV-66-*

| CL No. | Part No. | RoHS |
|------------|--------------------|------|
| 222-4472-5 | TM7RV-A66-35S-150M | YES |

| Color | L (mm) |
|--------|--------|
| White | 150 |
| Yellow | 150 |
| Green | 150 |
| Red | 150 |
| Black | 150 |
| Blue | 150 |

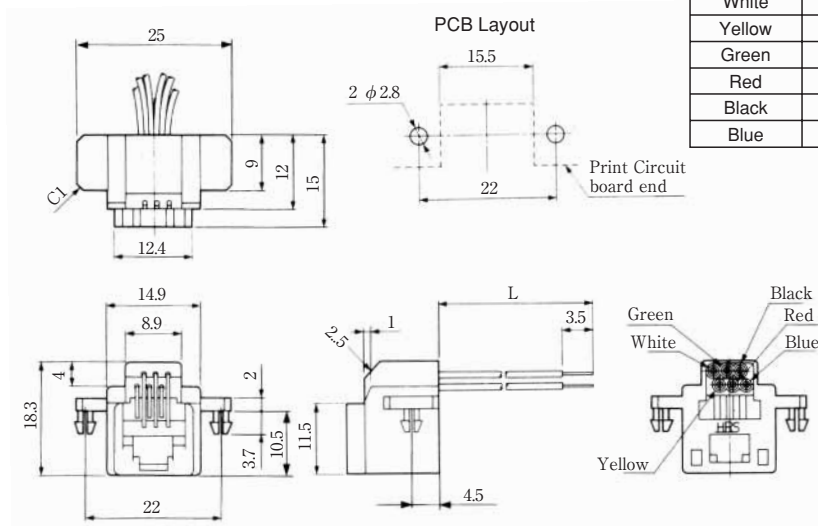
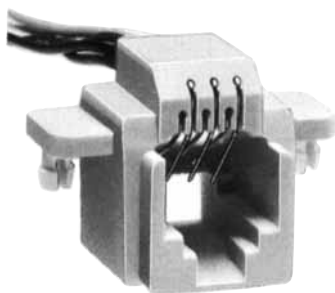

Note: Standard finish color is Vanilla white.

●TM2RGV-L66-*

●TM2RGV-L64-*

●TM2RGV-L62-*

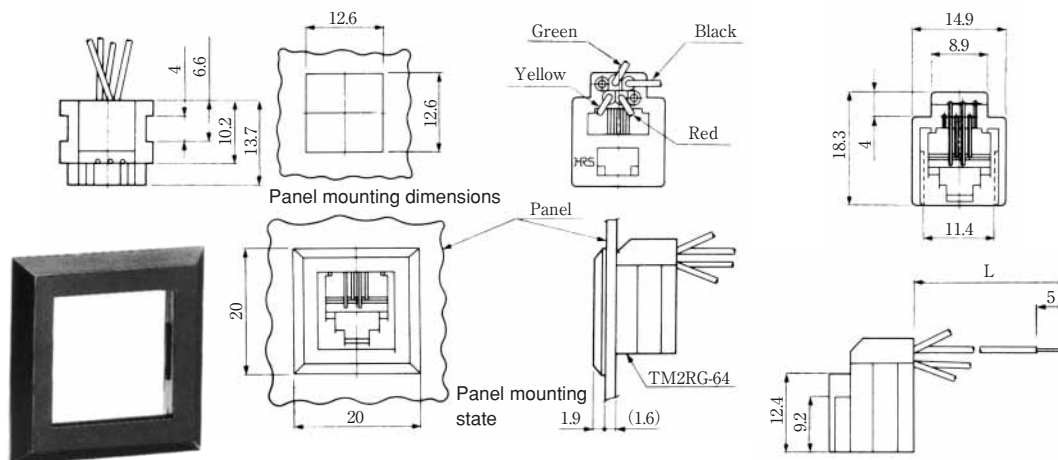

| CL No. | Part No. | RoHS |
|------------|--------------------|------|
| 222-4462-1 | TM2RGV-L66-4S-150M | YES |

| Color | L (mm) |
|--------|--------|
| White | 150 |
| Yellow | 150 |
| Green | 150 |
| Red | 150 |
| Black | 150 |
| Blue | 150 |

| CL No. | Part No. | RoHS |
|------------|--------------------|------|
| 222-4456-9 | TM2RGV-L64-4S-150M | YES |

| Color | L (mm) |
|--------|--------|
| Yellow | 150 |
| Green | 150 |
| Red | 150 |
| Black | 150 |

| CL No. | Part No. | RoHS |
|------------|--------------------|------|
| 222-4455-6 | TM2RGV-L62-4S-150M | YES |

| Color | L (mm) |
|-------|--------|
| Green | 150 |
| Red | 150 |

Note1: Standard finish color is dark brown. Note2: The drawing is shown sample of TM2RGV-L64-*

MODULAR CONNECTORS

CL 222 TM

TM1RV-647AF88- *

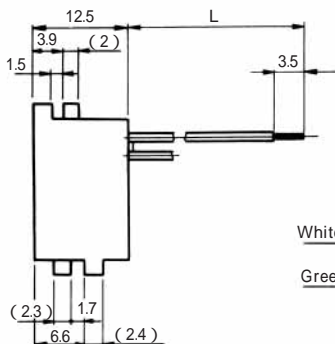
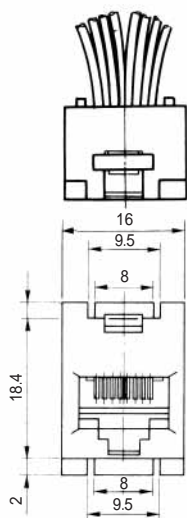

| CL No. | Part No. | RoHS |
|------------|-----------------------|------|
| 222-4454-3 | TM1RV647AF88-35S-150M | YES |

| Color | L (mm) |
|--------|--------|
| Brown | 150 |
| White | 150 |
| Yellow | 150 |
| Green | 150 |
| Red | 150 |
| Black | 150 |
| Blue | 150 |
| Orange | 150 |

Note: Standard color is warm gray.

TM2RC-88- *

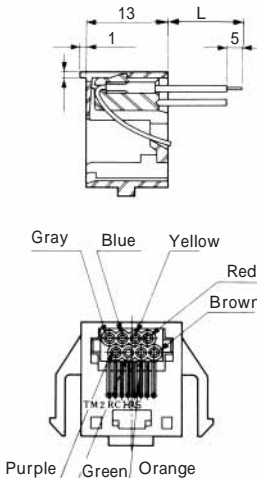
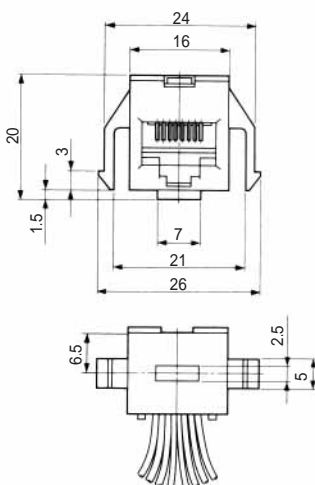
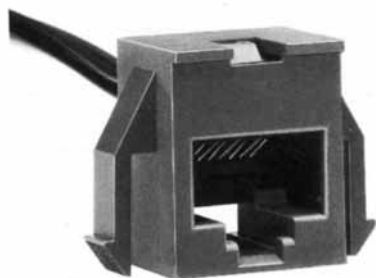

| CL No. | Part No. | RoHS |
|------------|--------------------|------|
| 222-4434-6 | TM2RCV-M88-5S-450M | YES |

| Color | L (mm) |
|--------|--------|
| Gray | 450 |
| Purple | 450 |
| Blue | 450 |
| Green | 450 |
| Yellow | 450 |
| Orange | 450 |
| Red | 450 |
| Brown | 450 |

Note: Standard finish color is beige white.

Данный компонент на территории Российской Федерации

Вы можете приобрести в компании MosChip.

Для оперативного оформления запроса Вам необходимо перейти по данной ссылке:

<http://moschip.ru/get-element>

Вы можете разместить у нас заказ для любого Вашего проекта, будь то серийное производство или разработка единичного прибора.

В нашем ассортименте представлены ведущие мировые производители активных и пассивных электронных компонентов.

Нашей специализацией является поставка электронной компонентной базы двойного назначения, продукции таких производителей как XILINX, Intel (ex.ALTERA), Vicor, Microchip, Texas Instruments, Analog Devices, Mini-Circuits, Amphenol, Glenair.

Сотрудничество с глобальными дистрибьюторами электронных компонентов, предоставляет возможность заказывать и получать с международных складов практически любой перечень компонентов в оптимальные для Вас сроки.

На всех этапах разработки и производства наши партнеры могут получить квалифицированную поддержку опытных инженеров.

Система менеджмента качества компании отвечает требованиям в соответствии с ГОСТ Р ИСО 9001, ГОСТ РВ 0015-002 и ЭС РД 009

Офис по работе с юридическими лицами:

105318, г.Москва, ул.Щербаковская д.3, офис 1107, 1118, ДЦ «Щербаковский»

Телефон: +7 495 668-12-70 (многоканальный)

Факс: +7 495 668-12-70 (доб.304)

E-mail: info@moschip.ru

Skype отдела продаж:

moschip.ru

moschip.ru_4

moschip.ru_6

moschip.ru_9