

1.0mm Pitch
SERIES

6232

1.0mmピッチ NON-ZIF RA SMT
1.0mmPitch LIF RA SMT

上接点 Top contact



下接点 Bottom contact



適用 FPC/FFC
APPLICABLE FPC/FFC

種類 KIND	公差 TOLERANCE		
	P	W	M
FPC	±0.02	+0.1 -0.05	±0.05
FFC	±0.05	±0.03	±0.1

極数 NO. OF POS.	A	B	C
3	2.0	4.1	6.6
4	3.0	5.1	7.6
5	4.0	6.1	8.6
6	5.0	7.1	9.6
7	6.0	8.1	10.6
8	7.0	9.1	11.6
9	8.0	10.1	12.6
10	9.0	11.1	13.6
11	10.0	12.1	14.6
12	11.0	13.1	15.6
13	12.0	14.1	16.6
14	13.0	15.1	17.6
15	14.0	16.1	18.6
16	15.0	17.1	19.6
17	16.0	18.1	20.6
18	17.0	19.1	21.6
19	18.0	20.1	22.6
20	19.0	21.1	23.6
21	20.0	22.1	24.6
22	21.0	23.1	25.6
23	22.0	24.1	26.6
24	23.0	25.1	27.6
25	24.0	26.1	28.6
26	25.0	27.1	29.6
27	26.0	28.1	30.6
28	27.0	29.1	31.6
29	28.0	30.1	32.6
30	29.0	31.1	33.6

注文コード ORDERING CODE

XX 6232 1XX 10X 800+

RoHS 対応品
RoHS Compliant Product

スズ銅めっき Sn-Cu Plated

接点位置 CONTACT POSITION
2: 下接点 BOTTOM CONTACT
3: 上接点 TOP CONTACT

極数 NUMBER OF POSITIONS

00: トレー梱包
TRAY PACKAGE

エンボス梱包品: 04 6232 1XX 10X 800+

Tape & Reel Package: 04 6232 1XX 10X 800+

生産対応可能極数については、営業部にご確認願います。

Feel free to contact our sales department for available numbers of positions.

1.0mm Pitch
SERIES

6232

エンボス梱包品
Tape and Reel Package

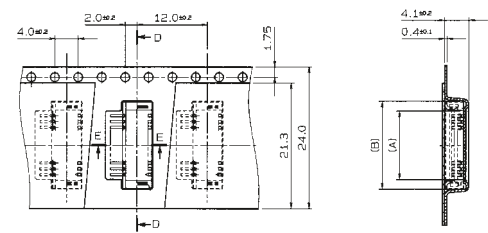

SECT. D-D

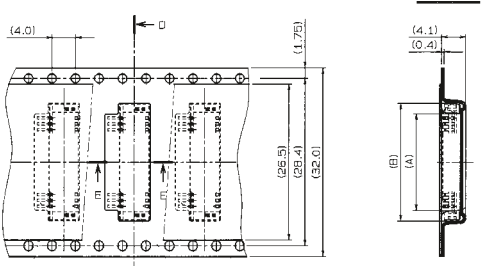

SECT. D-D

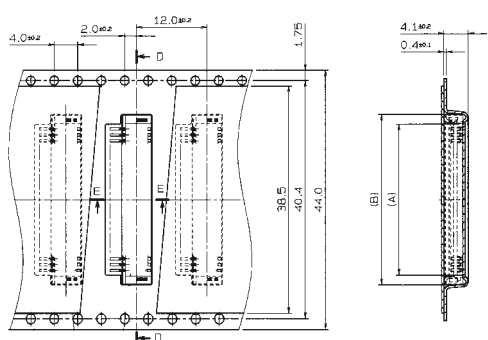

SECT. D-D

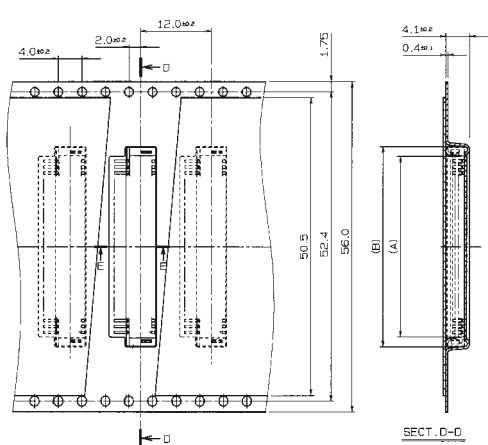

SECT. D-D

型番 PART NO.	極数 NO. OF POS	A	B
04 6232 103 10X 800+	3	3.6	6.9
↑ 104	↑ 4	4.6	7.9
105	5	5.6	8.9
106	6	6.6	9.9
107	7	7.6	10.9
108	8	8.6	11.9
↓ 109	↓ 9	9.6	12.9
04 6232 110 10X 800+	10	10.6	13.9

型番 PART NO.	極数 NO. OF POS	A	B
04 6232 111 10X 800+	11	11.6	14.9
↑ 112	↑ 12	12.6	15.9
113	13	13.6	16.9
114	14	14.6	17.9
115	15	15.6	18.9
116	16	16.6	19.9
↓ 117	↓ 17	17.6	20.9
04 6232 118 10X 800+	18	18.6	21.9

型番 PART NO.	極数 NO. OF POS	A	B
04 6232 119 10X 800+	19	19.6	22.9
↑ 120	↑ 20	20.6	23.9
121	21	21.6	24.9
122	22	22.6	25.9
123	23	23.6	26.9
↓ 124	↓ 24	24.6	27.9
04 6232 125 10X 800+	25	25.6	28.9

型番 PART NO.	極数 NO. OF POS	A	B
04 6232 126 10X 800+	26	26.6	29.9
↑ 127	↑ 27	27.6	30.9
128	28	28.6	31.9
↓ 129	↓ 29	29.6	32.9
04 6232 130 10X 800+	30	30.6	33.9

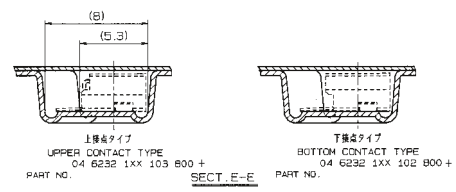

注文コード ORDERING CODE
04 6232 1XX 10X 800+

RoHS 対応品
RoHS Compliant Product

極数 NUMBER OF POSITIONS
スズ銅めっき Sn-Cu Plated
バリエーション VARIATION CODE
2: 下接点タイプ ボス無 BOTTOM CONTACT TYPE WITHOUT BOSS
3: 上接点タイプ ボス無 TOP CONTACT TYPE WITHOUT BOSS

トレー梱包品: 00 6232 1XX 10X 800+
TRAY PACKAGE: 00 6232 1XX 10X 800+

生産対応可能極数については、営業部にご確認願います。
Feel free to contact our sales department for available numbers of positions.
梱包数量 1000個/リール
PACKING QUANTITY: 1000/Reel

1.0mm Pitch
SERIES

6232

1.0mmピッチ NON-ZIF ストレート SMT 片面接点
1.0mmPitch LIF Vertical SMT Single-sided contact

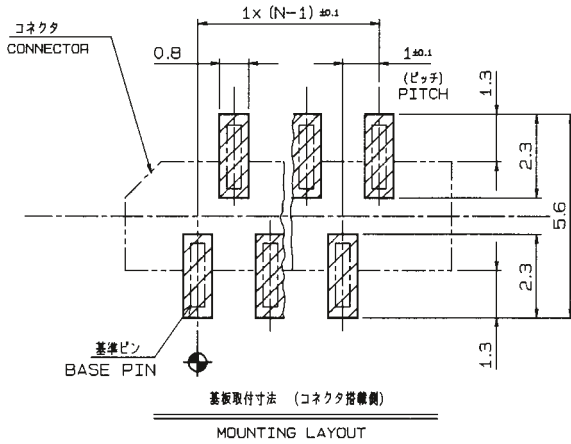

種類 KIND	公差 TOLERANCE		
	P	W	M
FPC	± 0.02	$+0.1$ -0.05	± 0.05
FFC	± 0.05	± 0.03	± 0.1

適用 FPC/FFC
APPLICABLE FPC/FFC

極数 NO. OF POS	型番 ASSEMBLY NUMBER	A	B	C
3	00 6232 103 006 800+	2.0	4.1	6.0
4	↑ 104 ↑	3.0	5.1	7.0
5	105	4.0	6.1	8.0
6	106	5.0	7.1	9.0
7	107	6.0	8.1	10.0
8	108	7.0	9.1	11.0
9	109	8.0	10.1	12.0
10	110	9.0	11.1	13.0
11	111	10.0	12.1	14.0
12	112	11.0	13.1	15.0
13	113	12.0	14.1	16.0
14	114	13.0	15.1	17.0
15	115	14.0	16.1	18.0
16	116	15.0	17.1	19.0
17	117	16.0	18.1	20.0
18	118	17.0	19.1	21.0
19	119	18.0	20.1	22.0
20	120	19.0	21.1	23.0
21	121	20.0	22.1	24.0
22	122	21.0	23.1	25.0
23	123	22.0	24.1	26.0
24	124	23.0	25.1	27.0
25	125	24.0	26.1	28.0
26	126	25.0	27.1	29.0
27	127	26.0	28.1	30.0
28	128	27.0	29.1	31.0
29	↓ 129 ↓	28.0	30.1	32.0
30	00 6232 130 006 800+	29.0	31.1	33.0

注文コード ORDERING CODE

00 6232 1XX 006 800+

RoHS 対応品

RoHS Compliant Product

極数
NUMBER OF
POSITIONS

スズ銅めっき Sn-Cu Plated

00: トレー梱包
TRAY PACKAGE

エンボス梱包品: 04 6232 1XX 015 800+
Tape & Reel Package: 04 6232 1XX 015 800+

生産対応可能極数については、営業部にご確認願います。

Feel free to contact our sales department for available numbers of positions.

1.0mm Pitch
SERIES

6232

エンボス梱包品
Tape and Reel Package



型番	極数	A	B	C
04 6232 103 015 800+	3	3.7	6.3	8.7
↑	↑	↑	↑	↑
104	4	4.7	7.3	9.7
105	5	5.7	8.3	10.7
106	6	6.7	9.3	11.7
107	7	7.7	10.3	12.7
108	8	8.7	11.3	13.7
109	9	9.7	12.3	14.7
04 6232 110 015 800+	10	10.7	13.3	15.7



型番	極数	A	B	C
04 6232 111 015 800+	11	11.7	14.3	16.7
↑	↑	↑	↑	↑
112	12	12.7	15.3	17.7
113	13	13.7	16.3	18.7
114	14	14.7	17.3	19.7
115	15	15.7	18.3	20.7
116	16	16.7	19.3	21.7
117	17	17.7	20.3	22.7
04 6232 118 015 800+	18	18.7	21.3	23.7



型番	極数	A	B	C
04 6232 119 015 800+	19	19.7	22.3	24.7
↑	↑	↑	↑	↑
120	20	20.7	23.3	25.7
121	21	21.7	24.3	26.7
122	22	22.7	25.3	27.7
123	23	23.7	26.3	28.7
124	24	24.7	27.3	29.7
04 6232 125 015 800+	25	25.7	28.3	30.7



型番	極数	A	B	C
04 6232 126 015 800+	26	26.7	29.3	31.7
↑	↑	↑	↑	↑
127	27	27.7	30.3	32.7
128	28	28.7	31.3	33.7
129	29	29.7	32.3	34.7
04 6232 130 015 800+	30	30.7	33.3	35.7



注文コード ORDERING CODE

04 6232 1XX 015 800+

04 : エンボス梱包
Tape & Reel
NUMBER OF
POSITIONS

極数

RoHS 対応品

RoHS Compliant Product

スズ銅めっき Sn-Cu Plated

トレー梱包品 : 00 6232 1XX 006 800+
Tray Package : 00 6232 1XX 006 800+

生産対応可能極数については、営業部にご確認願います。

Feel free to contact our sales department for available numbers of positions.

梱包数量 900個/リール
PACKING QUANTITY : 900/Reel

1.0mm Pitch
SERIES

6232

1.0mmピッチ NON-ZIF RA DIP 下接点

1.0mmPitch LIF RA Through hole Bottom contact

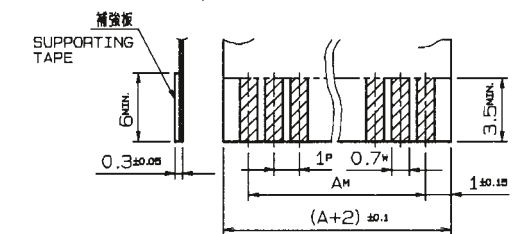
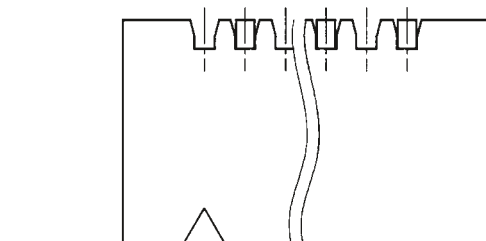

種類 KIND	公差 TOLERANCE		
	P	W	M
FPC	±0.02	+0.1 -0.05	±0.05
FFC	±0.05	±0.03	±0.1

極数 NO. OF POS	型番 ASSEMBLY NUMBER	A	B	C
3	00 6232 003 104 800+	2.0	4.1	6.0
4	↑ 004 ↑	3.0	5.1	7.0
5	005	4.0	6.1	8.0
6	006	5.0	7.1	9.0
7	007	6.0	8.1	10.0
8	008	7.0	9.1	11.0
9	009	8.0	10.1	12.0
10	010	9.0	11.1	13.0
11	011	10.0	12.1	14.0
12	012	11.0	13.1	15.0
13	013	12.0	14.1	16.0
14	014	13.0	15.1	17.0
15	015	14.0	16.1	18.0
16	016	15.0	17.1	19.0
17	017	16.0	18.1	20.0
18	018	17.0	19.1	21.0
19	019	18.0	20.1	22.0
20	020	19.0	21.1	23.0
21	021	20.0	22.1	24.0
22	022	21.0	23.1	25.0
23	023	22.0	24.1	26.0
24	024	23.0	25.1	27.0
25	025	24.0	26.1	28.0
26	026	25.0	27.1	29.0
27	027	26.0	28.1	30.0
28	028	27.0	29.1	31.0
29	029	28.0	30.1	32.0
30	00 6232 030 104 800+	29.0	31.1	33.0

適用 FPC/FFC
APPLICABLE FPC/FFC

注文コード ORDERING CODE
00 6232 0XX 104 800+

RoHS 対応品
RoHS Compliant Product

00: トレー梱包 TRAY PACKAGE スズめっき Sn Plated 極数 NUMBER OF POSITIONS

生産対応可能極数については、営業部にご確認願います。
Feel free to contact our sales department for available numbers of positions.

1.0mm Pitch
SERIES

6232

1.0mmピッチ NON-ZIF ストレート DIP 片面接点
1.0mmPitch LIF Vertical Through hole Single-sided contact



種類 KIND	公差 TOLERANCE		
	P	W	M
FPC	±0.02	+0.1 -0.05	±0.05
FFC	±0.05	±0.03	±0.1

適用 FPC/FFC
APPLICABLE FPC/FFC

極数 NO. OF POS	型番 ASSEMBLY NUMBER	A	B	C
3	00 6232 003 XXX 800+	2.0	4.1	6.0
4	↑ 004 ↑	3.0	5.1	7.0
5	005	4.0	6.1	8.0
6	006	5.0	7.1	9.0
7	007	6.0	8.1	10.0
8	008	7.0	9.1	11.0
9	009	8.0	10.1	12.0
10	010	9.0	11.1	13.0
11	011	10.0	12.1	14.0
12	012	11.0	13.1	15.0
13	013	12.0	14.1	16.0
14	014	13.0	15.1	17.0
15	015	14.0	16.1	18.0
16	016	15.0	17.1	19.0
17	017	16.0	18.1	20.0
18	018	17.0	19.1	21.0
19	019	18.0	20.1	22.0
20	020	19.0	21.1	23.0
21	021	20.0	22.1	24.0
22	022	21.0	23.1	25.0
23	023	22.0	24.1	26.0
24	024	23.0	25.1	27.0
25	025	24.0	26.1	28.0
26	026	25.0	27.1	29.0
27	027	26.0	28.1	30.0
28	028	27.0	29.1	31.0
29	↓ 029 ↓	28.0	30.1	32.0
30	00 6232 030 XXX 800+	29.0	31.1	33.0

注文コード ORDERING CODE

00 6232 0XX XXX 800+

00: トレー梱包
TRAY PACKAGE

極数
NUMBER
OF
POSITIONS

バリエーション VARIATION CODE
006: キング付 WITH KINK
007: キング無 WITHOUT KINK

RoHS 対応品
RoHS Compliant Product

スズめっき Sn Plated

生産対応可能極数については、営業部に
ご確認ください。

Feel free to contact our sales department
for available numbers of positions.

Данный компонент на территории Российской Федерации

Вы можете приобрести в компании MosChip.

Для оперативного оформления запроса Вам необходимо перейти по данной ссылке:

<http://moschip.ru/get-element>

Вы можете разместить у нас заказ для любого Вашего проекта, будь то серийное производство или разработка единичного прибора.

В нашем ассортименте представлены ведущие мировые производители активных и пассивных электронных компонентов.

Нашей специализацией является поставка электронной компонентной базы двойного назначения, продукции таких производителей как XILINX, Intel (ex.ALTERA), Vicor, Microchip, Texas Instruments, Analog Devices, Mini-Circuits, Amphenol, Glenair.

Сотрудничество с глобальными дистрибьюторами электронных компонентов, предоставляет возможность заказывать и получать с международных складов практически любой перечень компонентов в оптимальные для Вас сроки.

На всех этапах разработки и производства наши партнеры могут получить квалифицированную поддержку опытных инженеров.

Система менеджмента качества компании отвечает требованиям в соответствии с ГОСТ Р ИСО 9001, ГОСТ РВ 0015-002 и ЭС РД 009

Офис по работе с юридическими лицами:

105318, г.Москва, ул.Щербаковская д.3, офис 1107, 1118, ДЦ «Щербаковский»

Телефон: +7 495 668-12-70 (многоканальный)

Факс: +7 495 668-12-70 (доб.304)

E-mail: info@moschip.ru

Skype отдела продаж:

moschip.ru

moschip.ru_4

moschip.ru_6

moschip.ru_9