

**PLEASE CHECK WWW.MOLEX.COM FOR LATEST PART INFORMATION**

**Part Number:** **0340620006**  
**Status:** **Active**  
**Overview:** mx150  
**Description:** 5.00mm (.197") Pitch MX150™ Cable Sealed Female Connector, Single Row, 2 Circuits, Polarization B, with Connector Position Assurance, Gray

**Documents:**

[Application Specification \(PDF\)](#)      [Product Specification PS-34062-000 \(PDF\)](#)  
[Drawing \(PDF\)](#)      [RoHS Certificate of Compliance \(PDF\)](#)

**General**

Product Family	Crimp Housings
Series	<u>34062</u>
Comments	With Connector Position Assurance (CPA)
MolexKits	Yes
More Detailed Tech Information	<a href="http://ewcap.uscarteams.org">http://ewcap.uscarteams.org</a>
Overview	<u>mx150</u>
Product Name	MX150™

**Physical**

Circuits (maximum)	2
Circuits Detail	2
Color - Resin	Gray
Gender	Female
Glow-Wire Compliant	No
Keying to Mating Part	Yes
Lock to Mating Part	Yes
Material - Resin	Nylon
Number of Rows	1
Packaging Type	Bag
Panel Mount	No
Pitch - Mating Interface (in)	0.197 In
Pitch - Mating Interface (mm)	5.00 mm
Pitch - Term. Interface (in)	0.197 In
Pitch - Term. Interface (mm)	5.00 mm
Polarized to Mating Part	Yes
Stackable	No
Temperature Range - Operating	-40°C to +125°C

**Electrical**

Current - Maximum per Contact	15A
-------------------------------	-----

**Material Info**

**Reference - Drawing Numbers**

Packaging Specification	PK-30907-879
Product Specification	PS-34062-000
Sales Drawing	SD-34062-001



**EU RoHS**

**ELV and RoHS Compliant**  
**REACH SVHC**  
 Not Reviewed  
**Halogen-Free Status**  
 Not Reviewed

**China RoHS**



**Need more information on product environmental compliance?**

Email [productcompliance@molex.com](mailto:productcompliance@molex.com)  
 For a multiple part number RoHS Certificate of Compliance, [click here](#)

Please visit the [Contact Us](#) section for any non-product compliance questions.

**Search Parts in this Series**

34062Series

**Mates With**

Direct Connect only

**Use With**

34083 Tin (Sn) Cable Seal Female Terminal,  
34081 Gold (Au) Cable Seal Female Terminal

ASSEMBLY PART NUMBER	COLOR	KEYING OPTION	CPA	CLIPSLOT	TOOLED
34062-0001	BLACK	A	NO	NO	YES
34062-0002	GRAY	B	NO	NO	YES
34062-0003	BLACK	C	NO	NO	YES
34062-0004	BLACK	D	NO	NO	YES
34062-0005	BLACK	A	YES	NO	YES
34062-0006	GRAY	B	YES	NO	YES
34062-0007	BLACK	C	YES	NO	YES
34062-0008	BLACK	D	YES	NO	YES
34062-0009	GRAY	D	NO	NO	YES
34062-0010	GRAY	D	YES	NO	YES
34062-0011	BLACK	A	NO	YES	YES
34062-0012	GRAY	B	NO	YES	NO
34062-0013	BLACK	C	NO	YES	NO
34062-0014	BLACK	D	NO	YES	NO
34062-0015	BLACK	A	YES	YES	YES
34062-0016	GRAY	B	YES	YES	NO
34062-0017	BLACK	C	YES	YES	NO
34062-0018	BLACK	D	YES	YES	NO
34062-0019	GRAY	D	NO	YES	NO
34062-0020	GRAY	D	YES	YES	NO

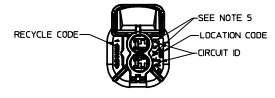
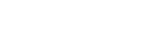
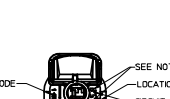
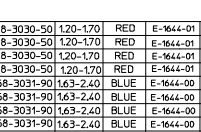
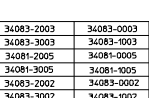
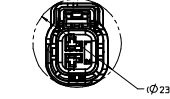
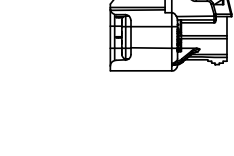
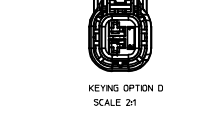
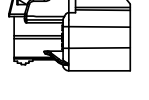
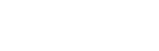
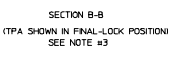
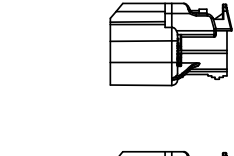
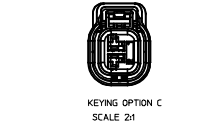
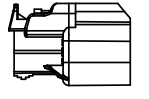
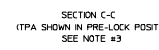
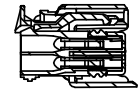
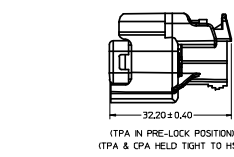
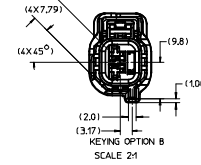
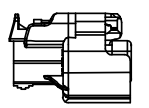
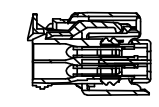
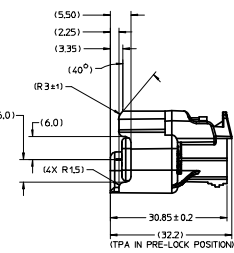
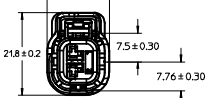
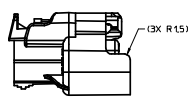
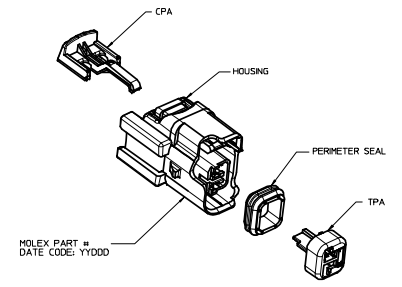
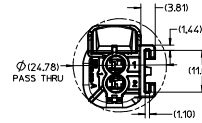
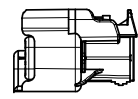
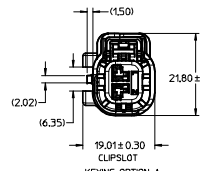
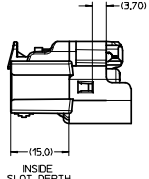
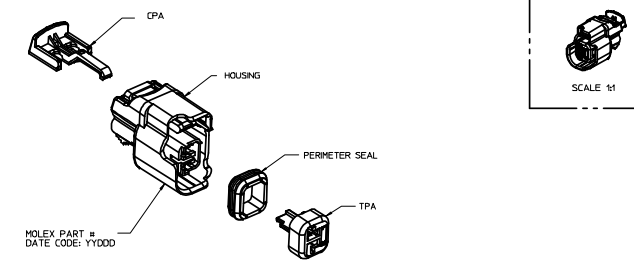
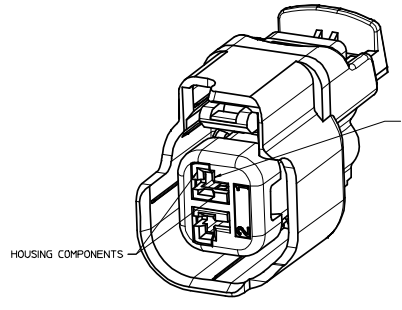
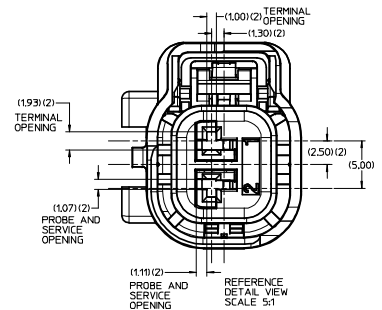

- NOTES: UNLESS OTHERWISE SPECIFIED
- ASSEMBLY CONFORMS TO:  
SAE/USCAR-12, REV 2.  
SAE/USCAR-2, REV 4.  
EXCEPT TPA REMOVAL FROM FINAL LOCK - SECOND CYCLE.  
SHALL NOT BE LESS THAN 12 NEWTONS  
SAE/USCAR-20 DEC. 2001.
  - DESIGNED TO MATE WITH DEVICE CONNECTION AS SPECIFIED IN EWCAP DRAWING 550-5-002-1-201 REV A 19-18-2003.
  - ASSEMBLY SHIPPED WITH TPA IN PRE-LOCK POSITION (SEE SECTION B-B PRE-LOCK). UPON FULL TERMINAL ASSEMBLY, EACH TPA MUST BE SNAPPED INTO ITS FINAL-LOCK POSITION.
  - OPTIONAL CPA SHOWN IN ALL VIEWS. SEE TABLES FOR SPECIFIC ASSEMBLY OPTION AND NUMBER.
  - KEYING OPTION AND ASSEMBLY MACHINE IDENTIFIER.
  - RECYCLE CODE FOR PERIMETER SEAL: SILICON 50 DUROMETER  
HOUSING: PPE/PA-GF30  
TPA/CPA: PBT-GF30
  - SYSTEM TESTED USING ESB-HL123-A, 16/18, 20/22 AWG WIRE. MS-8288 AND MS9502 ARE ACCEPTABLE ALTERNATIVES.

AWG	METRIC	PREFERRED TERMINAL	OPTIONAL TERMINAL	PAYOFF DIRECTION	PLATING	GRP	YAZAKI P/N	WIRE OD RANGE	COLOR	OSR P/N	WIRE OD RANGE	COLOR
22	0.50	34083-2003	34083-0003	RIGHT	TIN	22	7158-3030-50	1.20-1.70	RED	E-1644-01	1.19-1.65	PINK
22	0.50	34083-3003	34083-1003	LEFT	TIN	22	7158-3030-50	1.20-1.70	RED	E-1644-01	1.19-1.65	PINK
22	0.50	34081-2005	34081-0005	RIGHT	GOLD	22	7158-3030-50	1.20-1.70	RED	E-1644-01	1.19-1.65	PINK
22	0.50	34081-3005	34081-1005	LEFT	GOLD	22	7158-3030-50	1.20-1.70	RED	E-1644-01	1.19-1.65	PINK
20	0.75	34083-2002	34083-0002	RIGHT	TIN	18/20	7158-3031-90	1.63-2.40	BLUE	E-1644-00	1.60-2.10	GREEN
20	0.75	34083-3002	34083-1002	LEFT	TIN	18/20	7158-3031-90	1.63-2.40	BLUE	E-1644-00	1.60-2.10	GREEN
20	0.75	34081-2004	34081-0004	RIGHT	GOLD	18/20	7158-3031-90	1.63-2.40	BLUE	E-1644-00	1.60-2.10	GREEN
20	0.75	34081-3004	34081-1004	LEFT	GOLD	18/20	7158-3031-90	1.63-2.40	BLUE	E-1644-00	1.60-2.10	GREEN
18	1.0	34083-2002	34083-0002	RIGHT	TIN	18/20	7158-3031-90	1.63-2.40	BLUE	E-1644-00	1.60-2.10	GREEN
18	1.0	34083-3002	34083-1002	LEFT	TIN	18/20	7158-3031-90	1.63-2.40	BLUE	E-1644-00	1.60-2.10	GREEN
18	1.0	34081-2004	34081-0004	RIGHT	GOLD	18/20	7158-3031-90	1.63-2.40	BLUE	E-1644-00	1.60-2.10	GREEN
18	1.0	34081-3004	34081-1004	LEFT	GOLD	18/20	7158-3031-90	1.63-2.40	BLUE	E-1644-00	1.60-2.10	GREEN
16	1.5	34083-2001	34083-0001	RIGHT	TIN	14/16	7158-3031-90	1.63-2.40	BLUE	E-1644-02	2.10-2.50	YELLOW
16	1.5	34083-3001	34083-1001	LEFT	TIN	14/16	7158-3031-90	1.63-2.40	BLUE	E-1644-02	2.10-2.50	YELLOW
16	1.5	34081-2003	34081-0003	RIGHT	GOLD	16	7158-3031-90	1.63-2.40	BLUE	E-1644-02	2.10-2.50	YELLOW
16	1.5	34081-3003	34081-1003	LEFT	GOLD	16	7158-3031-90	1.63-2.40	BLUE	E-1644-02	2.10-2.50	YELLOW

<b>ENTER DESCRIPTION</b> EC NO. UAU2008-063Z DRAWING/REVISION/DATE/APP. 3/2003/08 APPROVED BY: 2003/04/08	<b>QUALITY SYMBOLS</b> 	<b>GENERAL TOLERANCES (UNLESS SPECIFIED)</b> mm INCH		<b>DIMENSION STYLE</b> MM ONLY		SCALE 2:1	DESIGN UNITS METRIC	THIRD ANGLE PROJECTION
		4 PLACES ± --- ± --- 3 PLACES ± --- ± --- 2 PLACES ± 0.10 ± --- 1 PLACE ± 0.3 ± ---	ANGULAR ± 3°	DRAWN BY L.P.LIM DATE 2002/11/15 CHECKED BY DKOEHLER DATE 2002/11/25 APPROVED BY SPENDLET DATE 2002/11/25	TITLE <b>CONNECTOR ASSEMBLY</b> <b>2-WAY FUEL 15MM FEMALE</b> <b>FUEL INJECTOR CONNECTOR</b>			
DRAFT WHERE APPLICABLE MUST REMAIN WITHIN DIMENSIONS		MATERIAL NO. SEE TABLE DOCUMENT NO. SD-34062-001		SHEET NO. 4 OF 1		MOLEX INCORPORATED		

## Данный компонент на территории Российской Федерации

### Вы можете приобрести в компании MosChip.

Для оперативного оформления запроса Вам необходимо перейти по данной ссылке:

<http://moschip.ru/get-element>

Вы можете разместить у нас заказ для любого Вашего проекта, будь то серийное производство или разработка единичного прибора.

В нашем ассортименте представлены ведущие мировые производители активных и пассивных электронных компонентов.

Нашей специализацией является поставка электронной компонентной базы двойного назначения, продукции таких производителей как XILINX, Intel (ex.ALTERA), Vicor, Microchip, Texas Instruments, Analog Devices, Mini-Circuits, Amphenol, Glenair.

Сотрудничество с глобальными дистрибьюторами электронных компонентов, предоставляет возможность заказывать и получать с международных складов практически любой перечень компонентов в оптимальные для Вас сроки.

На всех этапах разработки и производства наши партнеры могут получить квалифицированную поддержку опытных инженеров.

Система менеджмента качества компании отвечает требованиям в соответствии с ГОСТ Р ИСО 9001, ГОСТ РВ 0015-002 и ЭС РД 009

### Офис по работе с юридическими лицами:

105318, г.Москва, ул.Щербаковская д.3, офис 1107, 1118, ДЦ «Щербаковский»

Телефон: +7 495 668-12-70 (многоканальный)

Факс: +7 495 668-12-70 (доб.304)

E-mail: [info@moschip.ru](mailto:info@moschip.ru)

Skype отдела продаж:

moschip.ru

moschip.ru\_4

moschip.ru\_6

moschip.ru\_9