

DATA SHEET

SKY67159-396LF: 200 to 3800 MHz Broadband Low-Noise Amplifier

Applications

- FDD and TDD 2G/3G/4G LTE systems
- Receive LNA for micro-cell, macro-cell, and small-cell base stations
- Active antenna array and massive MIMO
- Land mobile radios and military communications
- Low-noise broadband gain block and driver amplifier

Features

- Excellent broadband flat gain performance
- Low noise figure
- High IP3 performance over voltage
- Single matching circuit for 200 to 3800 MHz
- Adjustable supply current from 30 to 100 mA
- Flexible bias voltage: 3 to 5 V
- Fast rise/fall time ENABLE function suitable for TDD application
- Temperature and process-stable active bias up to +105 °C
- Miniature DFN (8-pin, 2 x 2 mm) package (MSL1 @ 260 °C per JEDEC J-STD-020)



Skyworks Green™ products are compliant with all applicable legislation and are halogen-free. For additional information, refer to *Skyworks Definition of Green™*, document number SQ04-0074.

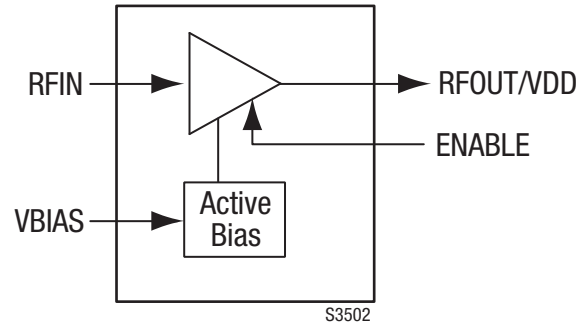

Figure 1. SKY67159-396LF Block Diagram

Description

The SKY67159-396LF is an ultra-broadband low-noise amplifier with superior gain flatness and exceptional linearity.

The compact 2 x 2 mm, 8-pin Dual Flat No Lead packaged LNA is designed for FDD and TDD 2G/3G/4G LTE small-cell base stations operating from 200 to 3800 MHz.

The internal active bias circuitry provides stable performance over temperature and process variation. The device offers the ability to externally adjust supply current.

A functional block diagram is shown in Figure 1. The pin configuration and package are shown in Figure 2. Signal pin assignments and functional pin descriptions are provided in Table 1.

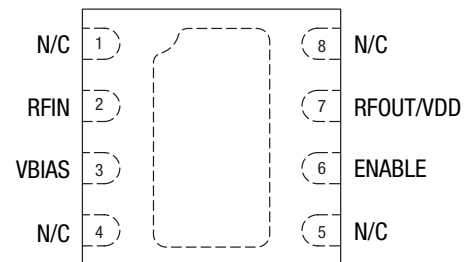

Figure 2. SKY67159-396LF Pinout (Top View)

Table 1. SKY67159-396LF Signal Descriptions

Pin	Name	Description	Pin	Name	Description
1	N/C	No connection. May be left open, connected to VDD, or connected to ground with no change in performance.	5	N/C	No connection. May be connected to ground with no change in performance.
2	RFIN	RF input. DC blocking capacitor required.	6	ENABLE	Enable pin. Active low = amplifier ON state
3	VBIAS	Bias voltage for input gate. External resistor sets current consumption.	7	RFOUT/VDD	RF output. Apply VDD through RF choke inductor. DC blocking capacitor required.
4	N/C	No connection. May be connected to ground with no change in performance.	8	N/C	No connection. May be connected to ground with no change in performance.

Electrical and Mechanical Specifications

The absolute maximum ratings of the SKY67159-396LF are provided in Table 2. Electrical specifications are provided in Tables 3 through 5.

Typical performance characteristics are illustrated in Figures 3 through 27.

Table 2. SKY67159-396LF Absolute Maximum Ratings¹

Parameter	Symbol	Minimum	Maximum	Units
Supply voltage	VDD		5.5	V
Quiescent supply current	I _{CC}		100	mA
RF input power (C/W)	P _{IN}		+21	dBm
Storage temperature	T _{STG}	-40	+150	°C
Operating temperature	T _A	-40	+105	°C
Junction temperature	T _J		+150	°C
Electrostatic discharge:	ESD			
Charged Device Model (CDM), Class 4			1000	V
Human Body Model (HBM), Class 1A			250	V
Machine Model (MM), Class A			30	V

¹ Exposure to maximum rating conditions for extended periods may reduce device reliability. There is no damage to device with only one parameter set at the limit and all other parameters set at or below their nominal value. Exceeding any of the limits listed here may result in permanent damage to the device.

ESD HANDLING: *Although this device is designed to be as robust as possible, electrostatic discharge (ESD) can damage this device. This device must be protected at all times from ESD when handling or transporting. Static charges may easily produce potentials of several kilovolts on the human body or equipment, which can discharge without detection. Industry-standard ESD handling precautions should be used at all times.*

Table 3. SKY67159-396LF Electrical Specifications: Thermal Data¹
(VDD = 3.3 V, Enable = GND, TA = +25 °C, PIN = -20 dBm, Characteristic Impedance [Zo] = 50 Ω, Unless Otherwise Noted)

Parameter	Symbol	Test Condition	Min	Typical	Max	Units
Thermal resistance	θ_{JC}			40		°C/W
Channel temperature @ +85 °C reference (package heat slug)		VDD = 3.3 V, Ico = 45 mA, no RF applied, dissipated power = 0.15 W		90.9		°C

¹ Performance is guaranteed only under the conditions listed in this table.

Table 4. SKY67159-396LF Electrical Specifications: 700 to 2700 MHz Optimized Tuning¹ (1 of 2)
(VDD = 3.3 V, Enable = GND, TA = +25 °C, PIN = -20 dBm, Characteristic Impedance [Zo] = 50 Ω, Unless Otherwise Noted)

Parameter	Symbol	Test Condition	Min	Typical	Max	Units
RF Specifications						
Noise figure ²	NF	@ 700 MHz @ 1200 MHz @ 2100 MHz @ 2700 MHz		0.95 0.97 0.98 1		dB dB dB dB
Small signal gain	IS21l	@ 700 MHz @ 1200 MHz @ 2100 MHz @ 2700 MHz		17.8 17.5 17.3 17.1		dB dB dB dB
Input return loss	IS11l	@ 700 MHz @ 1200 MHz @ 2100 MHz @ 2700 MHz		18 20 20 18		dB dB dB dB
Output return loss	IS22l	@ 700 MHz @ 1200 MHz @ 2100 MHz @ 2700 MHz		22 19 19 22		dB dB dB dB
Reverse isolation	IS12l	@ 700 MHz @ 1200 MHz @ 2100 MHz @ 2700 MHz		22 22 22 23		dB dB dB dB
Third order input intercept point	IIP3	@ 700 MHz, $\Delta f = 1$ MHz, PIN = -20 dBm/tone @ 2700 MHz, $\Delta f = 1$ MHz, PIN = -20 dBm/tone	12 10	14.2 12.4		dBm dBm
Third order output intercept point	OIP3	@ 700 MHz, $\Delta f = 1$ MHz, PIN = -20 dBm/tone @ 2700 MHz, $\Delta f = 1$ MHz, PIN = -20 dBm/tone	30 27.5	32 29.5		dBm dBm
1 dB input compression point	IP1dB	@ 700 MHz @ 2700 MHz	-1 -2	+1 0		dBm dBm
1 dB output compression point	OP1dB	@ 700 MHz @ 2700 MHz	+16 +14	+18 +16		dBm dBm

Table 4. SKY67159-396LF Electrical Specifications: 700 to 2700 MHz Optimized Tuning¹ (2 of 2)
(VDD = 3.3 V, Enable = GND, TA = +25 °C, PIN = -20 dBm, Characteristic Impedance [Zo] = 50 Ω, Unless Otherwise Noted)

Parameter	Symbol	Test Condition	Min	Typical	Max	Units
DC Specifications						
Supply voltage	VDD			3.3		V
Quiescent current	IDD	Set with external resistor (RBIAS = 4.7 kΩ)		45		mA
Bias current	IBIAS					μA
Enable voltage: Gain mode	VEN		0		0.2	V
Power-down mode			1.5		5.5	V
Enable rise time ³	ton	@ 2700 MHz		400		ns
Enable fall time ³	toff	@ 2700 MHz		150		ns

¹ Performance is guaranteed only under the conditions listed in this table.

² Connector and board loss are de-embedded.

³ Tested with a 100 kHz square wave, 1000 pF capacitance-to-ground on the ENABLE pin. Switching time can be improved by reducing the value of, or eliminating, the 1000 pF capacitor on pin 6 (component M17 in Figure 19).

Table 5. SKY67159-396LF Electrical Specifications: 3400 to 3800 MHz Optimized Tuning (1 of 2)
(VDD = +3.3 V, ENABLE = LOW, ICQ = 45 mA, TOP = +25 °C, PIN = -20 dBm, Optimized for 3400 to 3800 MHz Operation, Unless Otherwise Noted)

Parameter	Symbol	Test Condition	Min	Typical	Max	Units
RF Specifications						
Noise figure	NF	@ 3400 MHz		1.2		dB
		@ 3600 MHz		1.25		dB
		@ 3800 MHz		1.3		dB
Small signal gain	IS21I	@ 3400 MHz		16.8		dB
		@ 3600 MHz		16.7		dB
		@ 3800 MHz		16.5		dB
Input return loss	IS11I	@ 3400 MHz		24		dB
		@ 3600 MHz		30		dB
		@ 3800 MHz		30		dB
Output return loss	IS22I	@ 3400 MHz		22		dB
		@ 3600 MHz		21		dB
		@ 3800 MHz		22		dB
Reverse isolation	IS12I	@ 3400 MHz		23		dB
		@ 3600 MHz		23		dB
		@ 3800 MHz		23		dB

Table 5. SKY67159-396LF Electrical Specifications: 3400 to 3800 MHz Optimized Tuning (2 of 2)
(VDD = +3.3 V, ENABLE = LOW, Icq = 45 mA, Top = +25 °C, PIN = -20 dBm, Optimized for 3400 to 3800 MHz Operation, Unless Otherwise Noted)

Parameter	Symbol	Test Condition	Min	Typical	Max	Units
<i>RF Specifications</i>						
Third order input intercept point	IIP3	@ 3400 MHz, $\Delta f = 1$ MHz, PIN = -20 dBm/tone	9	11.4		dBm
		@ 3800 MHz, $\Delta f = 1$ MHz, PIN = -20 dBm/tone	8	10.9		dBm
Third order output intercept point	OIP3	@ 3400 MHz, $\Delta f = 1$ MHz, PIN = -20 dBm/tone	25	28.2		dBm
		@ 3800 MHz, $\Delta f = 1$ MHz, PIN = -20 dBm/tone	24	27.4		dBm
1 dB input compression point	IP1dB	@ 3400 MHz	-3	-1		dBm
		@ 3800 MHz	-3	-1		dBm
1 dB output compression point	OP1dB	@ 3400 MHz	12	14.8		dBm
		@ 3800 MHz	12	14.5		dBm

Typical Performance Characteristics, 700 to 2700 MHz

(VDD = 3.3 V, Enable = GND, ICQ = 45 mA, TA = +25 °C, PIN = -20 dBm, Characteristic Impedance [Zo] = 50 Ω, Unless Otherwise Noted)

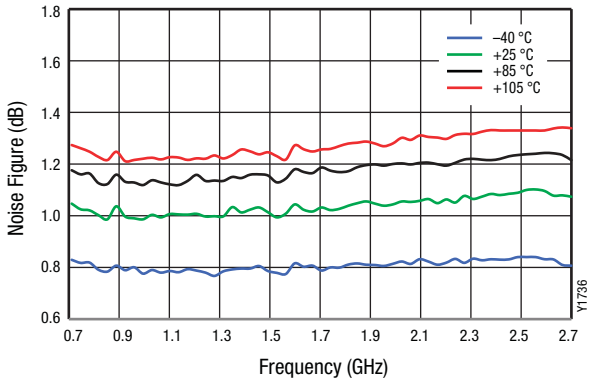

Figure 3. Evaluation board NF vs Frequency over Temperature

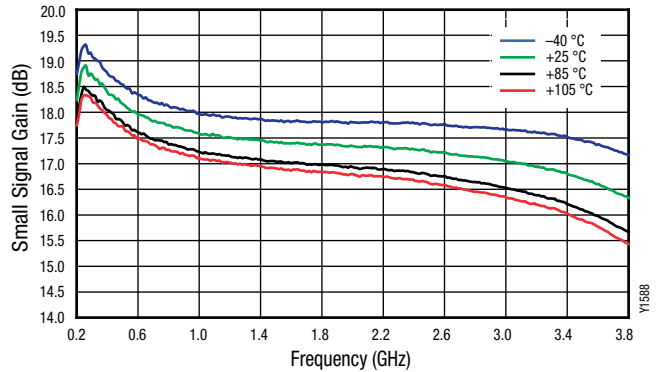

Figure 4. Narrow Band Gain vs Frequency over Temperature

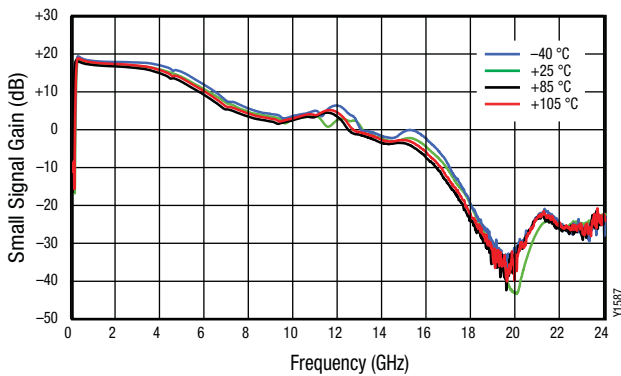

Figure 5. Broadband Gain vs Frequency over Temperature

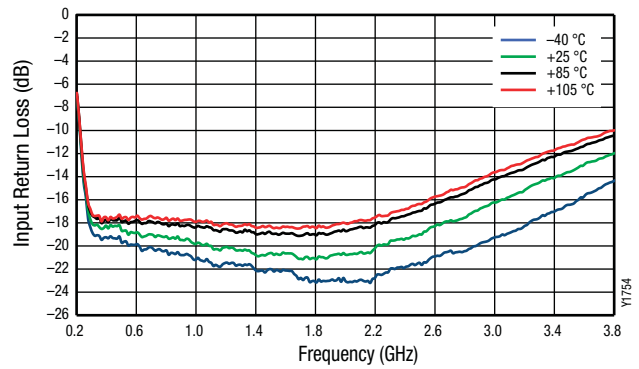

Figure 6. Narrowband Input Return Loss vs Frequency over Temperature

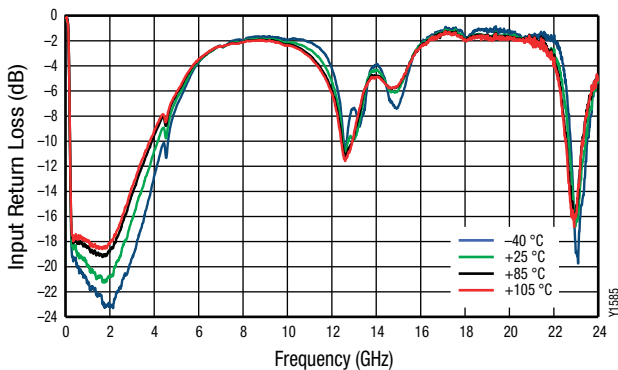

Figure 7. Broadband Input Return Loss vs Frequency over Temperature

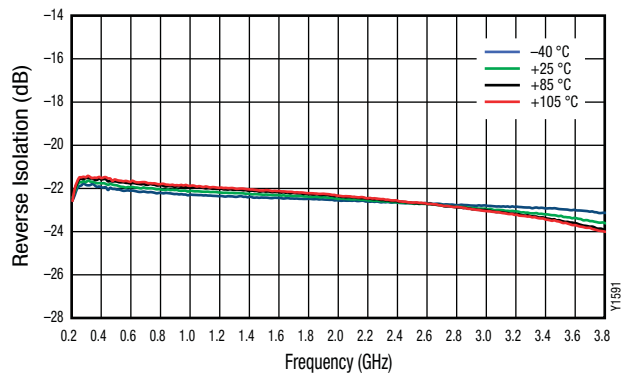

Figure 8. Narrowband Reverse Isolation vs Frequency over Temperature

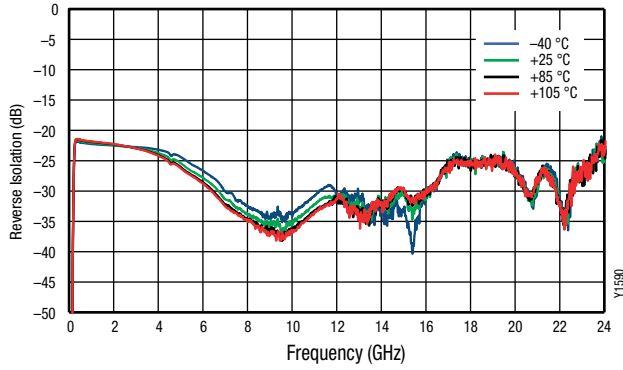

Figure 9. Broadband Reverse Isolation vs Frequency over Temperature

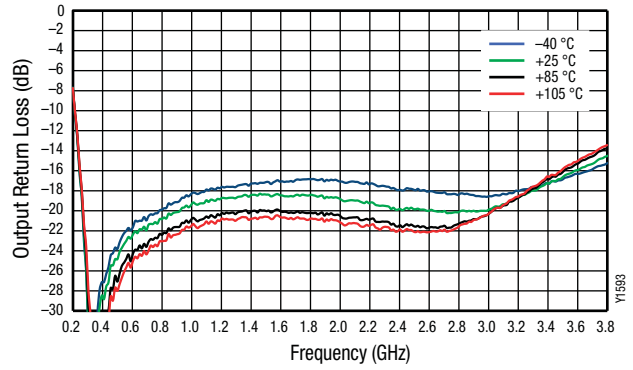

Figure 10. Narrowband Output Return Loss vs Frequency over Temperature

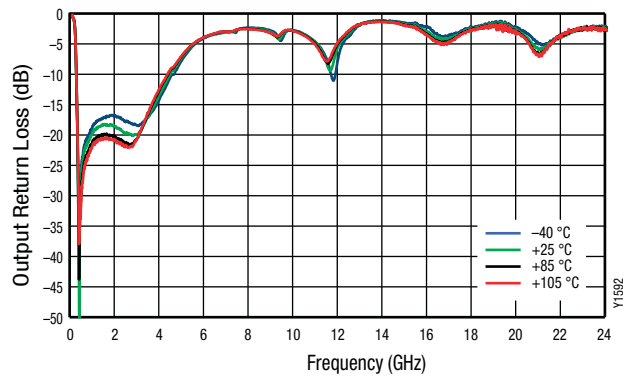

Figure 11. Broadband Output Return Loss vs Frequency over Temperature

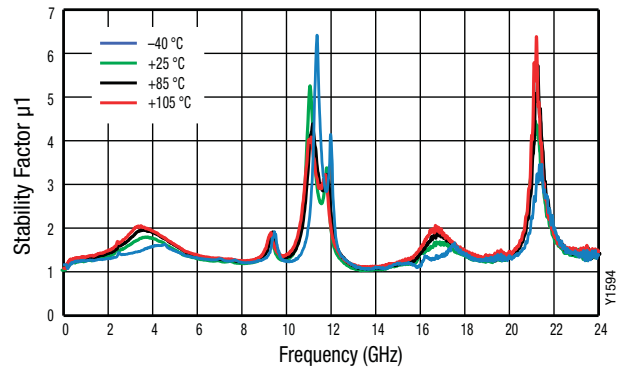

Figure 12. Stability Factor (μ_1) vs Frequency over Temperature

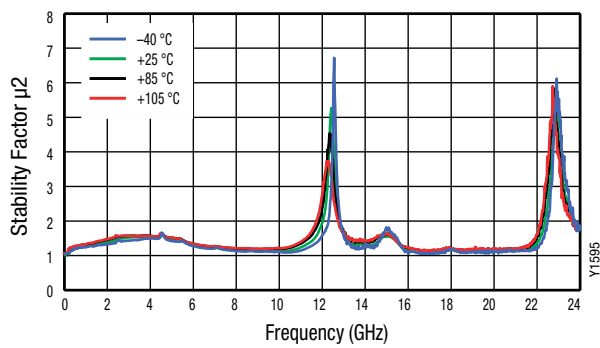

Figure 13. Stability Factor (μ_2) vs Frequency over Temperature

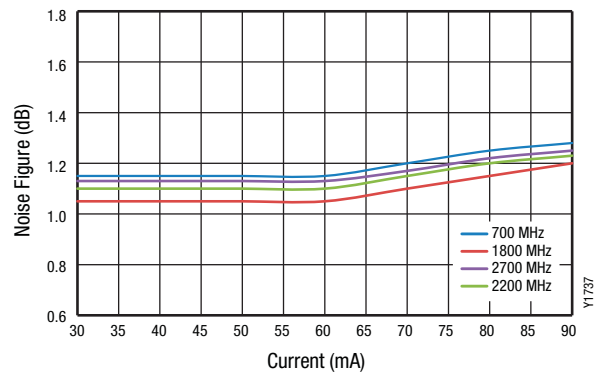

Figure 14. Evaluation Board Noise Figure vs Quiescent Current over Frequency

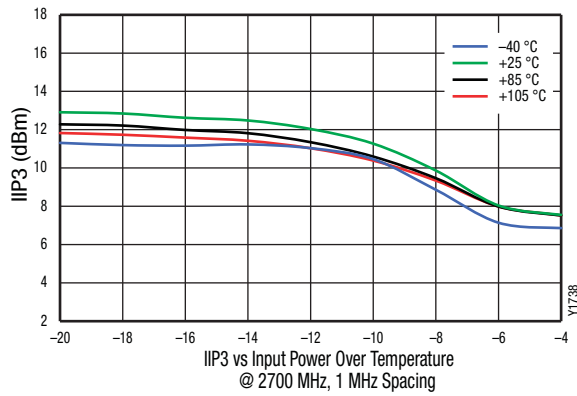

Figure 15. OIP3 vs Input Power over Temperature (@ 2700 MHz, 1 MHz Spacing)

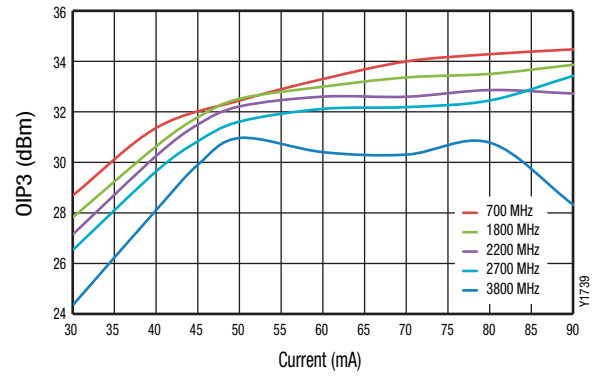

Figure 16. OIP3 vs Quiescent Current over Frequency

Typical Performance Characteristics, 3400 to 3800 MHz Optimized Tuning

(V_{DD} = 3.3 V, Enable = GND, I_{CQ} = 45 mA, T_A = +25 °C, P_{IN} = -20 dBm, Characteristic Impedance [Z₀] = 50 Ω, Unless Otherwise Noted)

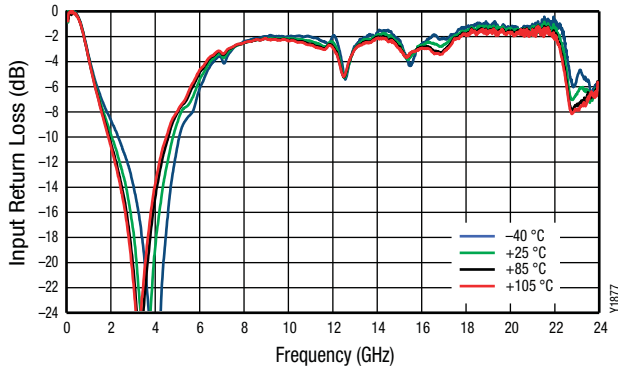

Figure 17. Broadband Input Return Loss vs Frequency over Temperature

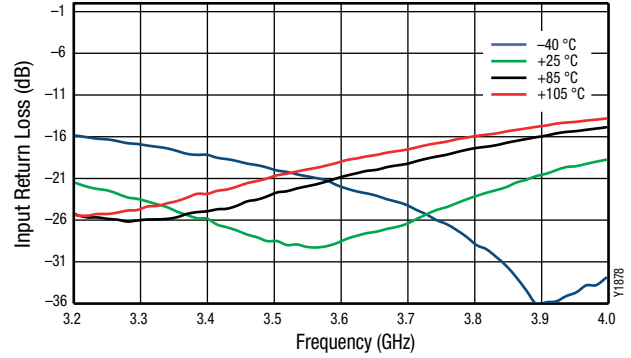

Figure 18. Narrowband Input Return Loss vs Frequency over Temperature

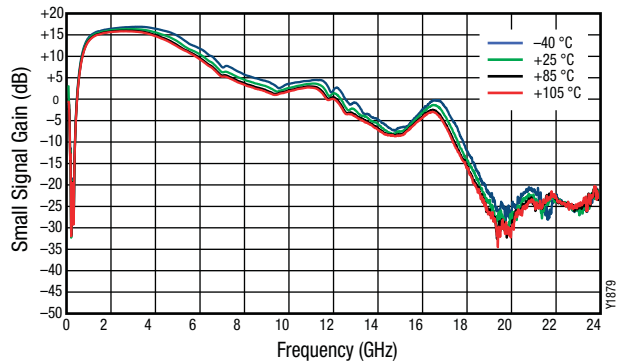

Figure 19. Broadband Gain vs Frequency over Temperature

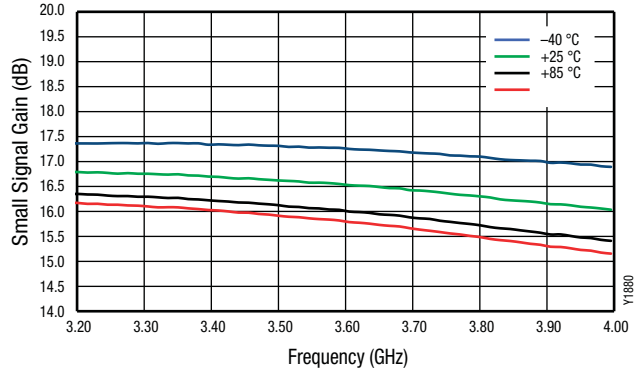

Figure 20. Narrow Band Gain vs Frequency over Temperature

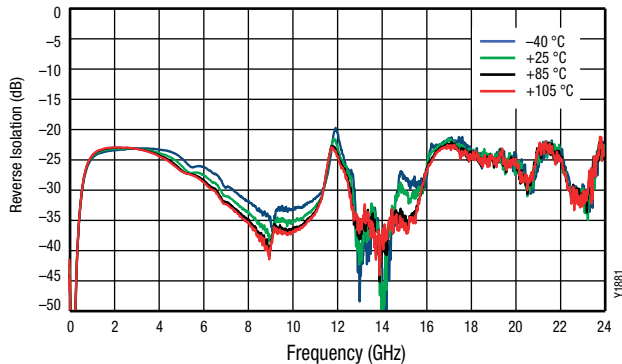

Figure 21. Broadband Reverse Isolation vs Frequency over Temperature

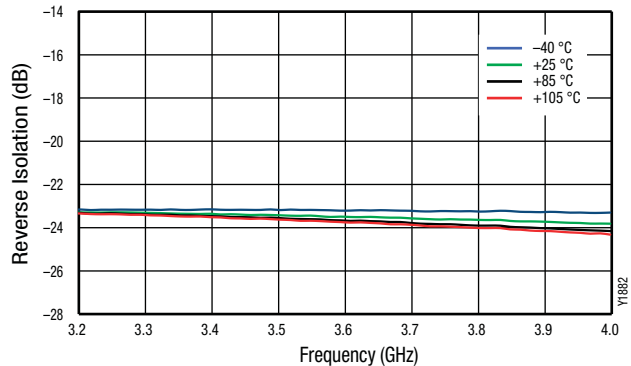

Figure 22. Narrowband Reverse Isolation vs Frequency over Temperature

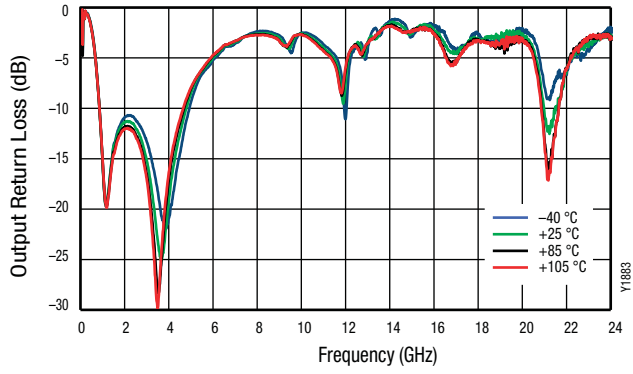

Figure 23. Broadband Output Return Loss vs Frequency over Temperature

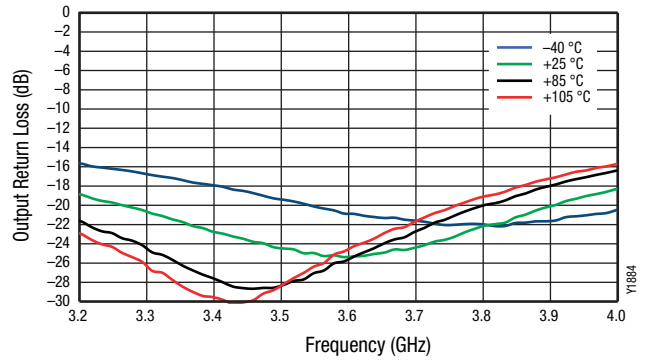

Figure 24. Narrowband Output Return Loss vs Frequency over Temperature

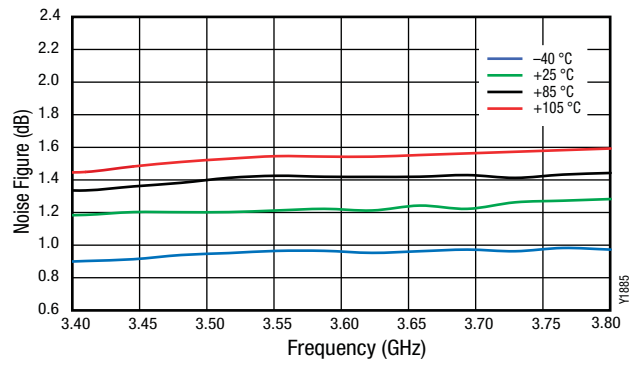

Figure 25. Noise Figure vs Frequency

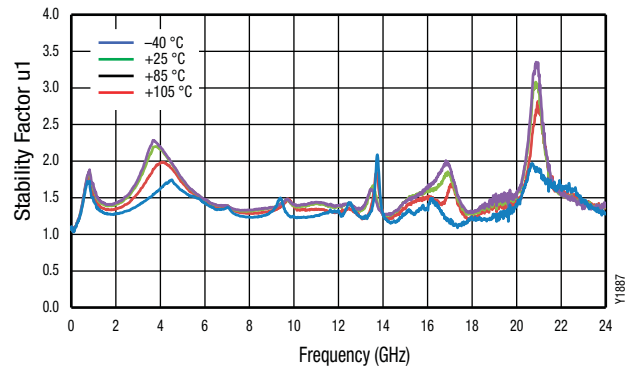

Figure 26. Stability Factor u1 vs Frequency

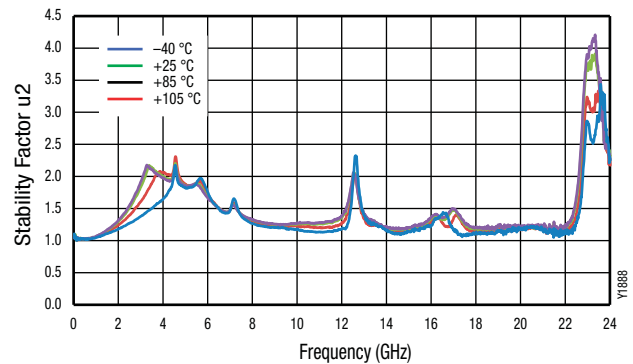

Figure 27. Stability Factor u2 vs Frequency

Evaluation Board Description

The SKY67159-396LF Evaluation Board is used to test the performance of the SKY67159-396LF LNA.

An assembly drawing for the Evaluation Board is shown in Figure 28. The layer detail is provided in Figure 29. An Evaluation Board schematic (optimized for 700 to 2700 MHz) diagram is provided in Figure 30. Table 6 provides the Bill of Materials (BOM) list for the optimized frequency band (700 to 2700 MHz). An Evaluation Board schematic (optimized for 3400 to 3800 MHz) diagram is provided in Figure 31. Table 7 provides the Bill of Materials (BOM) list for the optimized frequency band (3400 to 3800 MHz).

Package Dimensions

The PCB layout footprint for the SKY67159-396LF is provided in Figure 32. Typical part markings are shown in Figure 33. Package dimensions are shown in Figure 34, and tape and reel dimensions are provided in Figure 35.

Package and Handling Information

Instructions on the shipping container label regarding exposure to moisture after the container seal is broken must be followed. Otherwise, problems related to moisture absorption may occur when the part is subjected to high temperature during solder assembly.

The SKY67159-396LF is rated to Moisture Sensitivity Level 1 (MSL1) at 260 °C. It can be used for lead or lead-free soldering. For additional information, refer to the Skyworks Application Note, *Solder Reflow Information*, document number 200164.

Care must be taken when attaching this product, whether it is done manually or in a production solder reflow environment. Production quantities of this product are shipped in a standard tape and reel format.

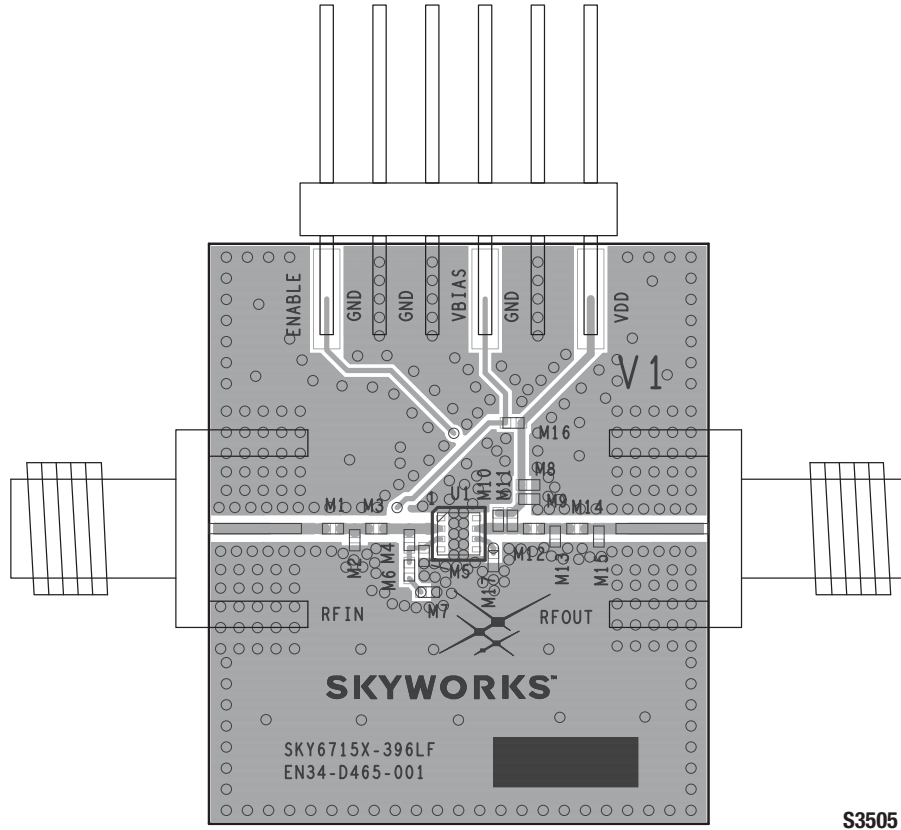

Figure 28. SKY67159-396LF Evaluation Board Assembly Diagram

Cross Section	Name	Thickness (mm)	Material
	MSK-NS		
	TRA-NS	0.03556	Cu foil
	Laminate	0.254 ± 0.152	Rogers 4350B
	TRA-2	0.0178	Cu foil
	Laminate	0.889 nom.	FR4 Prepreg (Note 1)
	TRA-3	0.0178	Cu foil
	Laminate	0.254 ± 0.152	FR4 Core
	TRA-FS	0.0178	Cu foil
	MSK-PS		

Note 1: Adjust this thickness to meet total thickness goal.

General Notes:

Material: Rogers R04350, $\epsilon_r = 3.66$
 Layer 1 thickness: 0.254 mm
 Overall board thickness: 1.575 mm
 50 Ω transmission line width: 0.522 mm
 Coplanar ground spacing: 0.394 mm
 Via diameter: 0.254 mm

S2530

Figure 29. Layer Detail Physical Characteristics

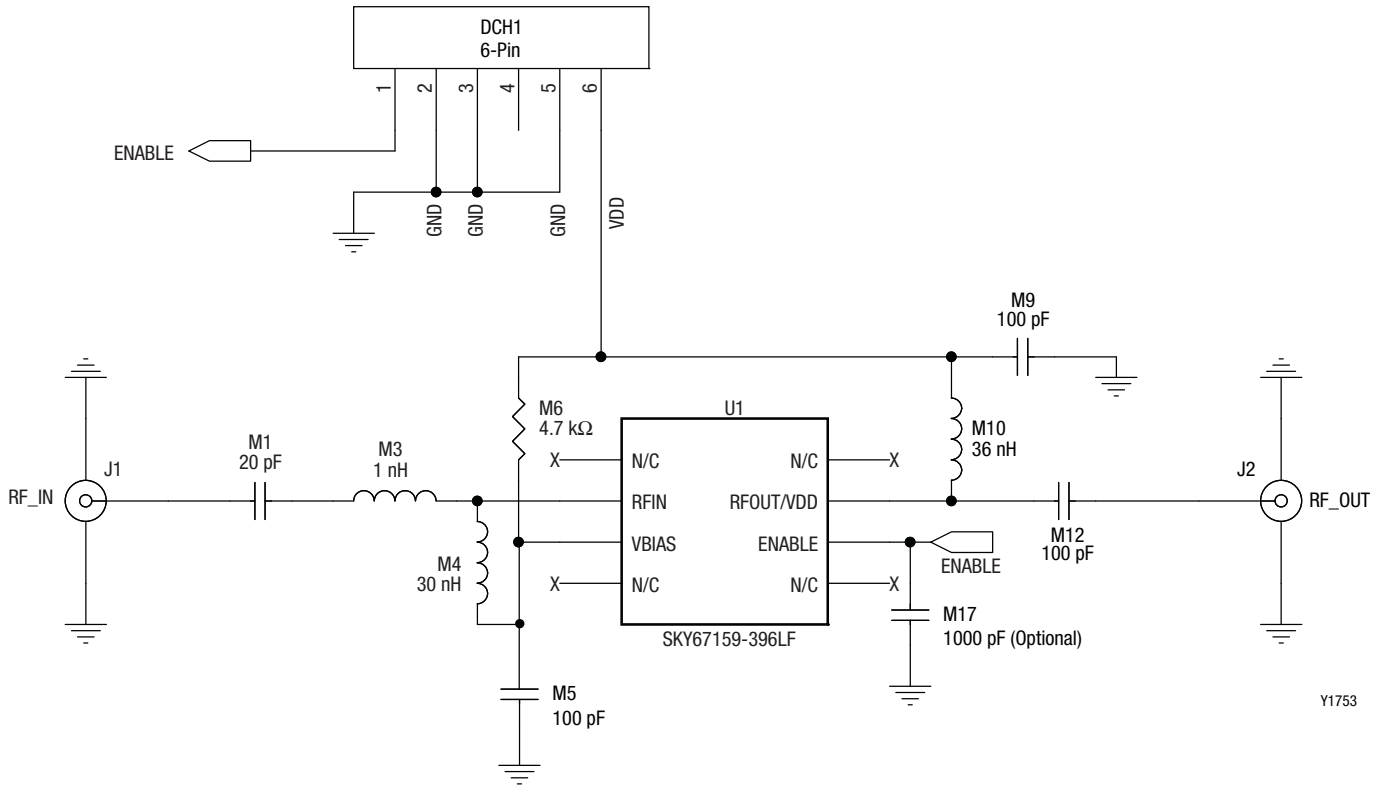
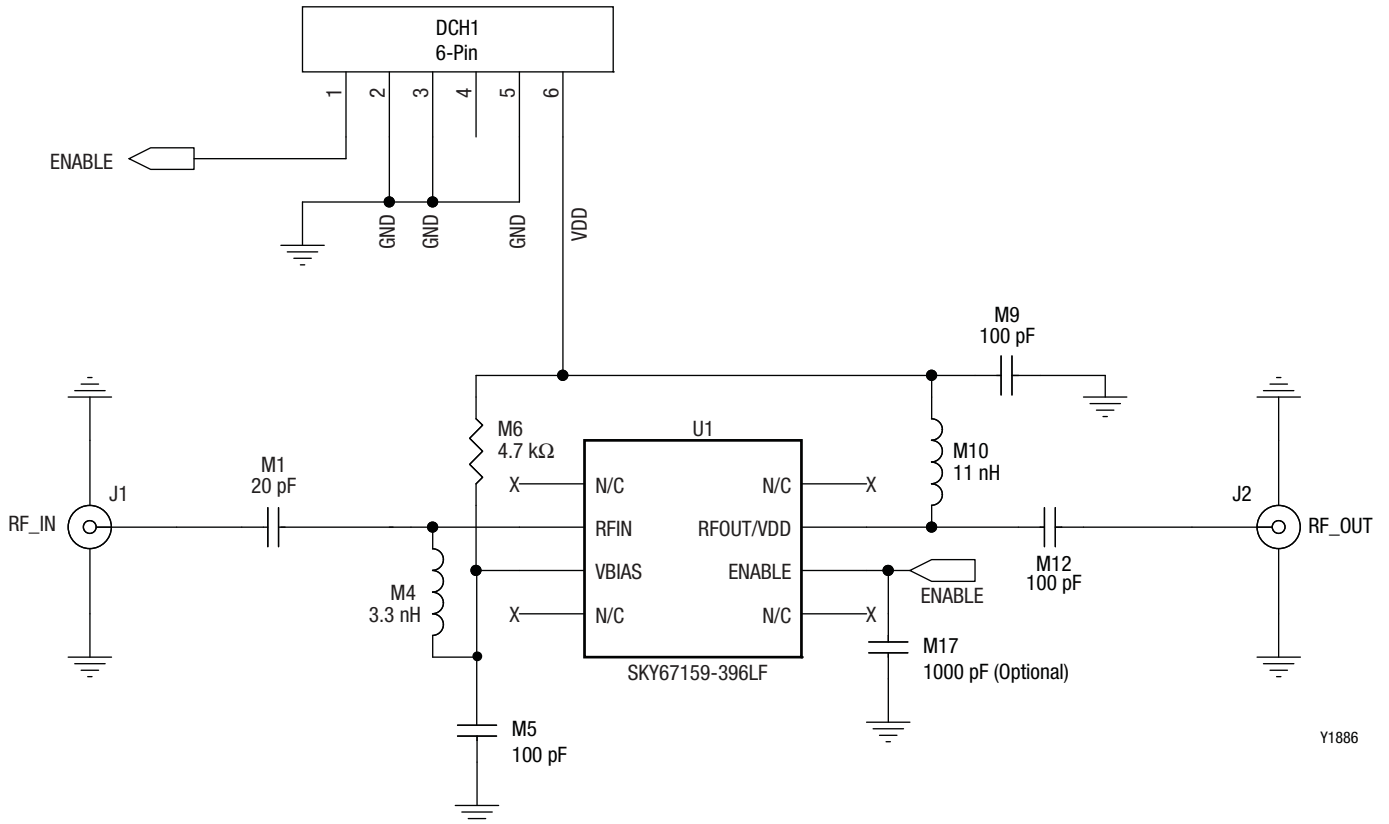

Figure 30. SKY67159-396LF Evaluation Board Schematic (Optimized for 700 to 2700 MHz)

Table 6. SKY67159-396LF Evaluation Board Bill of Materials (700 to 2700 MHz)

Component	Description	Value	Size	Manufacturer	Mfr Part Number
M1	Capacitor	20 pF	0402	Murata GJM	GJM1555C1H200JB01
M3	Inductor	1 nH	0402	Coilcraft HP	0402HP-1N0XJL
M4	Inductor	30 nH	0402	Coilcraft HP	0402HP-30NX_L_
M5, M9, M12	Capacitor	100 pF	0402	Murata GRM	GRM1555C1H101JA01D
M6 (RBIAS)	Resistor	4.7 kΩ	0402	Panasonic	ERJ-2RKF4701X
M10	Inductor	36 nH	0402	Coilcraft HP	0402HP-36NX_L_
M14, M16	Jumper	0 Ω	0402	Panasonic	ERJ-2GE0R00X
M2, M7, M8, M11, M13, M15, M17 ¹	DNP				

¹ M17 is optional. It is only needed if the control signal is noisy.



Y1886

Figure 31. SKY67159-396LF Evaluation Board Schematic (Optimized for 3400 to 3800 MHz)

Table 7. SKY67159-396LF Evaluation Board Bill of Materials (3400 to 3800 MHz)

Component	Description	Value	Size	Manufacturer	Part Number
M1	Capacitor	20 pF	0402	Murata GJM	GJM1555C1H200JB01
M4	Inductor	3.3 nH	0402	Coilcraft HP	0402HP-3N3X_L_
M5, M9, M12	Capacitor	100 pF	0402	Murata GRM	GRM1555C1H101JA01D
M6 (RBIAS)	Resistor	4.7 kΩ	0402	Panasonic	ERJ-2RKF4701X
M10	Inductor	11 nH	0402	Coilcraft HP	0402HP-11NX_L_
M3, M14, M16	Jumper	0 Ω	0402	Panasonic	ERJ-2GE0R00X
M2, M7, M8, M11, M13, M15, M17 ¹	DNP				

¹ M17 is optional. It is only needed if the control signal is noisy.

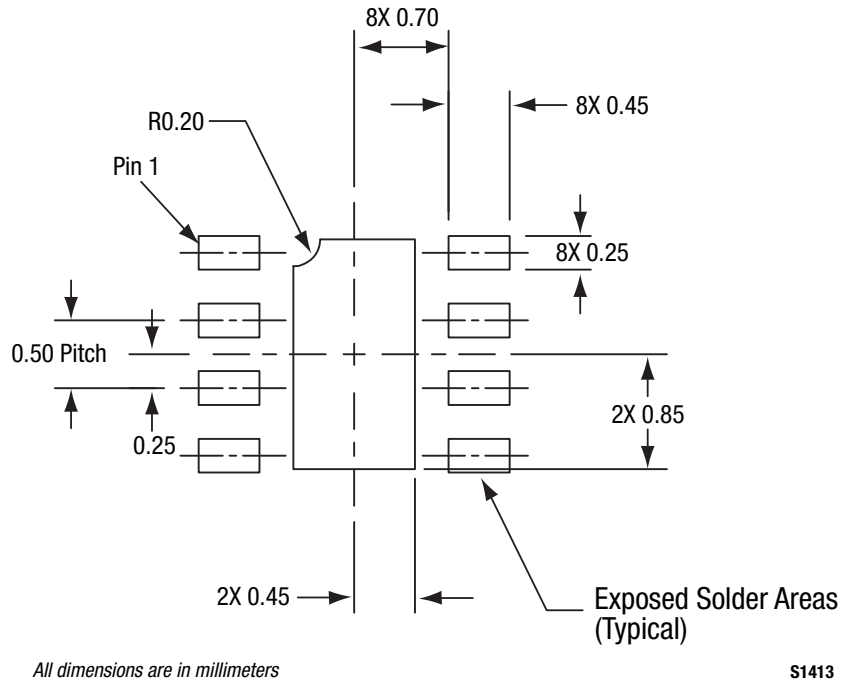

Figure 32. SKY67159-396LF PCB Layout Footprint (Top View)

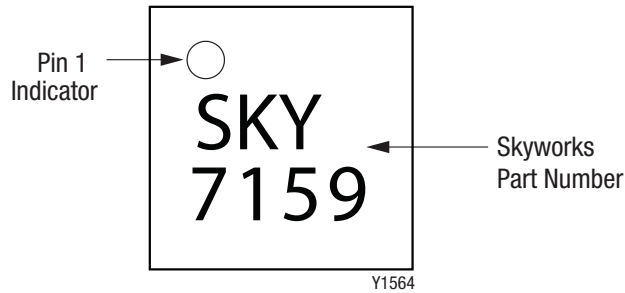
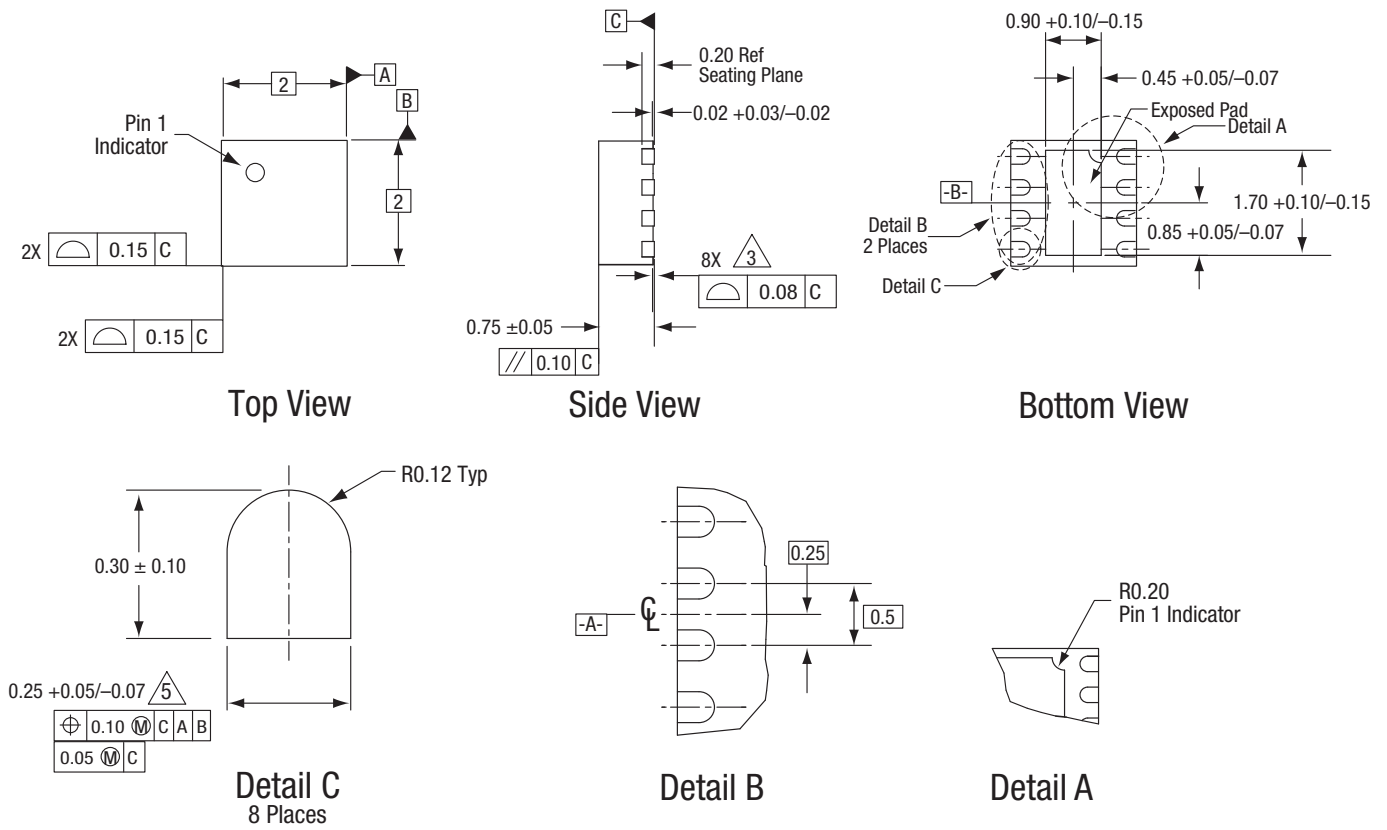

Figure 33. Typical Part Markings (Top View)



Notes:

1. All measurements are in millimeters.
2. Dimensions and tolerances according to ASME Y14.5M-1994.
3. Coplanarity applies to the exposed heat sink ground pad as well as the terminals.
4. Plating requirement per source control drawing (SCD) 2504.
5. Dimension applies to metallized terminal and is measured between 0.15 mm and 0.30 mm from terminal tip.

S1945

Figure 34. SKY67159-396LF Package Dimensions

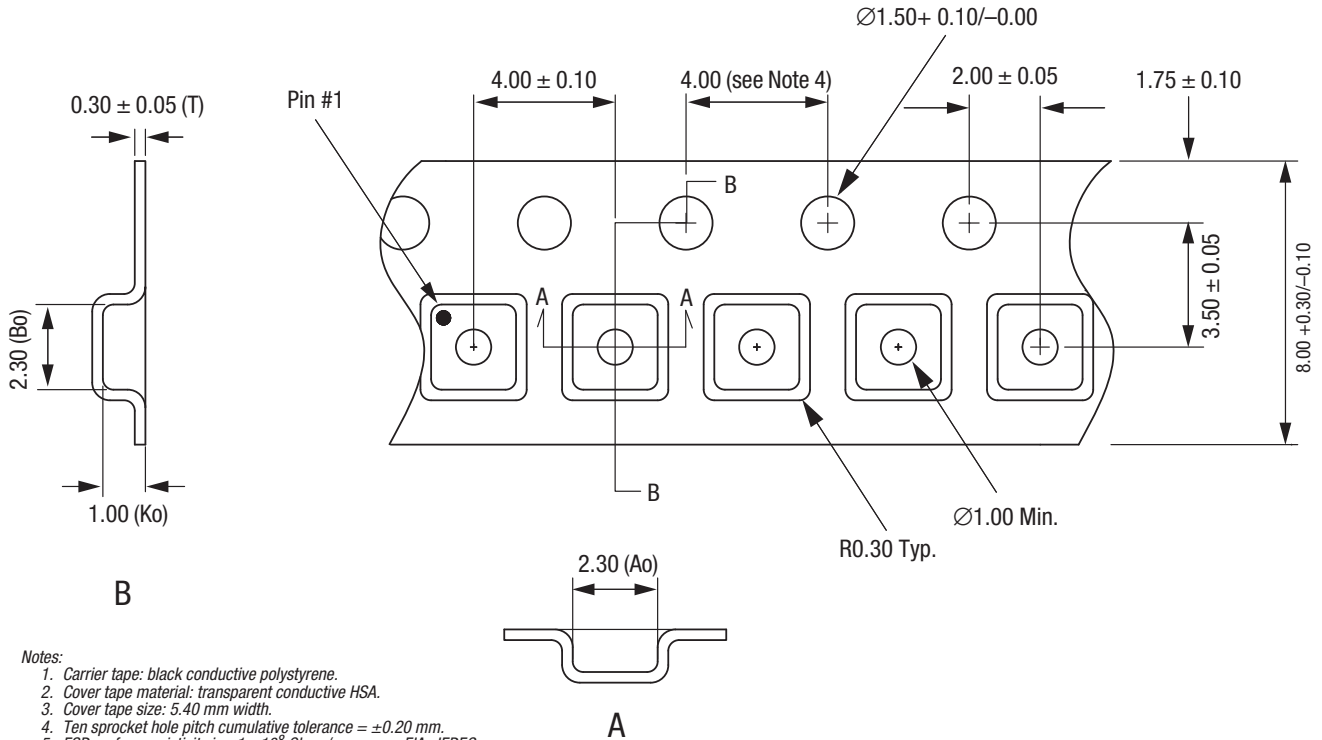

Notes:

1. Carrier tape: black conductive polystyrene.
2. Cover tape material: transparent conductive HSA.
3. Cover tape size: 5.40 mm width.
4. Ten sprocket hole pitch cumulative tolerance = ± 0.20 mm.
5. ESD surface resistivity is $\leq 1 \times 10^8$ Ohms/square per EIA, JEDEC tape and reel specification.
6. Ao and Bo measurement point to be 0.30 mm from bottom pocket.
7. All measurements are in millimeters.

S1601

Figure 35. SKY67159-396LF Tape and Reel Dimensions

Ordering Information

Part Number	Product Description	Evaluation Board Part Number
SKY67159-396LF LNA	200 to 3800 MHz Broadband Low-Noise Amplifier	SKY67159-396EK1 (700 to 2700 MHz low frequency range) SKY67159-396EK2 (3400 to 3800 MHz next frequency range)

Copyright © 2015, 2017-2018 Skyworks Solutions, Inc. All Rights Reserved.

Information in this document is provided in connection with Skyworks Solutions, Inc. (“Skyworks”) products or services. These materials, including the information contained herein, are provided by Skyworks as a service to its customers and may be used for informational purposes only by the customer. Skyworks assumes no responsibility for errors or omissions in these materials or the information contained herein. Skyworks may change its documentation, products, services, specifications or product descriptions at any time, without notice. Skyworks makes no commitment to update the materials or information and shall have no responsibility whatsoever for conflicts, incompatibilities, or other difficulties arising from any future changes.

No license, whether express, implied, by estoppel or otherwise, is granted to any intellectual property rights by this document. Skyworks assumes no liability for any materials, products or information provided hereunder, including the sale, distribution, reproduction or use of Skyworks products, information or materials, except as may be provided in Skyworks Terms and Conditions of Sale.

THE MATERIALS, PRODUCTS AND INFORMATION ARE PROVIDED “AS IS” WITHOUT WARRANTY OF ANY KIND, WHETHER EXPRESS, IMPLIED, STATUTORY, OR OTHERWISE, INCLUDING FITNESS FOR A PARTICULAR PURPOSE OR USE, MERCHANTABILITY, PERFORMANCE, QUALITY OR NON-INFRINGEMENT OF ANY INTELLECTUAL PROPERTY RIGHT; ALL SUCH WARRANTIES ARE HEREBY EXPRESSLY DISCLAIMED. SKYWORKS DOES NOT WARRANT THE ACCURACY OR COMPLETENESS OF THE INFORMATION, TEXT, GRAPHICS OR OTHER ITEMS CONTAINED WITHIN THESE MATERIALS. SKYWORKS SHALL NOT BE LIABLE FOR ANY DAMAGES, INCLUDING BUT NOT LIMITED TO ANY SPECIAL, INDIRECT, INCIDENTAL, STATUTORY, OR CONSEQUENTIAL DAMAGES, INCLUDING WITHOUT LIMITATION, LOST REVENUES OR LOST PROFITS THAT MAY RESULT FROM THE USE OF THE MATERIALS OR INFORMATION, WHETHER OR NOT THE RECIPIENT OF MATERIALS HAS BEEN ADVISED OF THE POSSIBILITY OF SUCH DAMAGE.

Skyworks products are not intended for use in medical, lifesaving or life-sustaining applications, or other equipment in which the failure of the Skyworks products could lead to personal injury, death, physical or environmental damage. Skyworks customers using or selling Skyworks products for use in such applications do so at their own risk and agree to fully indemnify Skyworks for any damages resulting from such improper use or sale.

Customers are responsible for their products and applications using Skyworks products, which may deviate from published specifications as a result of design defects, errors, or operation of products outside of published parameters or design specifications. Customers should include design and operating safeguards to minimize these and other risks. Skyworks assumes no liability for applications assistance, customer product design, or damage to any equipment resulting from the use of Skyworks products outside of stated published specifications or parameters.

Skyworks and the Skyworks symbol are trademarks or registered trademarks of Skyworks Solutions, Inc. or its subsidiaries in the United States and other countries. Third-party brands and names are for identification purposes only, and are the property of their respective owners. Additional information, including relevant terms and conditions, posted at www.skyworksinc.com, are incorporated by reference.

Данный компонент на территории Российской Федерации

Вы можете приобрести в компании MosChip.

Для оперативного оформления запроса Вам необходимо перейти по данной ссылке:

<http://moschip.ru/get-element>

Вы можете разместить у нас заказ для любого Вашего проекта, будь то серийное производство или разработка единичного прибора.

В нашем ассортименте представлены ведущие мировые производители активных и пассивных электронных компонентов.

Нашей специализацией является поставка электронной компонентной базы двойного назначения, продукции таких производителей как XILINX, Intel (ex.ALTERA), Vicor, Microchip, Texas Instruments, Analog Devices, Mini-Circuits, Amphenol, Glenair.

Сотрудничество с глобальными дистрибьюторами электронных компонентов, предоставляет возможность заказывать и получать с международных складов практически любой перечень компонентов в оптимальные для Вас сроки.

На всех этапах разработки и производства наши партнеры могут получить квалифицированную поддержку опытных инженеров.

Система менеджмента качества компании отвечает требованиям в соответствии с ГОСТ Р ИСО 9001, ГОСТ РВ 0015-002 и ЭС РД 009

Офис по работе с юридическими лицами:

105318, г.Москва, ул.Щербаковская д.3, офис 1107, 1118, ДЦ «Щербаковский»

Телефон: +7 495 668-12-70 (многоканальный)

Факс: +7 495 668-12-70 (доб.304)

E-mail: info@moschip.ru

Skype отдела продаж:

moschip.ru

moschip.ru_4

moschip.ru_6

moschip.ru_9