

Features and applications for SMD PTC thermistors

Features

- Qualification based on AEC-Q200, Rev. D
- Reflow soldering only
- Certified to IEC 60738-1 and IEC 60730-1, annex J15 and J17
- Fast and reliable response
- RoHS-compatible
- UL approval to UL1434
- Lead-free tinned terminations for case sizes 0603 and 0805
- Lead-free ceramics for case sizes 0402 and 0805

Applications

- Over-temperature protection of power components
- DC/DC converters
- SMPS, adapters
- Notebooks, game consoles
- Lighting: LED lights, dimmers, ballasts
- Automotive LED lighting
- Li-Ion battery pack protection
- Hifi amplifiers

Application circuit examples

Over-temperature detection circuit and its output voltage

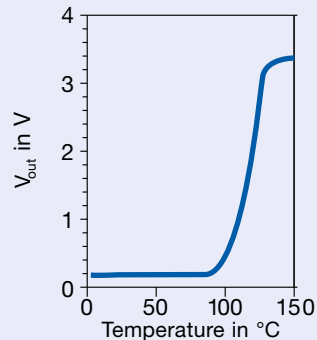
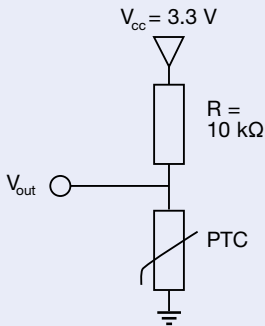

Example of over-temperature detection for multiple hot spots

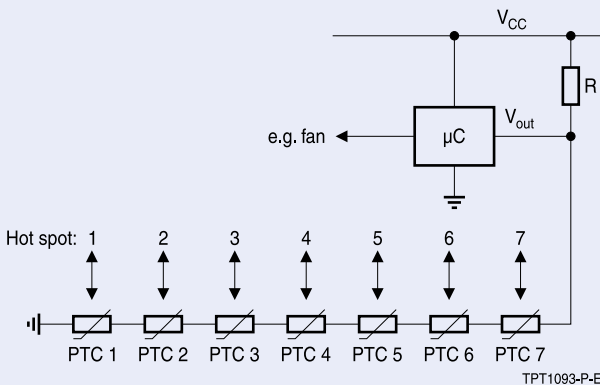

Components

EIA 0402 75 °C	EIA 0402 85 °C	EIA 0402 95 °C	EIA 0402 105 °C	EIA 0402 115 °C	EIA 0402 125 °C	EIA 0402 135 °C		
-------------------	-------------------	-------------------	--------------------	--------------------	--------------------	--------------------	--	--

EIA 0603 75 °C	EIA 0603 85 °C	EIA 0603 95 °C	EIA 0603 105 °C	EIA 0603 115 °C	EIA 0603 125 °C	EIA 0603 135 °C	EIA 0603 145 °C	
-------------------	-------------------	-------------------	--------------------	--------------------	--------------------	--------------------	--------------------	--

EIA 0805 70 °C	EIA 0805 80 °C	EIA 0805 90 °C	EIA 0805 100 °C	EIA 0805 110 °C	EIA 0805 120 °C	EIA 0805 130 °C		
-------------------	-------------------	-------------------	--------------------	--------------------	--------------------	--------------------	--	--

Electrical specifications and ordering codes

EIA case size	$T_{\text{sense},1}$ (@ 4.7 k Ω) [°C]	$T_{\text{sense},2}$ (@ 47 k Ω) [°C]	R_R ($V \leq V_{\text{max}}$) [Ω]	ΔR_R [%]	Ordering code		
Superior series, case size 0402							
0402	75 \pm 5	–	470	\pm 50	B59421A0075A062		
0402	85 \pm 5	–	470	\pm 50	B59421A0085A062		
0402	95 \pm 5	–	470	\pm 50	B59421A0095A062		
0402	105 \pm 5	–	470	\pm 50	B59421A0105A062		
0402	115 \pm 5	–	470	\pm 50	B59421A0115A062		
0402	125 \pm 5	–	470	\pm 50	B59421A0125A062		
0402	135 \pm 5	–	470	\pm 50	B59421A0135A062		
Superior series, case size 0603							
0603	75 \pm 5	–	470	\pm 50	B59641A0075A062		
0603	85 \pm 5	100 \pm 7	470	\pm 50	B59641A0085A062		
0603	95 \pm 5	110 \pm 7	470	\pm 50	B59641A0095A062		
0603	105 \pm 5	120 \pm 7	470	\pm 50	B59641A0105A062		
0603	115 \pm 5	130 \pm 7	470	\pm 50	B59641A0115A062		
0603	125 \pm 5	140 \pm 7	470	\pm 50	B59641A0125A062		
0603	135 \pm 5	150 \pm 7	470	\pm 50	B59641A0135A062		
0603	145 \pm 5	–	470	\pm 50	B59641A0145A062		
Superior series, case size 0805							
EIA case size	$T_{\text{sense},1}$ [°C]	R_R ($V \leq V_{\text{max}}$) [Ω]	ΔR_R [%]	R ($T_{\text{sense},1} - 5^\circ\text{C}$) [k Ω]	R ($T_{\text{sense},1} + 5^\circ\text{C}$) [k Ω]	R ($T_{\text{sense},1} + 15^\circ\text{C}$) [k Ω]	Ordering code
0805	70	680	\pm 50	≤ 5.7	≤ 5.7	–	B59721A0070A062
0805	80	680	\pm 50	≤ 5.7	≤ 5.7	–	B59721A0080A062
0805	90	680	\pm 50	≤ 5.5	≤ 13.3	≥ 40	B59721A0090A062
0805	100	680	\pm 50	≤ 5.5	≤ 13.3	≥ 40	B59721A0100A062
0805	110	680	\pm 50	≤ 5.5	≤ 13.3	≥ 40	B59721A0110A062
0805	120	680	\pm 50	≤ 5.5	≤ 13.3	≥ 40	B59721A0120A062
0805	130	680	\pm 50	≤ 5.5	≤ 13.3	≥ 40	B59721A0130A062

Important information: Some parts of this publication contain statements about the suitability of our products for certain areas of application. These statements are based on our knowledge of typical requirements that are often placed on our products. We expressly point out that these statements cannot be regarded as binding statements about the suitability of our products for a particular customer application. It is incumbent on the customer to check and decide whether a product is suitable for use in a particular application. This publication is only a brief product survey which may be changed from time to time. Our products are described in detail in our data sheets. The *Important notes* (www.epcos.com/ImportantNotes) and the product-specific *Cautions and warnings* must be observed. All relevant information is available through our sales offices.

Dimensional drawings in mm

EIA case size 0402

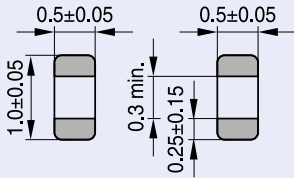

Termination

TPT0948-M-E

Solder pad

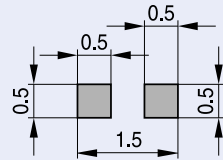

TPT0949-V

Recommended maximum dimensions

EIA case size 0603

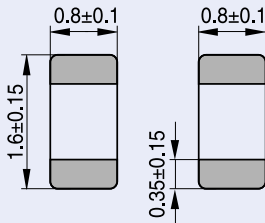

Termination

TPT0698-5-E

Solder pad

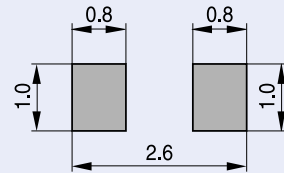

TPT0899-A

Recommended maximum dimensions

EIA case size 0805

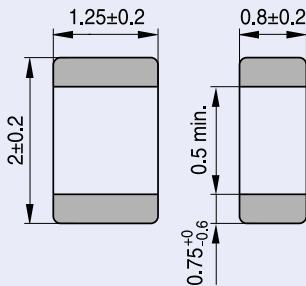

Termination

TPT0650-F-E

Solder pad

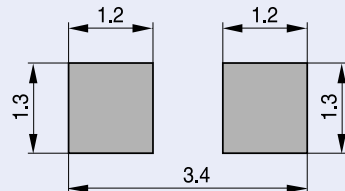

TPT0870-7

Recommended maximum dimensions

Mouser Electronics

Authorized Distributor

Click to View Pricing, Inventory, Delivery & Lifecycle Information:

[EPCOS / TDK:](#)

[B59001Z0999A099](#)

Данный компонент на территории Российской Федерации

Вы можете приобрести в компании MosChip.

Для оперативного оформления запроса Вам необходимо перейти по данной ссылке:

<http://moschip.ru/get-element>

Вы можете разместить у нас заказ для любого Вашего проекта, будь то серийное производство или разработка единичного прибора.

В нашем ассортименте представлены ведущие мировые производители активных и пассивных электронных компонентов.

Нашей специализацией является поставка электронной компонентной базы двойного назначения, продукции таких производителей как XILINX, Intel (ex.ALTERA), Vicor, Microchip, Texas Instruments, Analog Devices, Mini-Circuits, Amphenol, Glenair.

Сотрудничество с глобальными дистрибьюторами электронных компонентов, предоставляет возможность заказывать и получать с международных складов практически любой перечень компонентов в оптимальные для Вас сроки.

На всех этапах разработки и производства наши партнеры могут получить квалифицированную поддержку опытных инженеров.

Система менеджмента качества компании отвечает требованиям в соответствии с ГОСТ Р ИСО 9001, ГОСТ РВ 0015-002 и ЭС РД 009

Офис по работе с юридическими лицами:

105318, г.Москва, ул.Щербаковская д.3, офис 1107, 1118, ДЦ «Щербаковский»

Телефон: +7 495 668-12-70 (многоканальный)

Факс: +7 495 668-12-70 (доб.304)

E-mail: info@moschip.ru

Skype отдела продаж:

moschip.ru

moschip.ru_4

moschip.ru_6

moschip.ru_9