

Small Signal Product

Switching Diode

FEATURES

- Fast switching speed
- Surface device type mounting
- Moisture sensitivity level 1
- High conductance power dissipation
- For general purpose switching applications
- Pb free version and RoHS compliant
- Packing code with suffix "G" means green compound (halogen-free)

SOT-363

MECHANICAL DATA

- Case: SOT-363 small outline plastic package
- Terminal: Matte tin plated, lead free., solderable per MIL-STD-202, Method 208 guaranteed
- High temperature soldering guaranteed : 260°C/10s

MAXIMUM RATINGS AND ELECTRICAL CHARACTERISTICS (T _A =25°C unless otherwise noted)				
PARAMETER	SYMBOL	VALUE	UNIT	
Power Dissipation	P _D	200	mW	
Repetitive Peak Reverse Voltage	V _{RRM}	80	V	
Reverse Voltage	V _R	57	V	
Average Rectified Forward Current	I _{F(AV)}	500	mA	
Average Rectified Output Current	I _O	250	mA	
Non-Repetitive Peak Forward Surge Current	I _{FSM}	@ t = 1 μs	4	A
		@ t = 1 s	1.5	
Thermal Resistance (Junction to Ambient)	R _{θJA}	625	°C/W	
Junction and Storage Temperature Range	T _J , T _{STG}	-55 to 150	°C	

PARAMETER	SYMBOL	MIN	MAX	UNIT	
Reverse Breakdown Voltage	V _(BR)	80	-	V	
Forward Voltage	V _F	I _R =100μA	0.620	0.715	V
		I _F =5.0mA	-	0.855	
		I _F =10mA	-	1.000	
		I _F =100mA	-	1.250	
Reverse Leakage Current	V _F	V _R =70V	-	100	nA
		V _R =75V, T _J =150°C	-	50	μA
		V _R =25V, T _J =150°C	-	30	μA
		V _R =20V	-	25	nA
Junction Capacitance	C _J	-	3.5	pF	
Reverse Recovery Time	t _{rr}	-	4.0	ns	

Note 1: Device mounted on FR-4 PCB, 1 inch × 0.85 inch × 0.062 inch

Note 2: Short duration test pulse used to minimize self-heating effect

Small Signal Product

ORDERING INFORMATION

PART NO.	PACKING CODE	PACKING CODE SUFFIX	PACKAGE	PACKING
MBD4448Hxxx (Note 1, 2)	RE	G	SOT-363	3K / 7" Reel

Note 1: "xxx" is Device Code from "AQW" - "TW"

Note 2: Whole series with green compound

EXAMPLE

PREFERRED P/N	PART NO.	PACKING CODE	PACKING CODE SUFFIX	DESCRIPTION
MBD4448HTW REG	MBD4448HTW	RE	G	Green compound

DIMENSIONS

SOT-363

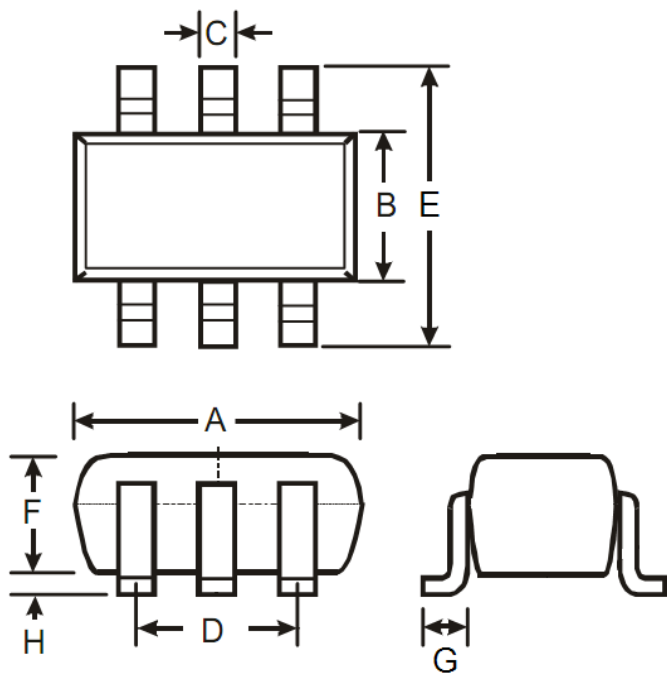

DIM.	Unit (mm)		Unit (inch)	
	Min	Max	Min	Max
A	2.00	2.20	0.079	0.087
B	1.15	1.35	0.045	0.053
C	0.15	0.35	0.006	0.014
D	1.20	1.40	0.047	0.055
E	2.15	2.45	0.085	0.096
F	0.85	1.05	0.033	0.041
G	0.25	0.46	0.010	0.018
H	0.00	0.10	0.000	0.004

SUGGESTED PAD LAYOUT

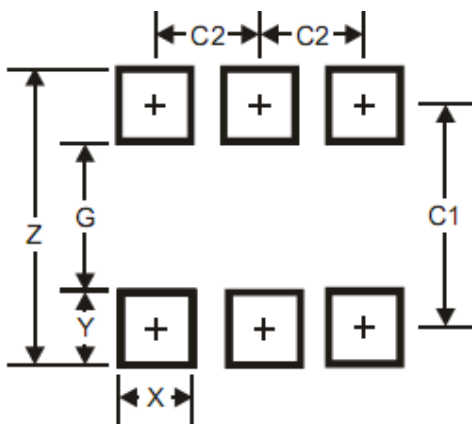

DIM.	Unit (mm)		Unit (inch)	
	Typ.		Typ.	
Z	2.50		0.098	
G	1.30		0.051	
X	0.42		0.017	
Y	0.60		0.024	
C1	1.90		0.075	
C2	0.65		0.026	

Small Signal Product

PIN CONFIGURATION

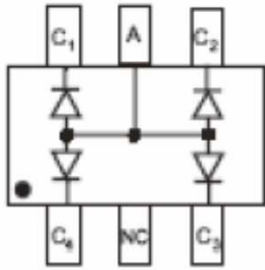

MBD4448HAQW

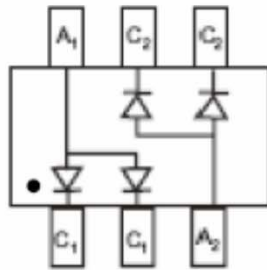

MBD4448HADW

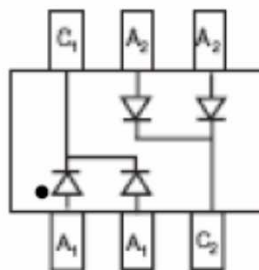

MBD4448HCDW

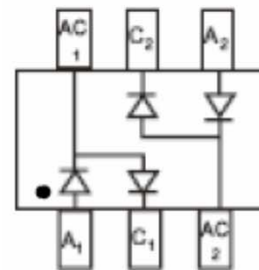

MBD4448HSDW

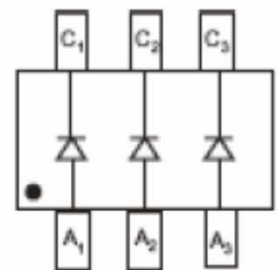

MBD4448HTW

MARKING

Part no.	Marking code
MBD4448HAQW	KA5
MBD4448HADW	KA6
MBD4448HCDW	KA7
MBD4448HSDW	KA8
MBD4448HTW	KAA

Small Signal Product

Notice

Specifications of the products displayed herein are subject to change without notice. TSC or anyone on its behalf, assumes no responsibility or liability for any errors or inaccuracies.

Information contained herein is intended to provide a product description only. No license, express or implied, to any intellectual property rights is granted by this document. Except as provided in TSC's terms and conditions of sale for such products, TSC assumes no liability whatsoever, and disclaims any express or implied warranty, relating to sale and/or use of TSC products including liability or warranties relating to fitness for a particular purpose, merchantability, or infringement of any patent, copyright, or other intellectual property right.

The products shown herein are not designed for use in medical, life-saving, or life-sustaining applications. Customers using or selling these products for use in such applications do so at their own risk and agree to fully indemnify TSC for any damages resulting from such improper use or sale.

Данный компонент на территории Российской Федерации

Вы можете приобрести в компании MosChip.

Для оперативного оформления запроса Вам необходимо перейти по данной ссылке:

<http://moschip.ru/get-element>

Вы можете разместить у нас заказ для любого Вашего проекта, будь то серийное производство или разработка единичного прибора.

В нашем ассортименте представлены ведущие мировые производители активных и пассивных электронных компонентов.

Нашей специализацией является поставка электронной компонентной базы двойного назначения, продукции таких производителей как XILINX, Intel (ex.ALTERA), Vicor, Microchip, Texas Instruments, Analog Devices, Mini-Circuits, Amphenol, Glenair.

Сотрудничество с глобальными дистрибьюторами электронных компонентов, предоставляет возможность заказывать и получать с международных складов практически любой перечень компонентов в оптимальные для Вас сроки.

На всех этапах разработки и производства наши партнеры могут получить квалифицированную поддержку опытных инженеров.

Система менеджмента качества компании отвечает требованиям в соответствии с ГОСТ Р ИСО 9001, ГОСТ РВ 0015-002 и ЭС РД 009

Офис по работе с юридическими лицами:

105318, г.Москва, ул.Щербаковская д.3, офис 1107, 1118, ДЦ «Щербаковский»

Телефон: +7 495 668-12-70 (многоканальный)

Факс: +7 495 668-12-70 (доб.304)

E-mail: info@moschip.ru

Skype отдела продаж:

moschip.ru

moschip.ru_4

moschip.ru_6

moschip.ru_9