

## STELLA-A

Type II and III beam for street lighting.  
Compatible with up to 23 mm LES size COBs.  
Variant with black frame.

### TECHNICAL SPECIFICATIONS:

Dimensions	Ø 90.0 mm
Height	22 mm
Fastening	screw
ROHS compliant	yes ⓘ

### MATERIAL SPECIFICATIONS:

Component	Type	Material	Colour	Finish
STELLA-A	Single lens	Silicone	clear	
STELLA-FRAME	Holder	PA66	black	



### ORDERING INFORMATION:

Component		Qty in box	MOQ	MPQ	Box weight (kg)
FN13323_STELLA-A	Single lens	100	50	10	6.6
» Box size:					

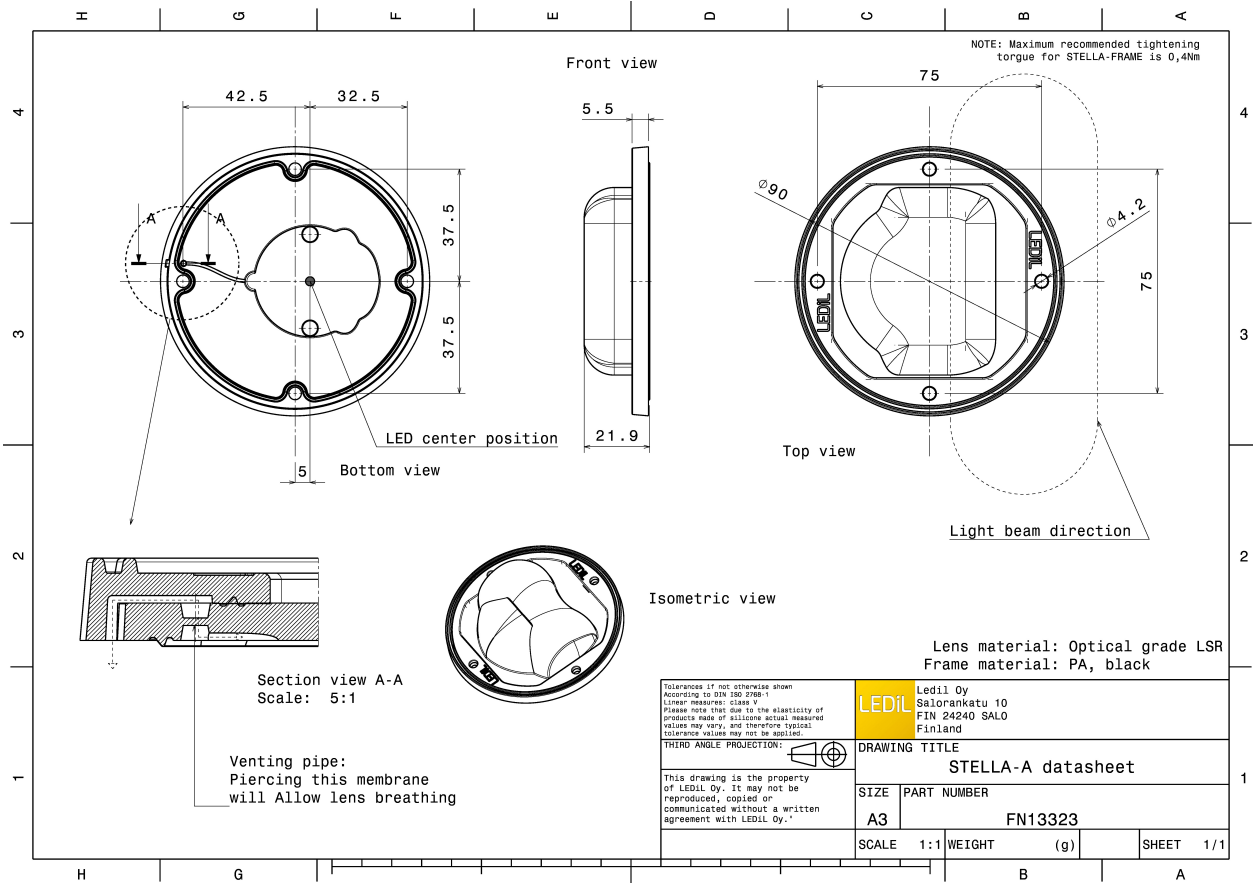

### PHOTOMETRIC DATA (MEASURED):

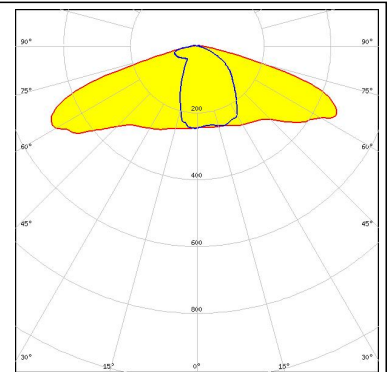
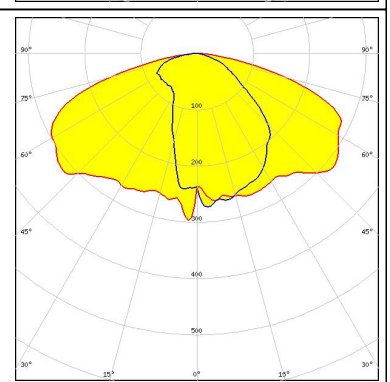
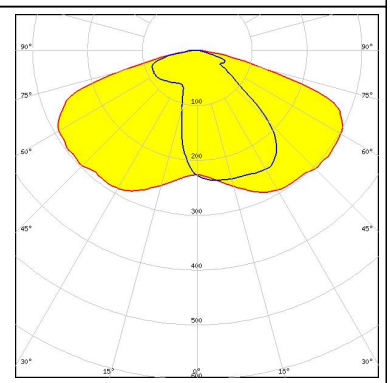
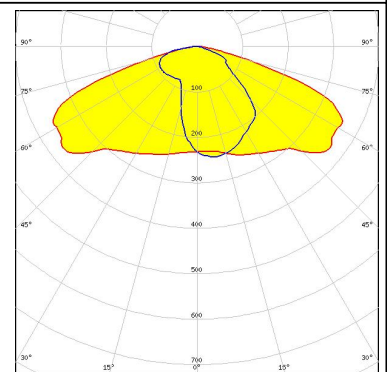
<p>bridgelux.</p> <p>LED V15 Gen6 FWHM Asymmetric Efficiency 91 % Peak intensity 0.6 cd/lm LEDs/each optic 1 Light colour White Required components:</p>	
<p>bridgelux.</p> <p>LED V18 Gen7 FWHM Asymmetric Efficiency 85 % Peak intensity 0.4 cd/lm LEDs/each optic 1 Light colour White Required components:</p>	
<p>bridgelux.</p> <p>LED VERO13 FWHM Asymmetric Efficiency 92 % Peak intensity 0.7 cd/lm LEDs/each optic 1 Light colour White Required components:</p>	
<p>bridgelux.</p> <p>LED VERO18 FWHM Asymmetric Efficiency 92 % Peak intensity 0.5 cd/lm LEDs/each optic 1 Light colour White Required components:</p>	

### PHOTOMETRIC DATA (MEASURED):

#### CITIZEN

LED CLL03x/CLU03x  
 FWHM Asymmetric  
 Efficiency 92 %  
 Peak intensity 0.6 cd/lm  
 LEDs/each optic 1  
 Light colour White  
 Required components:  
 Bender Wirth: 433 Typ L1

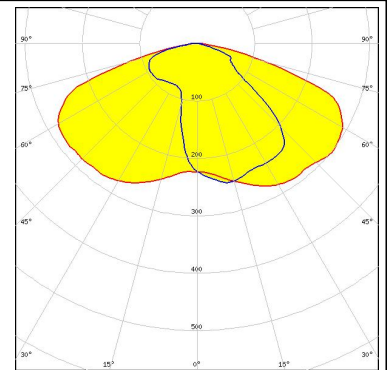
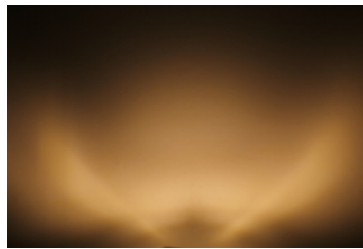

#### CITIZEN

LED CLU700/701/702  
 FWHM Asymmetric  
 Efficiency 89 %  
 Peak intensity 1.4 cd/lm  
 LEDs/each optic 1  
 Light colour White  
 Required components:  
 Bender Wirth: 434 Typ L1

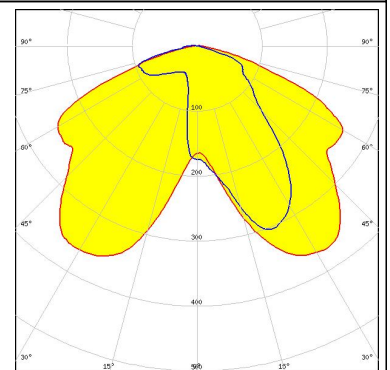
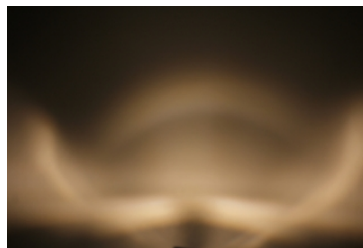

#### CITIZEN

LED CLU710/711  
 FWHM Asymmetric  
 Efficiency 89 %  
 Peak intensity 1 cd/lm  
 LEDs/each optic 1  
 Light colour White  
 Required components:

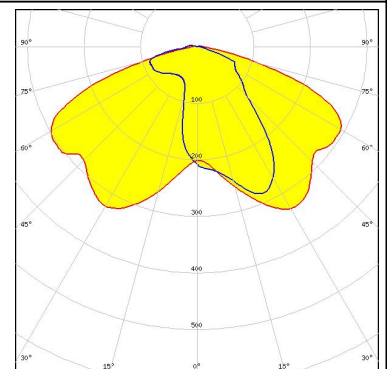

#### CITIZEN

LED CLU720/721  
 FWHM Asymmetric  
 Efficiency 91 %  
 Peak intensity 0.8 cd/lm  
 LEDs/each optic 1  
 Light colour White  
 Required components:  
 Bender Wirth: 433 Typ L1

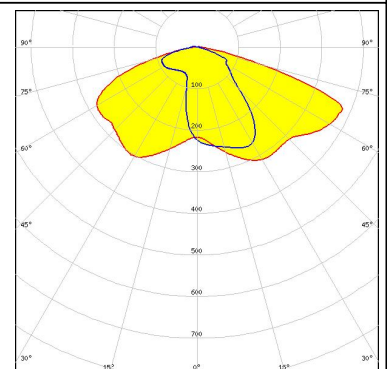
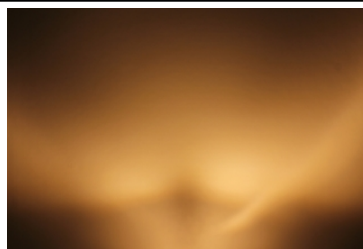

#### PHOTOMETRIC DATA (MEASURED):

#### CITIZEN

LED CLU720/721  
 FWHM Asymmetric  
 Efficiency %  
 Peak intensity 0.7 cd/lm  
 LEDs/each optic 1  
 Light colour White  
 Required components:

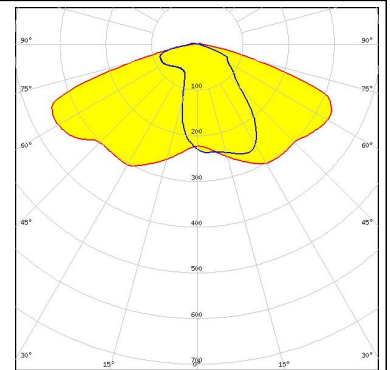

#### CREE

LED CXA/B 15xx  
 FWHM Asymmetric  
 Efficiency 92 %  
 Peak intensity 0.9 cd/lm  
 LEDs/each optic 1  
 Light colour White  
 Required components:  
 Bender Wirth: 441 Typ L1

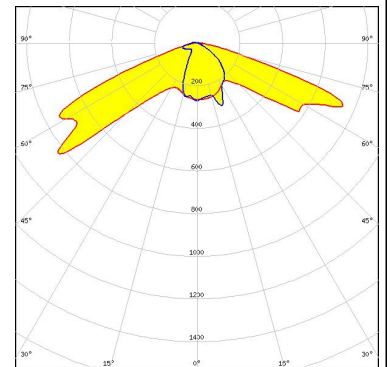
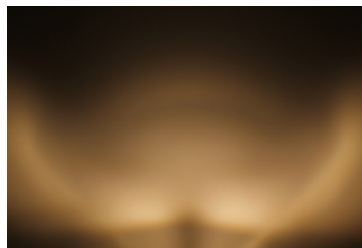

#### CREE

LED CXA/B 15xx  
 FWHM Asymmetric  
 Efficiency 89 %  
 Peak intensity 1 cd/lm  
 LEDs/each optic 1  
 Light colour White  
 Required components:  
 C14305\_STELLA-CLAMP-CXA15-18

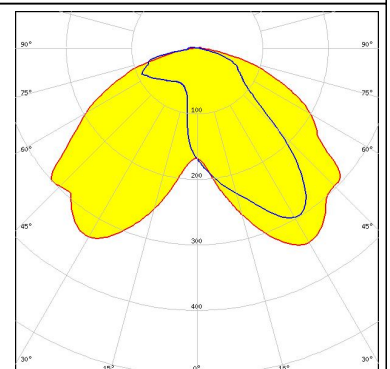

#### CREE

LED CXA/B 15xx  
 FWHM Asymmetric  
 Efficiency 92 %  
 Peak intensity 1.1 cd/lm  
 LEDs/each optic 1  
 Light colour White  
 Required components:

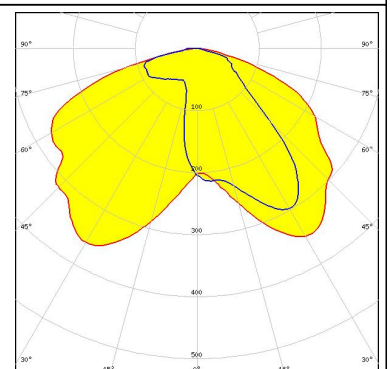

#### PHOTOMETRIC DATA (MEASURED):

#### CREE

LED CXA/B 1816 & CXA/B 1820 & CXA 1850  
 FWHM Asymmetric  
 Efficiency 87 %  
 Peak intensity 0.7 cd/lm  
 LEDs/each optic 1  
 Light colour White  
 Required components:

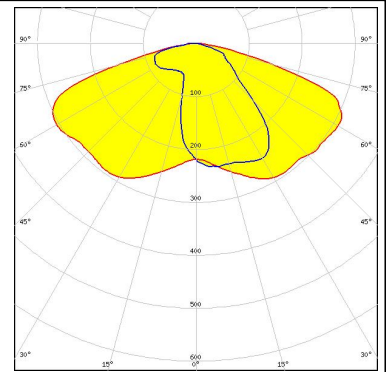

#### CREE

LED CXA/B 1816 & CXA/B 1820 & CXA 1850  
 FWHM Asymmetric  
 Efficiency 92 %  
 Peak intensity 0.7 cd/lm  
 LEDs/each optic 1  
 Light colour White  
 Required components:  
 C14305\_STELLA-CLAMP-CXA15-18

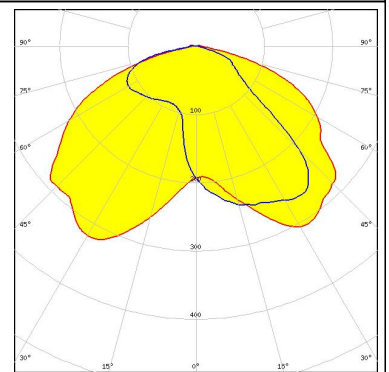

#### CREE

LED CXA/B 1816 & CXA/B 1820 & CXA 1850  
 FWHM Asymmetric  
 Efficiency 89 %  
 Peak intensity 0.7 cd/lm  
 LEDs/each optic 1  
 Light colour White  
 Required components:  
 Bender Wirth: 437 Typ L1

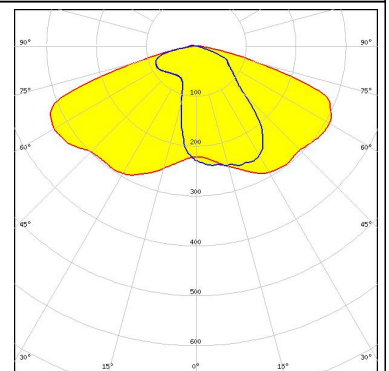

#### CREE

LED CXA/B 1816 & CXA/B 1820 & CXA 1850  
 FWHM Asymmetric  
 Efficiency 87 %  
 Peak intensity 0.6 cd/lm  
 LEDs/each optic 1  
 Light colour White  
 Required components:

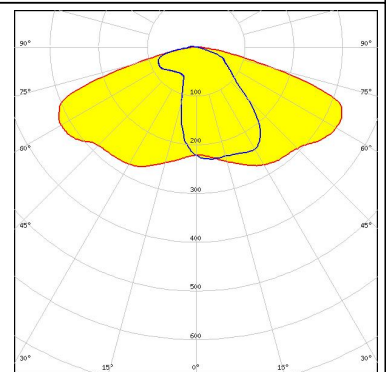

#### PHOTOMETRIC DATA (MEASURED):



LED CXA/B 25xx  
 FWHM Asymmetric  
 Efficiency 93 %  
 Peak intensity 0.5 cd/lm  
 LEDs/each optic 1  
 Light colour White  
 Required components:

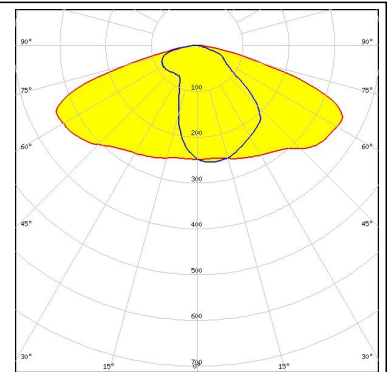

LED LUXEON CoB 1202/1203  
 FWHM Asymmetric  
 Efficiency 88 %  
 Peak intensity 0.9 cd/lm  
 LEDs/each optic 1  
 Light colour White  
 Required components:  
 Bender Wirth: 438 Typ L1

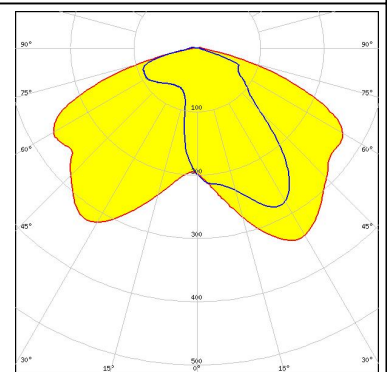

LED LUXEON CoB 1208  
 FWHM Asymmetric  
 Efficiency %  
 Peak intensity 0.3 cd/lm  
 LEDs/each optic 1  
 Light colour White  
 Required components:

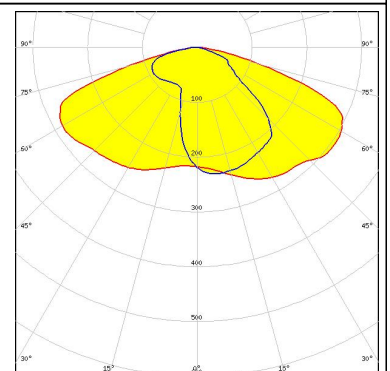

LED CxM-14 (19x19)  
 FWHM Asymmetric  
 Efficiency 90 %  
 Peak intensity 0.6 cd/lm  
 LEDs/each optic 1  
 Light colour White  
 Required components:

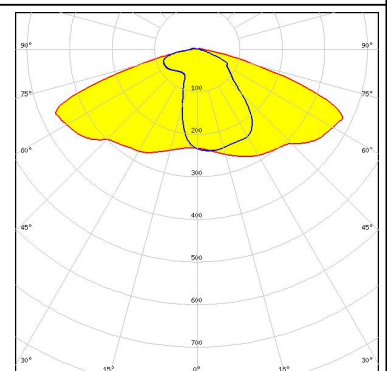

### PHOTOMETRIC DATA (MEASURED):



LED CxM-18 (21.5x21.5)  
 FWHM Asymmetric  
 Efficiency 89 %  
 Peak intensity 0.5 cd/lm  
 LEDs/each optic 1  
 Light colour White  
 Required components:

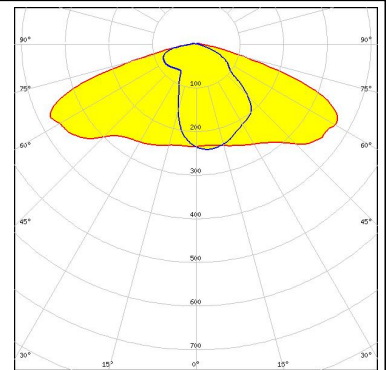

LED COB J-Type  
 FWHM Asymmetric  
 Efficiency 87 %  
 Peak intensity 0.5 cd/lm  
 LEDs/each optic 1  
 Light colour White  
 Required components:

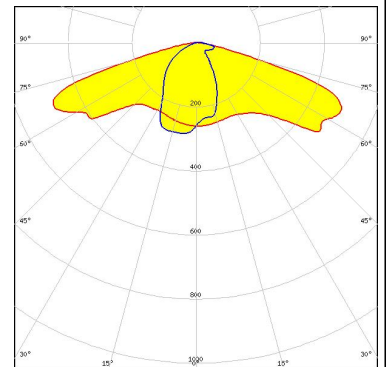

LED COB L-Type (LES 11)  
 FWHM Asymmetric  
 Efficiency 89 %  
 Peak intensity 0.7 cd/lm  
 LEDs/each optic 1  
 Light colour White  
 Required components:  
 Bender Wirth: 438 Typ L1

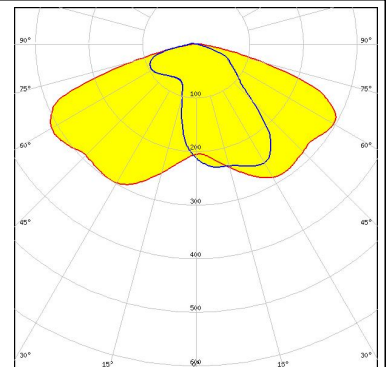

LED COB L-Type (LES 9)  
 FWHM Asymmetric  
 Efficiency 90 %  
 Peak intensity 0.9 cd/lm  
 LEDs/each optic 1  
 Light colour White  
 Required components:  
 Bender Wirth: 438 Typ L1

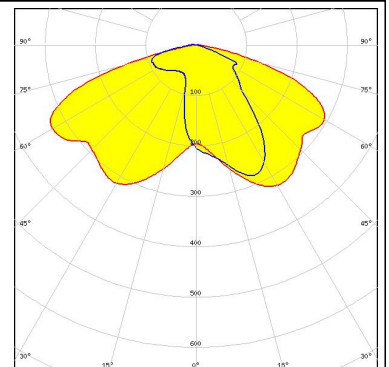



### PHOTOMETRIC DATA (MEASURED):

#### OSRAM

Opto Semiconductors

LED Soleriq S13  
FWHM Asymmetric  
Efficiency 91 %  
Peak intensity 0.7 cd/lm  
LEDs/each optic 1  
Light colour White  
Required components:

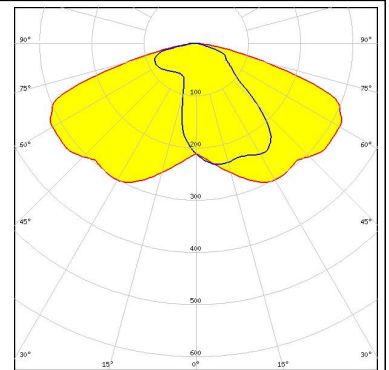

#### OSRAM

Opto Semiconductors

LED Soleriq S13  
FWHM Asymmetric  
Efficiency 92 %  
Peak intensity 0.7 cd/lm  
LEDs/each optic 1  
Light colour White  
Required components:  
Bender Wirth: 437 Typ L1

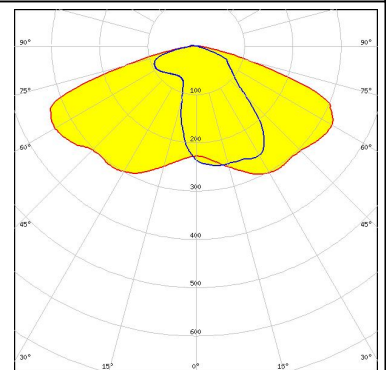

#### OSRAM

Opto Semiconductors

LED Soleriq S19  
FWHM Asymmetric  
Efficiency 90 %  
Peak intensity 0.5 cd/lm  
LEDs/each optic 1  
Light colour White  
Required components:

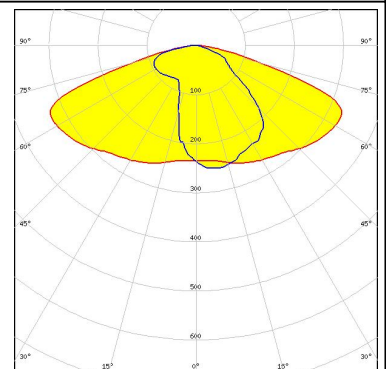

#### SAMSUNG

LED LC016D / LC019D / LC026D / LC033D  
FWHM Asymmetric  
Efficiency 87 %  
Peak intensity 0.5 cd/lm  
LEDs/each optic 1  
Light colour White  
Required components:

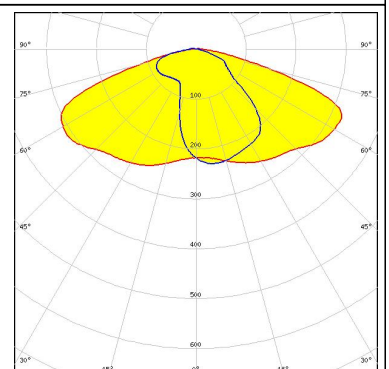



## PHOTOMETRIC DATA (MEASURED):

### SHARP

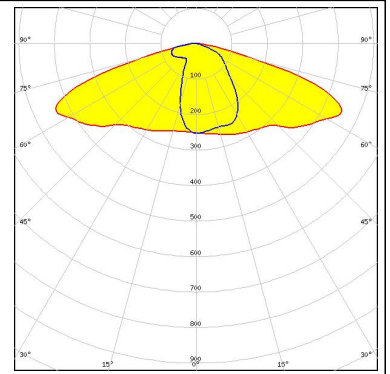
LED Mega Zenigata (GW6DME)  
FWHM Asymmetric  
Efficiency 90 %  
Peak intensity 0.6 cd/lm  
LEDs/each optic 1  
Light colour White  
Required components:

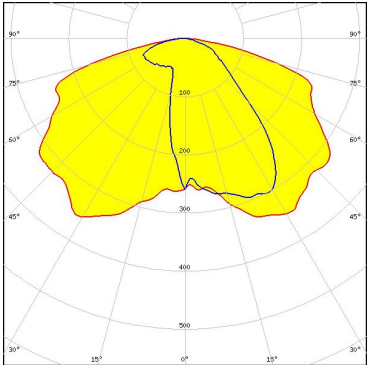

### PHOTOMETRIC DATA (SIMULATED):

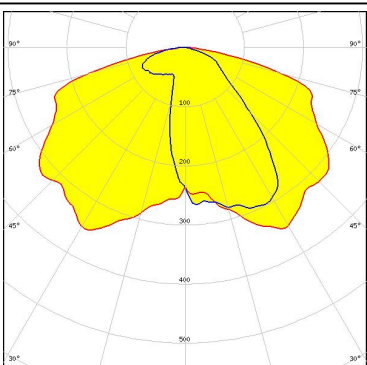
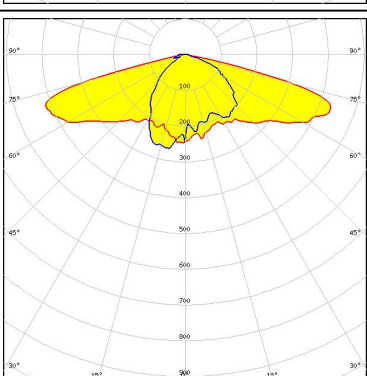
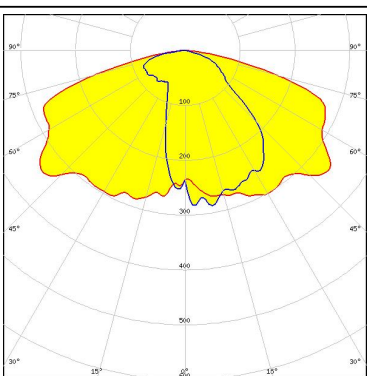
<p> <b>bridgelux</b></p> <p>LED V10 Gen7            FWHM Asymmetric            Efficiency 89 %            Peak intensity 0.6 cd/lm            LEDs/each optic 1            Light colour White            Required components:            Bender Wirth: 486 Typ L1</p>	
<p> <b>bridgelux</b></p> <p>LED V13 Gen7            FWHM Asymmetric            Efficiency 89 %            Peak intensity 0.6 cd/lm            LEDs/each optic 1            Light colour White            Required components:            Bender Wirth: 477 Typ L1</p>	
<p><b>CITIZEN</b></p> <p>LED CLL02x/CLU02x (LES10)            FWHM Asymmetric            Efficiency 91 %            Peak intensity 0.7 cd/lm            LEDs/each optic 1            Light colour White            Required components:</p>	
<p><b>CITIZEN</b></p> <p>LED CLL03x/CLU03x            FWHM Asymmetric            Efficiency 90 %            Peak intensity 0.5 cd/lm            LEDs/each optic 1            Light colour White            Required components:</p>	

### GENERAL INFORMATION:

NOTE: The typical beam angle will be changed by different color, chip size and chip position tolerance. The typical total beam angle is the full angle measured where the luminous intensity is half of the peak value.

Due to use of high power COB's with this product, special attention to proper thermal design is highly recommended. LEDiL has no liability for direct, indirect or consecutive damages arising from the LEDiL products being used outside of the recommended temperature range.

### MATERIALS:

As part of our continuous research and improvement processes, and to ensure the best possible quality and availability of our products, LEDiL reserves the right to change material grades without notice.

### PRODUCT DATA USER AGREEMENT AND DISCLAIMER:

The measured data in the provided downloadable LEDiL Product Datasheets and Mechanical 2D-Drawings is rounded and provided as reference for planning. LEDiL Oy's optical specifications have been verified by conducting performance testing of the products in accordance with the company's quality system. The reported data are averaged results of multiple measurements with typical variation. LEDiL Oy reserves the right to without prior notification make changes and improvements to its products.

LEDiL Oy assumes neither warranty, nor guarantee nor any other liability of any kind for the contents and correctness of the provided data. The provided data has been generated with highest diligence but the provided data may in reality not represent the complete possible variation range of all intrinsic parameters. Therefore, in certain cases a deviation from the provided data could occur.

LEDiL Oy reserves the right to undertake technical changes of its products without further notification which could lead to changes in the provided data. LEDiL Oy assumes no liability of any kind for the possible deviation from any provided data or any other damage resulting from the usage of the provided data.

The user agrees to this disclaimer and user agreement with the download or usage of the provided files.

#### LEDiL Oy

Joensuunkatu 13  
FI-24240 SALO  
Finland

#### LEDiL Inc.

228 West Page Street  
Suite D  
Sycamore IL 60178  
USA

#### Local sales and technical support

[www.ledil.com/  
where\\_to\\_buy](http://www.ledil.com/where_to_buy)

#### Shipping locations

Salo, Finland  
Hong Kong, China

#### Distribution Partners

[www.ledil.com/  
where\\_to\\_buy](http://www.ledil.com/where_to_buy)

## Данный компонент на территории Российской Федерации

### Вы можете приобрести в компании MosChip.

Для оперативного оформления запроса Вам необходимо перейти по данной ссылке:

<http://moschip.ru/get-element>

Вы можете разместить у нас заказ для любого Вашего проекта, будь то серийное производство или разработка единичного прибора.

В нашем ассортименте представлены ведущие мировые производители активных и пассивных электронных компонентов.

Нашей специализацией является поставка электронной компонентной базы двойного назначения, продукции таких производителей как XILINX, Intel (ex.ALTERA), Vicor, Microchip, Texas Instruments, Analog Devices, Mini-Circuits, Amphenol, Glenair.

Сотрудничество с глобальными дистрибьюторами электронных компонентов, предоставляет возможность заказывать и получать с международных складов практически любой перечень компонентов в оптимальные для Вас сроки.

На всех этапах разработки и производства наши партнеры могут получить квалифицированную поддержку опытных инженеров.

Система менеджмента качества компании отвечает требованиям в соответствии с ГОСТ Р ИСО 9001, ГОСТ РВ 0015-002 и ЭС РД 009

### Офис по работе с юридическими лицами:

105318, г.Москва, ул.Щербаковская д.3, офис 1107, 1118, ДЦ «Щербаковский»

Телефон: +7 495 668-12-70 (многоканальный)

Факс: +7 495 668-12-70 (доб.304)

E-mail: [info@moschip.ru](mailto:info@moschip.ru)

Skype отдела продаж:

moschip.ru

moschip.ru\_4

moschip.ru\_6

moschip.ru\_9