

FIG 1
JSOM-0515-01 SHOWN

BOARD STACK HEIGHT
-0515, -0715, *0815, -0865,
-1015, *-1100, -1215, -1524

LEAD STYLE
-01: PRESS-IN (NOT AVAILABLE FOR -0715,
-0815, -0865, -1015, -1215 & -1524
BOARD STACK HEIGHTS)
-02: THREADED (NOT AVAILABLE FOR -0515
& -1100 BOARD STACK HEIGHTS)
(SEE SHT 2, FIG 3)

* = NOT TOOLED

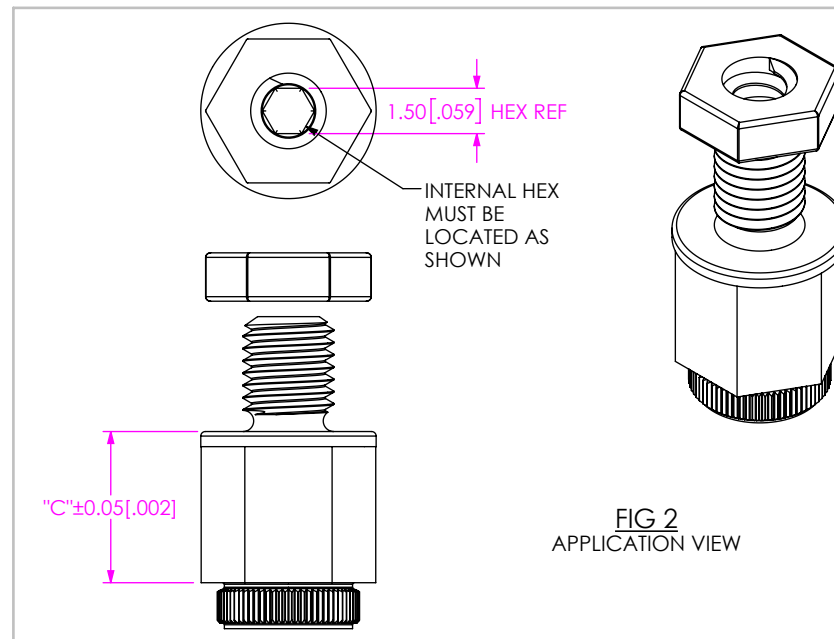

FIG 2
APPLICATION VIEW

FINISHED GOOD	STAND-OFF BASE	JACK SCREW	SCREW	NUT	"A"	"B"	"C"
JSOM-0515-01	JSOM-B-04.65-01	JSOM-T-00.50-02	N/A	SN-01-02	8.80 [0.346]	4.65 [0.183]	5.150 [0.2028]
JSOM-0715-02	JSOM-B-06.65-02	JSOM-T-00.50-01	MS-01-02-L		7.80 [0.307]	6.65 [0.262]	7.150 [0.2815]
*JSOM-0815-02	*JSOM-B-07.65-02	JSOM-T-00.50-02	MS-01-02-L		8.80 [0.346]	7.65 [0.301]	8.150 [0.3209]
JSOM-0865-02	JSOM-B-08.15-02	JSOM-T-00.50-02	MS-01-02-L		8.80 [0.346]	8.15 [0.321]	8.650 [0.3406]
JSOM-1015-02	JSOM-B-09.65-02	JSOM-T-00.50-02	MS-01-02-L		8.80 [0.346]	9.65 [0.380]	10.150 [0.3996]
*JSOM-1100-01	*JSOM-B-07.76-01	JSOM-T-03.24-03	N/A		15.04 [0.592]	7.76 [0.306]	11.000 [0.4331]
JSOM-1215-02	JSOM-B-11.65-02	JSOM-T-00.50-02	MS-01-02-L		8.80 [0.346]	11.65 [0.459]	12.150 [0.4783]
JSOM-1524-02	JSOM-B-12.00-02	JSOM-T-03.24-03	MS-01-02-L		15.04 [0.592]	12.00 [0.472]	15.240 [0.6000]

(* = NOT TOOLED)

QTY = 1 FOR ALL COMPONENTS

NOTES:

1. REPRESENTS CRITICAL DIMENSION
2. STANDOFFS TO BE USED WITH 1.57[0.062]MIN THICK BOARDS.
3. COMPONENTS ARE TO BE BULK PACKAGED IN SEPARATE BAGS AND SHOULD NOT LIST INDIVIDUAL COMPONENT QUANTITY ON THE LABEL. ALL COMPONENT BAGS ARE TO BE PACKAGED IN A LARGER BAG WITH THE FINAL PART NUMBER QUANTITY OF ASSEMBLIES ON THE LABEL.
4. STANDOFFS ARE DESIGNED 0.15MM LONGER THAN CONNECTOR STACK HEIGHTS TO ALLOW FOR PROCESSING VARIABLES.
5. TORQUE TO 2.5 – 3.5 IN*lbs TO SECURE FASTENER IN A STATIC ENVIRONMENT ASSUMING RECOMMENDED BOARD TO BOARD DISTANCES ARE ACHIEVED WITHOUT DAMAGE TO THE PCB, HARDWARE OR OTHER COMPONENTS.

UNLESS OTHERWISE SPECIFIED,
DIMENSIONS ARE IN MILLIMETERS.
TOLERANCES ARE:
DECIMALS ANGLES
X.X: ±0.3 [01] 2°
X.XX: ±0.13 [005]
X.XXX: ±0.051 [0020]

PROPRIETARY NOTE
THIS DOCUMENT CONTAINS CONFIDENTIAL AND PROPRIETARY INFORMATION AND ALL DESIGN, MANUFACTURING, REPRODUCTION, USE, PATENT RIGHTS AND SALES RIGHTS ARE EXPRESSLY RESERVED BY SAMTEC, INC. THIS DOCUMENT SHALL NOT BE DISCLOSED, IN WHOLE OR PART, TO ANY UNAUTHORIZED PERSON OR ENTITY NOR REPRODUCED, TRANSFERRED OR INCORPORATED IN ANY OTHER PROJECT IN ANY MANNER WITHOUT THE EXPRESS WRITTEN CONSENT OF SAMTEC, INC.

MATERIAL: DO NOT SCALE DRAWING SHEET SCALE: 4:1
STAINLESS STEEL



520 PARK EAST BLVD, NEW ALBANY, IN 47150
PHONE: 812-944-6733 FAX: 812-948-5047
e-Mail: info@SAMTEC.com code 53322

DESCRIPTION:
MICRO JACK SCREW STAND-OFF
DWG. NO.
JSOM-XXXX-XX
BY: JESSIE W 7/28/2015 SHEET 1 OF 2

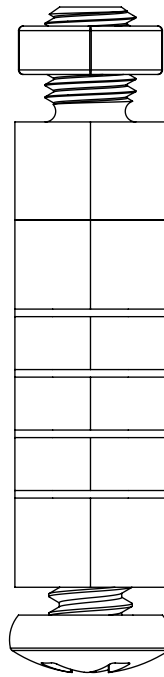
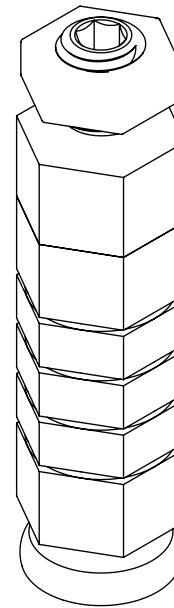
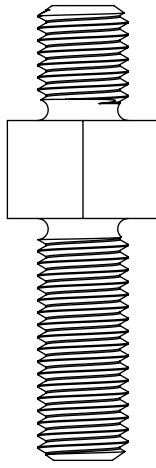
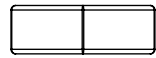

"C" ±0.05 [.002]
(SEE TABLE 1, SHT 1)

JSOM-B-XX.XX-02

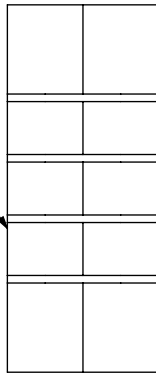

MS-01-02-L

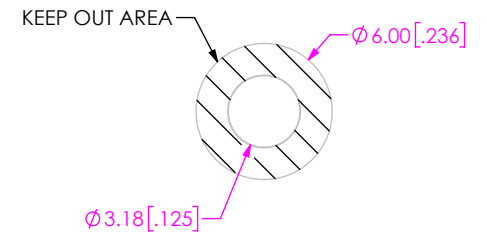
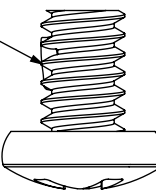

FOR -01 & -02 JACK SCREW

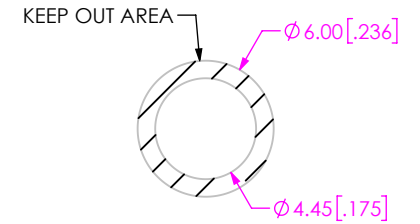

FOR -01 PRESS-IN

RECOMMENDED BOARD CUTOUT

FIG 3
JSOM-1524-02
(DIFFERENT AS SHOWN, OTHERWISE SAME AS FIG 1)

PROPRIETARY NOTE
THIS DOCUMENT CONTAINS CONFIDENTIAL AND PROPRIETARY INFORMATION AND ALL DESIGN, MANUFACTURING, REPRODUCTION, USE, PATENT RIGHTS AND SALES RIGHTS ARE EXPRESSLY RESERVED BY SAMTEC, INC. THIS DOCUMENT SHALL NOT BE DISCLOSED, IN WHOLE OR PART, TO ANY UNAUTHORIZED PERSON OR ENTITY NOR REPRODUCED, TRANSFERRED OR INCORPORATED IN ANY OTHER PROJECT IN ANY MANNER WITHOUT THE EXPRESS WRITTEN CONSENT OF SAMTEC, INC.

DO NOT SCALE DRAWING

SHEET SCALE: 3:1



520 PARK EAST BLVD, NEW ALBANY, IN 47150
PHONE: 812-944-6733 FAX: 812-948-5047
e-Mail info@SAMTEC.com code 55322

DESCRIPTION: MICRO JACK SCREW STAND-OFF

DWG. NO. JSOM-XXXX-XX

BY: JESSIE W 7/28/2015 SHEET 2 OF 2

Данный компонент на территории Российской Федерации

Вы можете приобрести в компании MosChip.

Для оперативного оформления запроса Вам необходимо перейти по данной ссылке:

<http://moschip.ru/get-element>

Вы можете разместить у нас заказ для любого Вашего проекта, будь то серийное производство или разработка единичного прибора.

В нашем ассортименте представлены ведущие мировые производители активных и пассивных электронных компонентов.

Нашей специализацией является поставка электронной компонентной базы двойного назначения, продукции таких производителей как XILINX, Intel (ex.ALTERA), Vicor, Microchip, Texas Instruments, Analog Devices, Mini-Circuits, Amphenol, Glenair.

Сотрудничество с глобальными дистрибьюторами электронных компонентов, предоставляет возможность заказывать и получать с международных складов практически любой перечень компонентов в оптимальные для Вас сроки.

На всех этапах разработки и производства наши партнеры могут получить квалифицированную поддержку опытных инженеров.

Система менеджмента качества компании отвечает требованиям в соответствии с ГОСТ Р ИСО 9001, ГОСТ РВ 0015-002 и ЭС РД 009

Офис по работе с юридическими лицами:

105318, г.Москва, ул.Щербаковская д.3, офис 1107, 1118, ДЦ «Щербаковский»

Телефон: +7 495 668-12-70 (многоканальный)

Факс: +7 495 668-12-70 (доб.304)

E-mail: info@moschip.ru

Skype отдела продаж:

moschip.ru

moschip.ru_4

moschip.ru_6

moschip.ru_9