

PLEASE CHECK WWW.MOLEX.COM FOR LATEST PART INFORMATION

Part Number: [0340813003](#)
Status: **Active**
Overview: [mx150 sealed connector system](#)
Description: MX150™ Female Cable Seal Terminal, Gold (Au) Plating, 14-16 AWG, Left Reel Payoff, Contact Material Thickness 0.30mm (.012")

Documents:

[Drawing \(PDF\)](#) [RoHS Certificate of Compliance \(PDF\)](#)

General

Product Family	Crimp Terminals
Series	34081
Comments	Left Reel Payoff, Cable Seal
Crimp Quality Equipment	Yes
Overview	mx150 sealed connector system
Product Name	MX150™

Physical

Gender	Female
Material - Metal	High Performance Alloy (HPA)
Material - Plating Mating	Gold
Material - Plating Termination	Tin
Packaging Type	Reel
Plating min: Mating (µin)	30.4
Plating min: Mating (µm)	0.76
Plating min: Termination (µin)	100
Plating min: Termination (µm)	2.5
Termination Interface: Style	Crimp or Compression
Wire Insulation Diameter	2.60mm (.102") max.
Wire Size AWG	14, 16
Wire Size mm²	1.5

Electrical

Current - Maximum per Contact	22A
Voltage - Maximum	250V

Material Info

Reference - Drawing Numbers

Sales Drawing	SD-34083-002
---------------	--------------

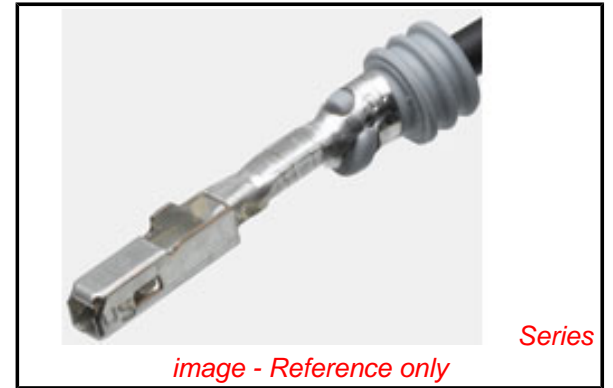

EU RoHS

ELV and RoHS Compliant
REACH SVHC Contains SVHC: No
Halogen-Free Status

China RoHS



Need more information on product environmental compliance?

Email productcompliance@molex.com
 For a multiple part number RoHS Certificate of Compliance, [click here](#)

Please visit the [Contact Us](#) section for any non-product compliance questions.

Search Parts in this Series

[34081Series](#)

Use With

[33471](#) Single Row Sealed Connector, [33472](#) Dual Row Sealed Connector, [33476](#) Dual Row Hybrid Sealed Connector, [34062](#) Single Row 2-Way Cable Sealed Connector, [34250](#) Single Row 3-Way Cable Sealed Connector

Application Tooling | FAQ

Tooling specifications and manuals are found by selecting the products below. Crimp Height Specifications are then contained in the Application Tooling Specification document.

Global

Description	Product #
Manual Extraction Tool	0638131500
Hand Crimp Tool For MX150 Cable Seal Crimp Terminals	0638199000

Hand Crimp Tool For 0638199100
MX150 Cable Seal
Crimp Terminals
Fine Adjust 0639018000
Applicator for
MX150™ Cable Seal
Crimp Terminals

This document was generated on 05/19/2010

PLEASE CHECK WWW.MOLEX.COM FOR LATEST PART INFORMATION

STAMP PLATING TYPE (Au-GOLD),
(Sn-TIN) OR (Ag-SILVER) IN THIS AREA

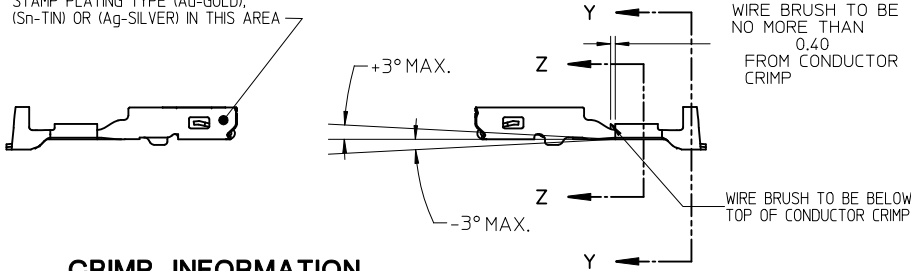

CRIMP INFORMATION
SEE TABLE 1 ON SHEET 2

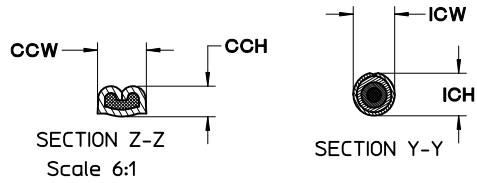

SILVER PLATING:
BASE LAYER:
ELECTRODEPOSITED DUCTILE SULFATE NICKEL
THICKNESS: 1.25 - 2.25 MICROMETERS

SILVER LAYER:
ZONE A1 AND ZONE A2
ELECTRODEPOSITED PURE SILVER (IMPURITIES 0.5% MAX)
FINISH: SEMI-BRIGHT
THICKNESS: 1.9 - 3.3 MICROMETERS

ANTI-TARNISH TREATMENT FOR SILVER PLATED TERMINALS:
EVABRITE WS

ZONE B:
TIN PLATING: PER MOLEX ES-88 REVISION: REL

THICKNESS 1 (1.25 - 2.25 MICROMETERS)
ELECTRODEPOSITED SULFAMATE DUCTILE NICKEL (BASE LAYER)

THICKNESS 2 (2.50 - 4.00 MICROMETERS) ELECTRODEPOSITED
TIN (100% TIN) MATTE FINISH

PLATING NOTES:

1. TIN PLATING: (ENTIRE TERMINAL)

THICKNESS 1 (0.25-1.00 MICROMETERS)
ELECTRODEPOSITED ADVANCED TIN BARRIER (BASE LAYER)

THICKNESS 2 (0.50-1.00 MICROMETERS)
ELECTRODEPOSITED REFLOW TIN (100% TIN, NO BRIGHTENERS)

PLATING INFORMATION

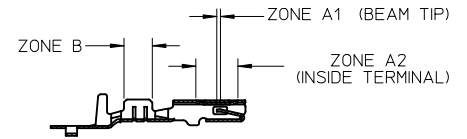

SECTION A-A

GOLD PLATING NOTES:

ZONE A1 AND ZONE A2:
PER MOLEX ES-88 REVISION:REL

THICKNESS 1 (1.25 - 2.25 MICROMETERS)
ELECTRODEPOSITED SULFAMATE DUCTILE NICKEL (BASE LAYER)

THICKNESS 2 (0.76 MICROMETERS MINIMUM)
ELECTRODEPOSITED GOLD CAP

ZONE B:
TIN PLATING: PER MOLEX ES-88 REVISION:REL

THICKNESS 1 (1.25-2.25 MICROMETERS)
ELECTRODEPOSITED SULFAMATE DUCTILE NICKEL (BASE LAYER)

THICKNESS 2 (2.50 - 4.00 MICROMETERS) ELECTRODEPOSITED
TIN (100% TIN) MATTE FINISH

NOTES: (UNLESS OTHERWISE SPECIFIED)

- MATING TERMINAL SHOWN ON MOLEX DRAWING SD-34080-001
- MATERIAL: ASTM B422, UNS C19025, HR04
THICKNESS: 0.30 mm +0.01
TEMPER: FULL HARD (REF)
TENSILE: 496 MIN MPA
PLATING: SEE PLATING NOTES
- MEETS PERFORMANCE SPECIFICATION FOR CABLE TO TERMINAL
ELECTRICAL CRIMPS PER SAE/USCAR-21 (8/2001)
- MEETS PERFORMANCE STANDARD FOR AUTOMOTIVE ELECTRICAL
CONNECTOR SYSTEMS FOR SAE/USCAR-2, REV. 4 (TEMP CLASS 3)
(4/2001)
- MEETS ELECTRICAL CONNECTION SYSTEM DESIGN SPECIFICATION
(SDS) REV.11 (5/2002)
- MEETS FIELD CORRELATED LIFE TEST (FCLT) PER
SAE/USCAR-20 (11/2001)

- INSERTION FORCE WITH INLINE BLADE
AVG FROM PV TESTING = 3.5 N TIN (REFERENCE)
3.1 N GOLD (REFERENCE)
- REFERENCE PK-31300-516 FOR REEL DIRECTION
- REFERENCE CS-34083-002 FOR ADDITIONAL
CRIMP INFORMATION

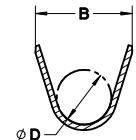

SECTION B-B
Scale 5:1

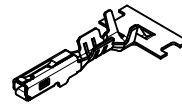
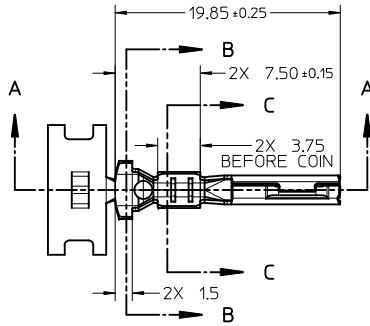

SCALE 2:1

SEE TABLE 2 ON SHEET 3
FOR CHARTED DIM.

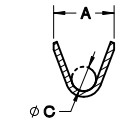

SECTION C-C
Scale 5:1

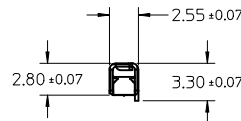
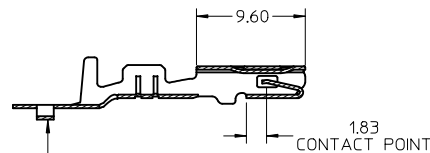

CARRIER BUMP DIRECTION
POINTS DOWN FOR TIN PLATED TERMINALS
POINTS UP FOR PRECIOUS PLATED TERMINALS

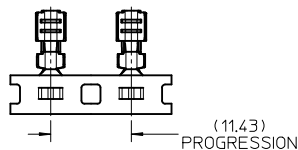

ENTER DESCRIPTION IEC NO: UAU2010-0419 DRAWN BY: DRWINKFERGUSON CHKD: A. DHIR APPR: B. MOSER 2009/12/02 2009/12/02	QUALITY SYMBOLS ▽=0 ▽=0	GENERAL TOLERANCES (UNLESS SPECIFIED)	DIMENSION STYLE MM ONLY	SCALE 3:1	DESIGN UNITS METRIC	THIRD ANGLE PROJECTION
	mm INCH	4 PLACES ± --- ± --- 3 PLACES ± --- ± --- 2 PLACES ± 0.10 ± --- 1 PLACE ± 0.3 ± --- ANGULAR ± 3 °	DRAWN BY DATE K. FERGUSON 4/14/2009 CHECKED BY DATE A. DHIR 4/14/2009 APPROVED BY DATE B. MOSER 4/14/2009	MX 150 RECEPTACLE CABLE SEAL		
A5	DRAFT WHERE APPLICABLE MUST REMAIN WITHIN DIMENSIONS	SEE TABLE	MATERIAL NO. DOCUMENT NO.	MOLEX INCORPORATED SD-34083-002		
		THIS DRAWING CONTAINS INFORMATION THAT IS PROPRIETARY TO MOLEX INCORPORATED AND SHOULD NOT BE USED WITHOUT WRITTEN PERMISSION			SHEET NO. 1 OF 3	

TABLE 1 – TERMINAL CRIMP DIMENSION REFERENCE TABLE

SUPPLIER PART NO.	PLATING	WIRE SIZE (awg)	WIRE SPECIFICATION	CONDUCTOR CCH (SEC Z-Z) ±0.05	CONDUCTOR CCW (SEC Z-Z) ±0.10	INSULATOR ICH (SEC Y-Y) ±0.10	INSULATOR ICW (SEC Y-Y) ±0.10	WIRE PULL FORCE (N)	OSR CABLE SEAL PART NO.	YAZAKI CABLE SEAL PART NO.	
RIGHT PAYOFF	LEFT PAYOFF										
34083-2001	34083-3001	TIN	14	MIL-123A	1.65	2.45	3.95	3.65	268	-	7158-3033-40
			14	MIL-135A1	1.65	2.45	3.80	3.65	268	E-1644-02	-
			16	MIL-123A	1.35	2.45	3.80	3.65	222	E-1644-02	-
34083-2002	34083-3002	TIN	18	MIL-123A	1.25	2.15	3.70	3.55	157	E-1644-00	-
			18	SAE J1128 (GXL)	1.25	2.15	3.90	3.55	157	E-1644-02	-
			20	MIL-123A	1.15	2.15	3.60	3.55	128	E-1644-00	-
			20	SAE J1128 (GXL)	1.15	2.15	3.80	3.55	128	E-1644-02	-
34083-2003	34083-3003	TIN	22	MIL-123A	1.00	1.60	3.50	3.45	88	E-1644-01	-
34083-2001	34083-3001	TIN	2.00mm ²	JASO D 611(AVSS)	1.60	2.45	3.95	3.65	268	-	7158-3033-40
34083-2001	34083-3001	TIN	1.50mm ²	MIL-126A1	1.40	2.45	3.80	3.65	257	E-1644-02	-
34083-2002	34083-3002	TIN	1.0mm ²	MIL-126A1	1.30	2.15	3.70	3.55	211	E-1644-00	-
34083-2002	34083-3002	TIN	0.75mm ²	MIL-126A1	1.25	2.15	3.60	3.55	142	E-1644-00	-
34083-2003	34083-3003	TIN	0.50mm ²	MIL-126A1	1.10	1.60	3.50	3.45	111	E-1644-01	-
34083-2003	34083-3003	TIN	0.50mm ²	JASO D 611(AVSS)	1.10	1.60	3.50	3.45	111	E-1644-01	-
34081-2003	34081-3003	GOLD	14	MIL-123A	1.65	2.45	3.95	3.65	268	-	7158-3033-40
			14	MIL-135A1	1.65	2.45	3.80	3.65	268	E-1644-02	-
			16	MIL-123A	1.35	2.45	3.80	3.65	222	E-1644-02	-
34081-2004	34081-3004	GOLD	18	MIL-123A	1.25	2.15	3.70	3.55	157	E-1644-00	-
			18	SAE J1128 (GXL)	1.25	2.15	3.90	3.55	157	E-1644-02	-
			20	MIL-123A	1.15	2.15	3.60	3.55	128	E-1644-00	-
			20	SAE J1128 (GXL)	1.15	2.15	3.80	3.55	128	E-1644-02	-
34081-2005	34081-3005	GOLD	22	MIL-123A	1.00	1.60	3.50	3.45	88	E-1644-01	-
34081-2003	34081-3003	GOLD	2.00mm ²	JASO D 611(AVSS)	1.60	2.45	3.95	3.65	268	-	7158-3033-40
34081-2003	34081-3003	GOLD	1.50mm ²	MIL-126A1	1.40	2.45	3.80	3.65	257	E-1644-02	-
34081-2004	34081-3004	GOLD	1.0mm ²	MIL-126A1	1.30	2.15	3.70	3.55	211	E-1644-00	-
			0.75mm ²	MIL-126A1	1.25	2.15	3.60	3.55	142	E-1644-00	-
			0.50mm ²	MIL-126A1	1.10	1.60	3.50	3.45	111	E-1644-01	-
34081-2005	34081-3005	GOLD	0.50mm ²	JASO D 611(AVSS)	1.10	1.60	3.50	3.45	111	E-1644-01	-
34081-4001	34081-5001	SILVER	14	MIL-123A	1.65	2.45	3.95	3.65	268	-	7158-3033-40
			14	MIL-135A1	1.65	2.45	3.80	3.65	268	E-1644-02	-
			16	MIL-123A	1.35	2.45	3.80	3.65	222	E-1644-02	-
34081-4002	34081-5002	SILVER	18	MIL-123A	1.25	2.15	3.70	3.55	157	E-1644-00	-
			18	SAE J1128 (GXL)	1.25	2.15	3.90	3.55	157	E-1644-02	-
			20	MIL-123A	1.15	2.15	3.60	3.55	128	E-1644-00	-
			20	SAE J1128 (GXL)	1.15	2.15	3.80	3.55	128	E-1644-02	-
34081-4003	34081-5003	SILVER	22	MIL-123A	1.00	1.60	3.50	3.45	88	E-1644-01	-
34081-4001	34081-5001	SILVER	2.00mm ²	JASO D 611(AVSS)	1.60	2.45	3.95	3.65	268	-	7158-3033-40
34081-4001	34081-5001	SILVER	1.50mm ²	MIL-126A1	1.40	2.45	3.80	3.65	257	E-1644-02	-
34081-4002	34081-5002	SILVER	1.0mm ²	MIL-126A1	1.30	2.15	3.70	3.55	211	E-1644-00	-
			0.75mm ²	MIL-126A1	1.25	2.15	3.60	3.55	142	E-1644-00	-
			0.50mm ²	MIL-126A1	1.10	1.60	3.50	3.45	111	E-1644-01	-
34081-4003	34081-5003	SILVER	0.50mm ²	JASO D 611(AVSS)	1.10	1.60	3.50	3.45	111	E-1644-01	-

ENTER DESCRIPTION IEC NO. UAU2010-0419 DRAWN BY K. FERGUSON CHECKED BY CHIKKA, DHIR APPR. BY MOSER DATE 2009/12/02 REV DESCRIPTION 2009/12/02	QUALITY SYMBOLS ▽=0 ▽=0		GENERAL TOLERANCES (UNLESS SPECIFIED) DIM INCH 4 PLACES ± .005 3 PLACES ± .003 2 PLACES ± 0.10 1 PLACE ± 0.3 ANGULAR ± 3°		DIMENSION STYLE MM ONLY		SCALE METRIC	DESIGN UNITS METRIC	THIRD ANGLE PROJECTION	
	DRAFT WHERE APPLICABLE MUST REMAIN WITHIN DIMENSIONS		DRAWN BY DATE K. FERGUSON 4/14/2009		CHECKED BY DATE A. DHIR 4/14/2009		TITLE MX 150 RECEPTACLE CABLE SEAL			
	MATERIAL NO. SEE TABLE		APPROVED BY DATE B. MOSER 4/14/2009		MOLEX INCORPORATED			DOCUMENT NO. SD-34083-002		
	SIZE D		THIS DRAWING CONTAINS INFORMATION THAT IS PROPRIETARY TO MOLEX INCORPORATED AND SHOULD NOT BE USED WITHOUT WRITTEN PERMISSION		SHEET NO. 2 OF 3					

CRIMP TOOL INFORMATION
SEE TABLE 2 FOR TABLED DIMENSIONS

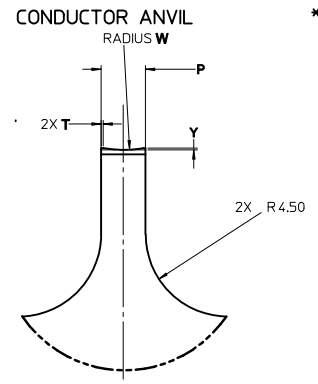
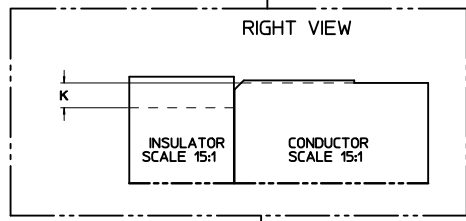
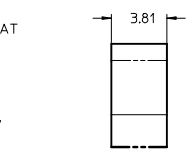
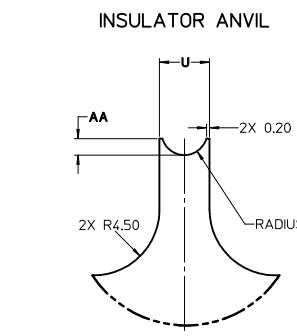
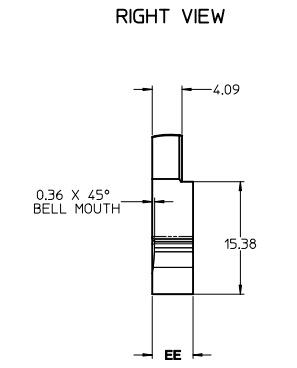
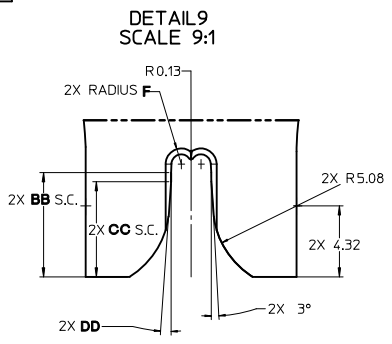
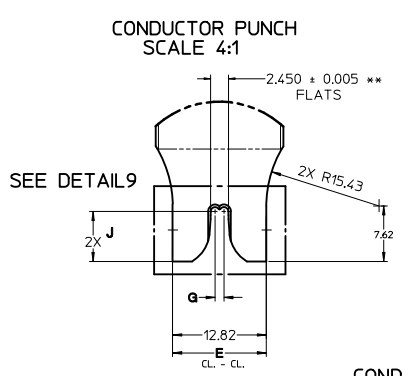
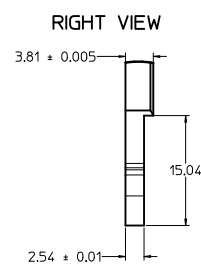
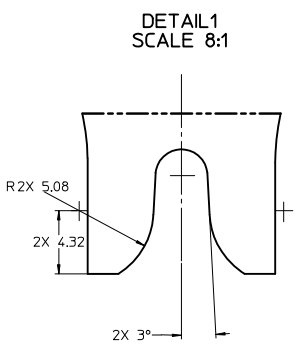
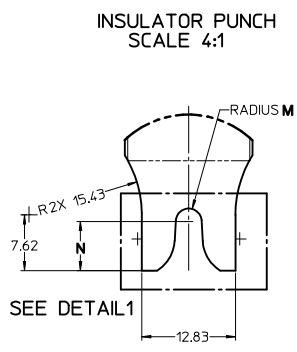

** 14-16 AWG, 150mm² & 2.0mm² ONLY

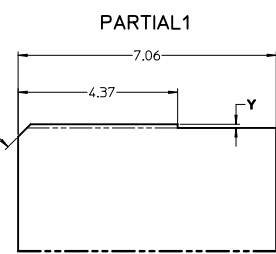

TABLE 2 - TERMINAL GRIP/CRIMP TOOL DIMENSION REFERENCE TABLE

SUPPLIER PART NUMBER		PLATING (STAMPING)	WIRE APPLICATION		A	B	C	D	E	F	G	J	K	M	N	P	T	U	V	W	Y	AA	BB	CC	DD	EE
RIGHT PAYOFF	LEFT PAYOFF		SAE (AWG)	METRIC (mm ²)	+0.3	+0.20	+0.3	+0.15	+0.01	+0.005	+0.005	+0.05	+0.01	+0.005	+0.10	+0.005	+0.03	+0.005	+0.005	+0.10	+0.01	+0.10	+0.01	+0.01	+0.01	±P
34083-2001	34083-3001	TIN	14	2.0	3.6	5.00	1.7	2.90	12.82	0.600	1.194	6.86	0.90	1.778	6.73	2.438	0.12	3.429	1.575	6.11	0.10	1.13	6.34	5.79	4°	5.59
			16	1.5	3.6	5.00	1.7	2.90	12.82	0.600	1.194	6.86	0.90	1.778	6.73	2.438	0.12	3.429	1.575	6.11	0.10	1.13	6.34	5.79	4°	5.59
34083-2002	34083-3002	TIN	18	1.0	3.3	5.00	1.3	2.90	12.57	0.556	0.963	7.34	0.70	1.753	6.73	2.085	0.33	3.378	1.699	1.94	0.14	0.88	-	-	-	3.81
			20	0.75	3.3	5.00	1.3	2.90	12.57	0.556	0.963	7.34	0.70	1.753	6.73	2.085	0.33	3.378	1.699	1.94	0.14	0.88	-	-	-	3.81
34083-2003	34083-3003	TIN	22	0.5	2.5	4.85	0.9	2.90	11.92	0.414	0.714	6.27	0.55	1.737	7.06	1.576	0.26	3.327	1.524	2.00	0.07	1.08	-	-	-	3.81
34081-2003	34081-3003	GOLD	14	2.0	3.6	5.00	1.7	2.90	12.82	0.600	1.194	6.86	0.90	1.778	6.73	2.438	0.12	3.429	1.575	6.11	0.10	1.13	6.34	5.79	4°	5.59
			16	1.5	3.6	5.00	1.7	2.90	12.82	0.600	1.194	6.86	0.90	1.778	6.73	2.438	0.12	3.429	1.575	6.11	0.10	1.13	6.34	5.79	4°	5.59
34081-2004	34081-3004	GOLD	18	1.0	3.3	5.00	1.3	2.90	12.57	0.556	0.963	7.34	0.70	1.753	6.73	2.085	0.33	3.378	1.699	1.94	0.14	0.88	-	-	-	3.81
			20	0.75	3.3	5.00	1.3	2.90	12.57	0.556	0.963	7.34	0.70	1.753	6.73	2.085	0.33	3.378	1.699	1.94	0.14	0.88	-	-	-	3.81
34081-2005	34081-3005	GOLD	22	0.5	2.5	4.85	0.9	2.90	11.92	0.414	0.714	6.27	0.55	1.737	7.06	1.576	0.26	3.327	1.524	2.00	0.07	1.08	-	-	-	3.81
			14	2.0	3.6	5.00	1.7	2.90	12.82	0.600	1.194	6.86	0.90	1.778	6.73	2.438	0.12	3.429	1.575	6.11	0.10	1.13	6.34	5.79	4°	5.59
34081-4001	34081-5001	SILVER	16	1.5	3.6	5.00	1.7	2.90	12.82	0.600	1.194	6.86	0.90	1.778	6.73	2.438	0.12	3.429	1.575	6.11	0.10	1.13	6.34	5.79	4°	5.59
			18	1.0	3.3	5.00	1.3	2.90	12.57	0.556	0.963	7.34	0.70	1.753	6.73	2.085	0.33	3.378	1.699	1.94	0.14	0.88	-	-	-	3.81
34081-4002	34081-5002	SILVER	20	0.75	3.3	5.00	1.3	2.90	12.57	0.556	0.963	7.34	0.70	1.753	6.73	2.085	0.33	3.378	1.699	1.94	0.14	0.88	-	-	-	3.81
			22	0.5	2.5	4.85	0.9	2.90	11.92	0.414	0.714	6.27	0.55	1.737	7.06	1.576	0.26	3.327	1.524	2.00	0.07	1.08	-	-	-	3.81

ENTER DESCRIPTION EC NO. 141/2010-04-9 DR. DWAN FERGUSON 2009/12/02 CHK'D BY A. DHIR 2009/04/15 APPR'D BY B. MOSELER 2009/04/15 A5	QUALITY SYMBOLS 0 1	GENERAL TOLERANCES (UNLESS SPECIFIED) mm INCH 4 PLACES ± --- ± --- 3 PLACES ± --- ± --- 2 PLACES ± 0.10 ± --- 1 PLACE ± 0.3 ± --- ANGULAR ± 3°	DIMENSION STYLE MM ONLY SCALE 1:1 DESIGN UNITS METRIC THIRD ANGLE PROJECTION	
	DRAWN BY K. FERGUSON 4/14/2009 CHECKED BY DATE 4/14/2009 A. DHIR 4/14/2009 APPROVED BY DATE 4/14/2009 B. MOSELER	TITLE MX 150 RECEPTACLE CABLE SEAL	MATERIAL NO. SEE TABLE DOCUMENT NO. SD-34083-002	SHEET NO. 3 OF 3
	DRAFT WHERE APPLICABLE MUST REMAIN WITHIN DIMENSIONS			THIS DRAWING CONTAINS INFORMATION THAT IS PROPRIETARY TO MOLEX INCORPORATED AND SHOULD NOT BE USED WITHOUT WRITTEN PERMISSION
	MOLEX INCORPORATED			MOLEX INCORPORATED
	2009/12/02 2009/04/15			1

Данный компонент на территории Российской Федерации

Вы можете приобрести в компании MosChip.

Для оперативного оформления запроса Вам необходимо перейти по данной ссылке:

<http://moschip.ru/get-element>

Вы можете разместить у нас заказ для любого Вашего проекта, будь то серийное производство или разработка единичного прибора.

В нашем ассортименте представлены ведущие мировые производители активных и пассивных электронных компонентов.

Нашей специализацией является поставка электронной компонентной базы двойного назначения, продукции таких производителей как XILINX, Intel (ex.ALTERA), Vicor, Microchip, Texas Instruments, Analog Devices, Mini-Circuits, Amphenol, Glenair.

Сотрудничество с глобальными дистрибьюторами электронных компонентов, предоставляет возможность заказывать и получать с международных складов практически любой перечень компонентов в оптимальные для Вас сроки.

На всех этапах разработки и производства наши партнеры могут получить квалифицированную поддержку опытных инженеров.

Система менеджмента качества компании отвечает требованиям в соответствии с ГОСТ Р ИСО 9001, ГОСТ РВ 0015-002 и ЭС РД 009

Офис по работе с юридическими лицами:

105318, г.Москва, ул.Щербаковская д.3, офис 1107, 1118, ДЦ «Щербаковский»

Телефон: +7 495 668-12-70 (многоканальный)

Факс: +7 495 668-12-70 (доб.304)

E-mail: info@moschip.ru

Skype отдела продаж:

moschip.ru

moschip.ru_4

moschip.ru_6

moschip.ru_9