

3M™ HIGH ROUTABILITY INTERNAL SATA CABLE ASSEMBLY

REVISION RECORD		
REV.	ECR/ECN/ECO NUMBER	DATE
A	ECO-0037492	05/09/11
B	ECO-0042030	13/07/12
C	ECO-0043801, CABLE P/N CHG	31/12/12



- NOTES :
- Regulatory Information.
RoHs compliant, See the regulatory information appendix(RIA) in the "RoHs compliance" section of WWW.3Mconnectors.com compliance information (RIA E1 & C1 apply)
 - For custom cable length, contact 3M sales rep.
 - Cable part number : SL8803/04-10DN5-00
 - Product Specification: PS-0117.
 - This cable construction has a thin aluminum layer at each edge. User should evaluate its use in their application and, if necessary, insulating tape may be applied to cover the aluminum layer, as User deems appropriate
 - PVC overmoulding and PE Inner moulding at both ends.
 - Product meets SATA 3.0 signal integrity specifications.

PART NUMBER SELECTION

5602-11-0142A-XXX
Length in mm,000 refers to 1000mm.

3M PART NO.	L(MM)
5602-11-0142A-100	100
5602-11-0142A-200	200
5602-11-0142A-300	300
5602-11-0142A-400	400
5602-11-0142A-500	500
5602-11-0142A-600	600
5602-11-0142A-700	700
5602-11-0142A-800	800
5602-11-0142A-900	900
5602-11-0142A-000	1000

PIN OUT				
P1	TYPE	TYPE	P2	
1	G	G	1	
2	A+	A+	2	
3	A-	A-	3	
4	G	G	4	
5	B-	B-	5	
6	B+	B+	6	
7	G	G	7	

ITEM	SPECIFICATION	Q'TY	UNIT
3	CABLE : RIBBON TWIN AX , SL8803/04, UL AWM 21008,150V,80C SIGNAL -SILVER PLATED COPPER WITH 30 AWG.	1	PC
2	SATA CONN : 7P FEMALE 90° BLACK PBT30% 15*AU	1	PC
1	SATA CONN : 7P FEMALE 90° BLACK PBT30% 15*AU	1	PC

UNIT: MM	DFTG RAD VITTAPALLI	DATE 13/07/12	3M APAC INNOVATION CENTRE	DIVISION	ESD	STATUS
GEN. TOLERANCES	CHKD RAD VITTAPALLI	DATE 13/07/12		MODEL		RELEASE
LINEAR .0 = ± 0.25 .00 = ± 0.15 .000 = ± 0.05	APPVL ALAN ANG	DATE 13/07/12	TITLE SATA 7 PIN RIBBON TWINAX CABLE ASSEMBLY RIGHT ANGLE TO RIGHT ANGLE W/O LATCH			
ANGLE ±1°	THIS DOCUMENT CONTAINS INFORMATION WHICH IS PROPRIETARY TO 3M COMPANY. NO REPRODUCTION OR PUBLICATION OF THIS DOCUMENT, IN WHOLE OR IN PART, SHALL BE MADE WITHOUT AUTHORIZATION FROM 3M. © 3M 2013. ALL RIGHTS RESERVED.		SIZE A3	DRAWING NO. 78-5100-4897-8	REV C	
PROJECTION	INTERPRET PER ASME Y14.5M-1994		SCALE : NTS	DET LIST	<input type="checkbox"/> YES <input type="checkbox"/> NO	SHT 1 of 7
	CRITICAL DIMENSION: ▲					

3M™ HIGH ROUTABILITY INTERNAL SATA CABLE ASSEMBLY

REVISION RECORD		
REV.	ECR/ECN/ECO NUMBER	DATE
REFER TO SHT 1 OF 7		

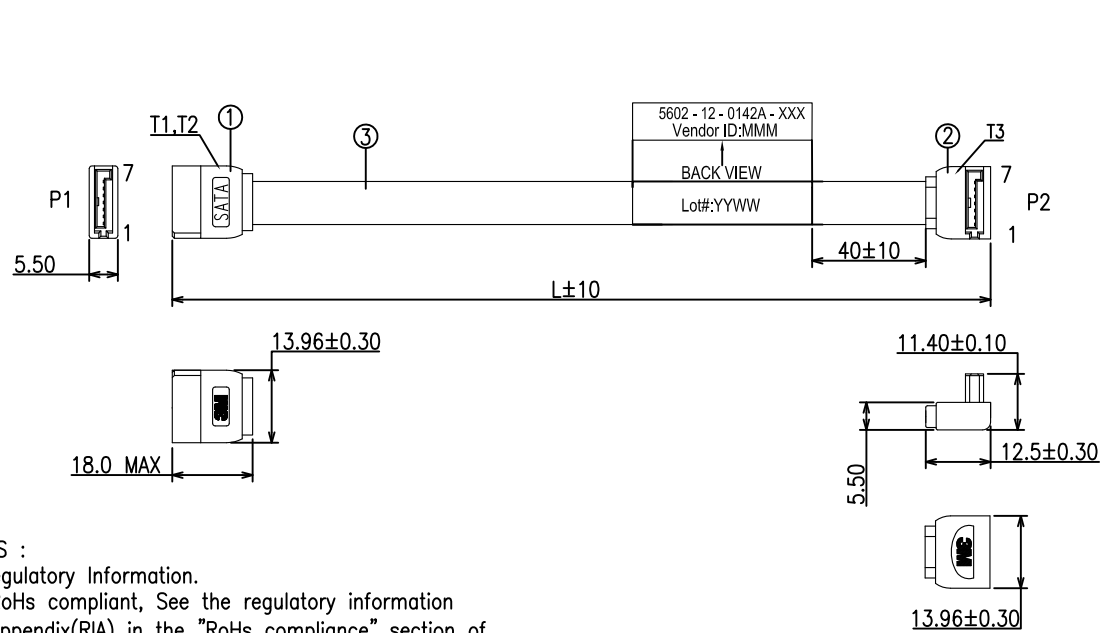

NOTES :

- Regulatory Information.
RoHs compliant, See the regulatory information appendix(RIA) in the "RoHs compliance" section of WWW.3Mconnectors.com compliance information (RIA E1 & C1 apply)
- For custom cable length, contact 3M sales rep.
- Cable Part number: SL8803/04-10DN5-00
- Product Specification: PS-0117.
- This cable construction has a thin aluminum layer at each edge.
User should evaluate its use in their application and, if necessary, insulating tape may be applied to cover the aluminum layer, as User deems appropriate
- PVC overmoulding and PE Inner moulding at both ends.
- Product meets SATA 3.0 signal integrity specifications.

PART NUMBER SELECTION

5602-12-0142A-XXX
Length in mm,000 refers to 1000mm.

3M PART NO.	L(MM)
5602-12-0142A-100	100
5602-12-0142A-200	200
5602-12-0142A-300	300
5602-12-0142A-400	400
5602-12-0142A-500	500
5602-12-0142A-600	600
5602-12-0142A-700	700
5602-12-0142A-800	800
5602-12-0142A-900	900
5602-12-0142A-000	1000

PIN OUT			
P1	TYPE	TYPE	P2
1	G	G	1
2	A+	A+	2
3	A-	A-	3
4	G	G	4
5	B-	B-	5
6	B+	B+	6
7	G	G	7

ITEM	SPECIFICATION	Q'TY	UNIT
3	CABLE : RIBBON TWIN AX , SL8803/04, UL AWM 21008,150V,80C SIGNAL -SILVER PLATED COPPER CONDUCTOR 30 AWG.	1	PC
2	SATA CONN : 7P FEMALE 90° BLACK PBT 30%GF 15*AU	1	PC
1	SATA CONN : 7P FEMALE 180° BLACK PBT 30%GF 15*AU	1	PC

UNIT: MM	DFTG RAD VITTAPALLI	DATE 13/07/12	3M APAC INNOVATION CENTRE	DIVISION	ESD	STATUS
GEN. TOLERANCES	CHKD RAD VITTAPALLI	DATE 13/07/12		MODEL		RELEASE
LINEAR .0 = ± 0.25 .00 = ± 0.15 .000 = ± 0.05	APPVL ALAN ANG	DATE 13/07/12	TITLE SATA 7 PIN RIBBON TWINAX CABLE ASSEMBLY STRAIGHT TO RIGHT ANGLE W/O LATCH			
ANGLE ±1°	THIS DOCUMENT CONTAINS INFORMATION WHICH IS PROPRIETARY TO 3M COMPANY. NO REPRODUCTION OR PUBLICATION OF THIS DOCUMENT, IN WHOLE OR IN PART, SHALL BE MADE WITHOUT AUTHORIZATION FROM 3M. © 3M 2013. ALL RIGHTS RESERVED.		SIZE A3	DRAWING NO. 78-5100-4897-8	REV C	
PROJECTION	INTERPRET PER ASME Y14.5M-1994	SCALE : NTS		DET LIST	<input type="checkbox"/> YES <input type="checkbox"/> NO	SHT 2 of 7
CRITICAL DIMENSION: ▲						

3M™ HIGH ROUTABILITY INTERNAL SATA CABLE ASSEMBLY

REVISION RECORD		
REV.	ECR/ECN/ECO NUMBER	DATE
REFER TO SHT 1 OF 7		



Vendor ID: MMM
 Lot control date: YYWW
 Part No: 5602-21-0142A-XXX

NOTES :

- Regulatory Information.
 RoHs compliant, See the regulatory information appendix(RIA) in the "RoHs compliance" section of WWW.3Mconnectors.com compliance information (RIA E1 & C1 apply)
- For custom cable length, contact 3M sales rep.
- Cable Part number : SL8803/04-10DN5-00
- Product Specification: PS-0117.
- This cable construction has a thin aluminum layer at each edge.
 User should evaluate its use in their application and, if necessary, insulating tape may be applied to cover the aluminum layer, as User deems appropriate
- PVC overmoulding and PE Inner moulding at both ends.
- Product meets SATA 3.0 signal integrity specifications.

PART NUMBER SELECTION

5602-21-0142A-XXX
 Length in mm,000 refers to 1000mm.

3M PART NO.	L(MM)
5602-21-0142A-100	100
5602-21-0142A-200	200
5602-21-0142A-300	300
5602-21-0142A-400	400
5602-21-0142A-500	500
5602-21-0142A-600	600
5602-21-0142A-700	700
5602-21-0142A-800	800
5602-21-0142A-900	900
5602-21-0142A-000	1000

PIN OUT

P1	TYPE	TYPE	P2
1	G	G	1
2	A+	A+	2
3	A-	A-	3
4	G	G	4
5	B-	B-	5
6	B+	B+	6
7	G	G	7

ITEM	SPECIFICATION	Q'TY	UNIT
3	CABLE : RIBBON TWIN AX , SL8803/04, UL AWM 21008,150V,80C SIGNAL -SILVER PLATED COPPER CONDUCTOR 30 AWG.	1	PC
2	SATA CONN : 7P FEMALE 90° BLACK PBT 30%GF 15*AU	1	PC
1	SATA CONN : 7P FEMALE 180° BLACK PBT 30%GF 15*AU	1	PC

UNIT: MM	DFTG RAD VITTAPALLI	DATE 13/07/12	3M APAC INNOVATION CENTRE	DIVISION	ESD	STATUS
GEN. TOLERANCES	CHKD RAD VITTAPALLI	DATE 13/07/12		MODEL		RELEASE
LINEAR .0 = ± 0.25 .00 = ± 0.15 .000 = ± 0.05	APPVL ALAN ANG	DATE 13/07/12	TITLE SATA 7 PIN RIBBON TWINAX CABLE ASSEMBLY STRAIGHT TO RIGHT ANGLE W/O LATCH			
ANGLE ±1°	THIS DOCUMENT CONTAINS INFORMATION WHICH IS PROPRIETARY TO 3M COMPANY. NO REPRODUCTION OR PUBLICATION OF THIS DOCUMENT, IN WHOLE OR IN PART, SHALL BE MADE WITHOUT AUTHORIZATION FROM 3M. © 3M 2013. ALL RIGHTS RESERVED.		SIZE A3	DRAWING NO. 78-5100-4897-8	REV C	
PROJECTION	INTERPRET PER ASME Y14.5M-1994	SCALE : NTS		DET LIST	<input type="checkbox"/> YES <input type="checkbox"/> NO	SHT 3 of 7
CRITICAL DIMENSION: ▲						

3M™ HIGH ROUTABILITY INTERNAL SATA CABLE ASSEMBLY

REVISION RECORD		
REV.	ECR/ECN/ECO NUMBER	DATE
REFER TO SHT 1 OF 7		



NOTES :

- Regulatory Information.
RoHs compliant, See the regulatory information appendix(RIA) in the "RoHs compliance" section of WWW.3Mconnectors.com compliance information (RIA E1 & C1 apply)
- For custom cable length, contact 3M sales rep.
- Cable Part number: SL8803/04-10DN5-00
- Product Specification: PS-0117.
- This cable construction has a thin aluminum layer at each edge. User should evaluate its use in their application and, if necessary, insulating tape may be applied to cover the aluminum layer, as User deems appropriate
- PVC overmoulding and PE Inner moulding at both ends.
- Product meets SATA 3.0 signal integrity specifications.

PART NUMBER SELECTION

5602-22-0142A-XXX
Length in mm,000 refers to 1000mm.

3M PART NO.	L(MM)
5602-22-0142A-100	100
5602-22-0142A-200	200
5602-22-0142A-300	300
5602-22-0142A-400	400
5602-22-0142A-500	500
5602-22-0142A-600	600
5602-22-0142A-700	700
5602-22-0142A-800	800
5602-22-0142A-900	900
5602-22-0142A-000	1000

PIN OUT			
P1	TYPE	TYPE	P2
1	G	G	1
2	A+	A+	2
3	A-	A-	3
4	G	G	4
5	B-	B-	5
6	B+	B+	6
7	G	G	7

ITEM	SPECIFICATION	Q'TY	UNIT
2	CABLE : RIBBON TWIN AX , SL8803/04, UL AWM 21008,150V,80C	1	PC
	SIGNAL -SILVER PLATED COPPER CONDUCTOR WITH 30 AWG.		
1	SATA CONN : 7P FEMALE 180° BLACK PBT 30GF , 15"AU	2	PCS

UNIT: MM	DFTG RAD VITTAPALLI	DATE 13/07/12	3M APAC INNOVATION CENTRE	DIVISION	ESD	STATUS
GEN. TOLERANCES	CHKD RAD VITTAPALLI	DATE 13/07/12		MODEL		RELEASE
LINEAR .0 = ± 0.25 .00 = ± 0.15 .000 = ± 0.05	APPVL ALAN ANG	DATE 13/07/12	TITLE SATA 7 PIN RIBBON TWINAX CABLE ASSEMBLY STRAIGHT TO STRAIGHT W/O LATCH			
ANGLE ±1°	THIS DOCUMENT CONTAINS INFORMATION WHICH IS PROPRIETARY TO 3M COMPANY. NO REPRODUCTION OR PUBLICATION OF THIS DOCUMENT, IN WHOLE OR IN PART, SHALL BE MADE WITHOUT AUTHORIZATION FROM 3M. © 3M 2013. ALL RIGHTS RESERVED.		SIZE A3	DRAWING NO. 78-5100-4897-8	REV C	
PROJECTION	INTERPRET PER ASME Y14.5M-1994		SCALE : NTS	DET LIST	<input type="checkbox"/> YES <input type="checkbox"/> NO	SHT 4 of 7
	CRITICAL DIMENSION: ▲					

3M™ HIGH ROUTABILITY INTERNAL SATA CABLE ASSEMBLY

REVISION RECORD		
REV.	ECR/ECN/ECO NUMBER	DATE
REFER TO SHIT 1 OF 7		

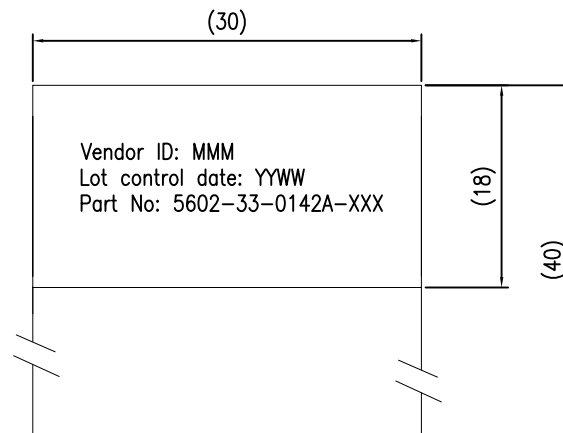
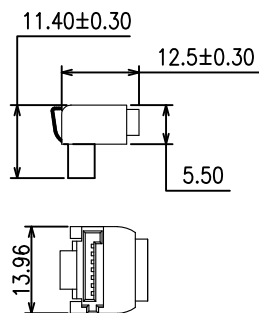
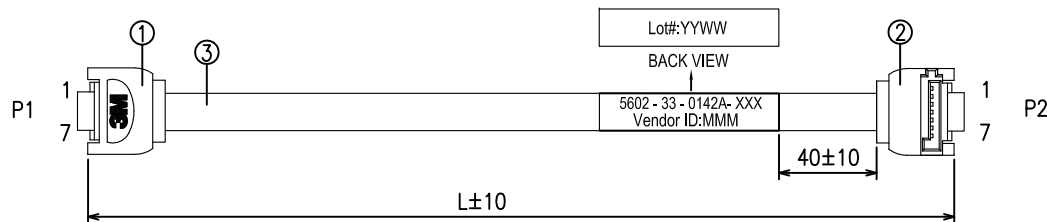

NOTES :

- Regulatory Information.
RoHs compliant, See the regulatory information appendix(RIA) in the "RoHs compliance" section of WWW.3Mconnectors.com compliance information (RIA E1 & C1 apply)
- For custom cable length, contact 3M sales rep.
- Cable part number: SL8803/04-10DN5-00
- Product Specification: PS-0117.
- This cable construction has a thin aluminum layer at each edge. User should evaluate its use in their application and, if necessary, insulating tape may be applied to cover the aluminum layer, as User deems appropriate
- PVC overmoulding and PE Inner moulding at both ends.
- Product meets SATA 3.0 signal integrity specifications.

PART NUMBER SELECTION

5602-33-0142A-XXX
Length in mm,000 refers to 1000mm.

3M PART NO.	L(MM)
5602-33-0142A-100	100
5602-33-0142A-200	200
5602-33-0142A-300	300
5602-33-0142A-400	400
5602-33-0142A-500	500
5602-33-0142A-600	600
5602-33-0142A-700	700
5602-33-0142A-800	800
5602-33-0142A-900	900
5602-33-0142A-000	1000

PIN OUT

P1	TYPE	TYPE	P2
1	G	G	1
2	A+	A+	2
3	A-	A-	3
4	G	G	4
5	B-	B-	5
6	B+	B+	6
7	G	G	7

ITEM	SPECIFICATION	Q'TY	UNIT
3	CABLE : RIBBON TWIN AX , SL8803/04, UL AWM 21008,150V,80C SIGNAL -SILVER PLATED COPPER WITH 30 AWG.	1	PC
2	SATA CONN : 7P FEMALE 90° BLACK PBT30% 15*AU WITH LATCH	1	PC
1	SATA CONN : 7P FEMALE 90° BLACK PBT30% 15*AU WITH LATCH	1	PC

UNIT: MM	DFTG RAD VITTAPALLI	DATE 13/07/12	3M APAC INNOVATION CENTRE	DIVISION ESD	STATUS RELEASE
GEN. TOLERANCES	CHKD RAD VITTAPALLI	DATE 13/07/12		MODEL	
LINEAR .0 = ± 0.25 .00 = ± 0.15 .000 = ± 0.05	APPVL ALAN ANG	DATE 13/07/12	TITLE SATA 7 PIN RIBBON TWINAX CABLE ASSEMBLY RIGHT ANGLE TO RIGHT ANGLE WITH LATCH		
ANGLE ±1°	THIS DOCUMENT CONTAINS INFORMATION WHICH IS PROPRIETARY TO 3M COMPANY. NO REPRODUCTION OR PUBLICATION OF THIS DOCUMENT, IN WHOLE OR IN PART, SHALL BE MADE WITHOUT AUTHORIZATION FROM 3M. © 3M 2013. ALL RIGHTS RESERVED.		SIZE A3	DRAWING NO. 78-5100-4897-8	REV C
PROJECTION	INTERPRET PER ASME Y14.5M-1994		SCALE : NTS	DET LIST <input type="checkbox"/> YES <input type="checkbox"/> NO	SHT 5 of 7
	CRITICAL DIMENSION: ▲				

WWW.3Mconnectors.com

3M™ HIGH ROUTABILITY INTERNAL SATA CABLE ASSEMBLY

REVISION RECORD		
REV.	ECR/ECN/ECO NUMBER	DATE
REFER TO SHT 1 OF 7		



NOTES :

- Regulatory Information.
RoHs compliant, See the regulatory information appendix(RIA) in the "RoHs compliance" section of WWW.3Mconnectors.com compliance information (RIA E1 & C1 apply)
- For custom cable length, contact 3M sales rep.
- Cable Part number: SL8803/04-10DN5-00
- Product Specification: PS-0117.
- This cable construction has a thin aluminum layer at each edge. User should evaluate its use in their application and, if necessary, insulating tape may be applied to cover the aluminum layer, as User deems appropriate
- PVC overmoulding and PE Inner moulding at both ends.
- Product meets SATA 3.0 signal integrity specifications.

PART NUMBER SELECTION

5602-34-0142A-XXX
Length in mm,000 refers to 1000mm.

3M PART NO.	L(MM)
5602-34-0142A-100	100
5602-34-0142A-200	200
5602-34-0142A-300	300
5602-34-0142A-400	400
5602-34-0142A-500	500
5602-34-0142A-600	600
5602-34-0142A-700	700
5602-34-0142A-800	800
5602-34-0142A-900	900
5602-34-0142A-000	1000

PIN OUT			
P1	TYPE	TYPE	P2
1	G	G	1
2	A+	A+	2
3	A-	A-	3
4	G	G	4
5	B-	B-	5
6	B+	B+	6
7	G	G	7

ITEM	SPECIFICATION	Q'TY	UNIT
3	CABLE : RIBBON TWIN AX , SL8803/04, UL AWM 21008,150V,80C SIGNAL -SILVER PLATED COPPER CONDUCTOR 30 AWG.	1	PC
2	SATA CONN : 7P FEMALE 90° BLACK PBT 30%GF 15*AU WITH LATCH	1	PC
1	SATA CONN : 7P FEMALE 180° BLACK PBT 30%GF 15*AU WITH LATCH	1	PC

UNIT: MM	DFTG RAD VITTAPALLI	DATE 13/07/12	3M APAC INNOVATION CENTRE	DIVISION	ESD	STATUS
GEN. TOLERANCES	CHKD RAD VITTAPALLI	DATE 13/07/12		MODEL		RELEASE
LINEAR .0 = ± 0.25 .00 = ± 0.15 .000 = ± 0.05	APPVL ALAN ANG	DATE 13/07/12	TITLE SATA 7 PIN RIBBON TWINAX CABLE ASSEMBLY STRAIGHT TO RIGHT ANGLE WITH LATCH			
ANGLE ±1°	THIS DOCUMENT CONTAINS INFORMATION WHICH IS PROPRIETARY TO 3M COMPANY. NO REPRODUCTION OR PUBLICATION OF THIS DOCUMENT, IN WHOLE OR IN PART, SHALL BE MADE WITHOUT AUTHORIZATION FROM 3M. © 3M 2013. ALL RIGHTS RESERVED.		SIZE A3	DRAWING NO. 78-5100-4897-8	REV C	
PROJECTION	INTERPRET PER ASME Y14.5M-1994	SCALE : NTS		DET LIST	<input type="checkbox"/> YES <input type="checkbox"/> NO	SHT 6 of 7
CRITICAL DIMENSION: ▲						

WWW.3Mconnectors.com

3M™ HIGH ROUTABILITY INTERNAL SATA CABLE ASSEMBLY

REVISION RECORD		
REV.	ECR/ECN/ECO NUMBER	DATE
REFER TO SHT 1 OF 7		



NOTES :

- Regulatory Information.
RoHs compliant, See the regulatory information appendix(RIA) in the "RoHs compliance" section of WWW.3Mconnectors.com compliance information (RIA E1 & C1 apply)
- For custom cable length, contact 3M sales rep.
- Cable Part number: SL8803/04-10DN5-00
- Product Specification: PS-0117.
- This cable construction has a thin aluminum layer at each edge. User should evaluate its use in their application and, if necessary, insulating tape may be applied to cover the aluminum layer, as User deems appropriate
- PVC overmoulding and PE Inner moulding at both ends.
- Product meets SATA 3.0 signal integrity specifications.

PART NUMBER SELECTION

5602-44-0142A-XXX
Length in mm,000 refers to 1000mm.

3M PART NO.	L(MM)
5602-44-0142A-100	100
5602-44-0142A-200	200
5602-44-0142A-300	300
5602-44-0142A-400	400
5602-44-0142A-500	500
5602-44-0142A-600	600
5602-44-0142A-700	700
5602-44-0142A-800	800
5602-44-0142A-900	900
5602-44-0142A-000	1000

PIN OUT			
P1	TYPE	TYPE	P2
1	G	G	1
2	A+	A+	2
3	A-	A-	3
4	G	G	4
5	B-	B-	5
6	B+	B+	6
7	G	G	7

ITEM	SPECIFICATION	Q'TY	UNIT
2	CABLE : RIBBON TWIN AX , SL8803/04, UL AWM 21008,150V,80C	1	PC
	SIGNAL -SILVER PLATED COPPER CONDUCTOR WITH 30 AWG.		
1	SATA CONN : 7P FEMALE 180° BLACK PBT 30GF , 15°AU WITH LATCH	2	PCS

UNIT: MM	DFTG RAD VITTAPALLI	DATE 13/07/12		DIVISION ESD	STATUS
GEN. TOLERANCES	CHKD RAD VITTAPALLI	DATE 13/07/12		MODEL	RELEASE
LINEAR .0 = ± 0.25 .00 = ± 0.15 .000 = ± 0.05	APPVL ALAN ANG	DATE 13/07/12		TITLE SATA 7 PIN RIBBON TWINAX CABLE ASSEMBLY STRAIGHT TO STRAIGHT WITH LATCH	
ANGLE ±1°	THIS DOCUMENT CONTAINS INFORMATION WHICH IS PROPRIETARY TO 3M COMPANY. NO REPRODUCTION OR PUBLICATION OF THIS DOCUMENT, IN WHOLE OR IN PART, SHALL BE MADE WITHOUT AUTHORIZATION FROM 3M. © 3M 2013. ALL RIGHTS RESERVED.		SIZE A3	DRAWING NO. 78-5100-4897-8	REV C
PROJECTION	INTERPRET PER ASME Y14.5M-1994	SCALE : NTS		DET LIST <input type="checkbox"/> YES <input type="checkbox"/> NO	SHT 7 of 7

WWW.3Mconnectors.com

Данный компонент на территории Российской Федерации

Вы можете приобрести в компании MosChip.

Для оперативного оформления запроса Вам необходимо перейти по данной ссылке:

<http://moschip.ru/get-element>

Вы можете разместить у нас заказ для любого Вашего проекта, будь то серийное производство или разработка единичного прибора.

В нашем ассортименте представлены ведущие мировые производители активных и пассивных электронных компонентов.

Нашей специализацией является поставка электронной компонентной базы двойного назначения, продукции таких производителей как XILINX, Intel (ex.ALTERA), Vicor, Microchip, Texas Instruments, Analog Devices, Mini-Circuits, Amphenol, Glenair.

Сотрудничество с глобальными дистрибьюторами электронных компонентов, предоставляет возможность заказывать и получать с международных складов практически любой перечень компонентов в оптимальные для Вас сроки.

На всех этапах разработки и производства наши партнеры могут получить квалифицированную поддержку опытных инженеров.

Система менеджмента качества компании отвечает требованиям в соответствии с ГОСТ Р ИСО 9001, ГОСТ РВ 0015-002 и ЭС РД 009

Офис по работе с юридическими лицами:

105318, г.Москва, ул.Щербаковская д.3, офис 1107, 1118, ДЦ «Щербаковский»

Телефон: +7 495 668-12-70 (многоканальный)

Факс: +7 495 668-12-70 (доб.304)

E-mail: info@moschip.ru

Skype отдела продаж:

moschip.ru

moschip.ru_4

moschip.ru_6

moschip.ru_9