

# Features

- Replacement for R-78Axx-0.5SMD series
- RoHS 6/6 Conform (100% Lead Free)
- Efficiency up to 97%, Non isolated, no need for heatsinks
- High Reflow Temperature SMD Package
- Adjustable Output Voltage
- Wide input range.(4.75V ~ 32V)
- Short circuit protection, Thermal shutdown
- Remote On/Off Control
- UL94V-0 Package Material
- Very Low Shutdown Current
- See Ininline Application Notes for use as an inverter (alternative to LM79xx Linear)

## Description

The R-78Axx-0.5SMD series are manufactured without lead and meet the requirements for RoHS 6/6 as well as the increased reflow soldering temperatures associated with vapour phase soldering, making these high efficiency switching regulators ideally suited to modern pick-and-place mass production. The efficiency of up to 97% means that very little energy is wasted as heat. The additional features of remote on/off control and adjustable output voltages will find many uses in the battery-powered, industrial, medical and automotive markets.

## Selection Guide

Part Number SMD	Input Range (V)	Output Voltage (V)	Adjust Range (V)	Output Current (A)	Efficiency	
					Min. Vin (%)	Max. Vin (%)
R-78AA1.5-0.5SMD	4.75 – 30	1.5	fixed	0.5	73	63
R-78AA1.8-0.5SMD	4.75 – 32	1.8	1.5~3.0	0.5	82	71
R-78AA2.5-0.5SMD	4.75 – 32	2.5	1.5~3.0	0.5	87	77
R-78AA3.3-0.5SMD	4.75 – 32	3.3	3.0~5.5	0.5	91	81
R-78AA5.0-0.5SMD	6.5 – 32	5.0	3.0~8.0	0.5	94	86
R-78AA6.5-0.5SMD	8.0 – 32	6.5	3.3~11.0	0.5	95	88
R-78AA9.0-0.5SMD	11 – 32	9.0	4.5~12.6	0.5	96	92
R-78AA12-0.5SMD	15 – 32	12	4.5~12.6	0.5	97	94
R-78AA15-0.5SMD	18 – 32	15	fixed	0.5	97	95

Note 1: 1.5V Output can be unstable with Vin > 30VDC

\* add suffix -R for tape&reel packing e.g. R-78AA5.0-0.5-R. For more details see Application Notes.

## Standard Application Circuit



To protect the converter from high inrush currents, use soft start Vin and C1=10µF  
Output capacitor C2 recommended if load is very dynamic

**INNOLINE**  
DC/DC-Converter  
with 3 year Warranty

**RECOM**

**0.5 AMP**  
**SMD**  
**Single Output**



**EN-60950-1 Certified**

# R-78AA-0.5

## Derating-Graph (Ambient Temperature)

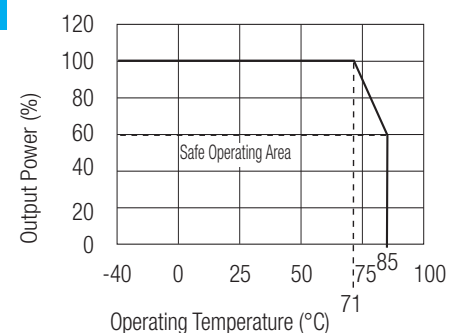

**Specifications** ( typical at 25°C, 10% minimum load, unless otherwise specified )

Characteristics	Conditions	Min.	Typ.	Max.
Input Voltage Range	See Table	4.75V	32V	34V abs. max.
Output Voltage Range	See Table	1.5V		15V
Output Current (see Note)	All Series	0mA*		500mA
Output Current Limit	All Series			2000mA
Short Circuit Input Current	Vin = 24V		60mA	100mA
Internal Power Dissipation				0.4W
Short Circuit Protection			Continuous, automatic recovery	
Output Voltage Accuracy	100% Load		±2%	±3%
Adjustable Voltage Range	See Table 1			±50%
Line Voltage Regulation (Vin = min. to max. at full load)	1.5V to 6.5V		0.2%	0.4%
	9V to 15V		0.1%	0.2%
Load Regulation (10 to 100% full load)	1.5V to 6.5V		0.7%	1.0%
	9V to 15V		0.25%	0.4%
Dynamic Load Stability with 100µF Output capacitor	100% <-> 50% load		±75V	±100mV
	100% <-> 10% load		±100mV	
Ripple & Noise (without Output Capacitor)	1.5V to 6.5V		20mVp-p	30mVp-p
	9V to 15.5V		30mVp-p	40mVp-p
Temperature Coefficient	-40°C ~ +85°C ambient			0.015%/°C
Max capacitance Load	with normal start-up time, no external components			220µF
	with <1 second start up time + diode protection circuit			6800µF
Switching Frequency		280kHz	330kHz	380kHz
Quiescent Current	Vin = min. to max. at 0% load		5mA	7mA
ON/OFF Remote Control Pin Drive Current	ON: Open or 1.6V<Vr<5V			
	OFF: GND or 0<Vr<1.6V		Ir=1.8µA typ	
Converter Input Current (valid for Vr < 1.6V)			20µA	30µA
Remote On/Off Threshold Voltage (Vr rising)		2.4V	2.6V	2.8V
Remote On/Off Voltage Hysteresis			250mV	
Operating Temperature Range (with derating)		-40°C		+85°C
Switch On/Off Time	(using Remote On/Off Control)			50ms
Operating Case Temperature				+100°C
Storage Temperature Range		-55°C		+125°C
Case Thermal Impedance				70°C / W
Thermal Shutdown	Internal IC junction			+160°C
Case Material				Non-Conductive Black Plastic
Potting Material				Epoxy (UL94V-0)
EMC	Conducted Emissions (with filter)	EN55022		Class B
	Radiated Emissions (with filter)	EN55022		Class B
	ESD	EN61000-4-2		Class A
	Radiated Immunity	EN61000-4-3		Class A
	Fast Transient	EN61000-4-4		Class A
	Conducted Immunity	EN61000-4-6		Class A
	Magnetic Field Immunity	EN61000-4-8		Class A
	Safety Certification	Report: PS-R7242C1		
Package Weight			2.7g	
Packing Quantity				33pcs per Tube
				250pcs per Reel
MTBF (+25°C) (+71°C)	} Detailed Information see Application Notes chapter "MTBF"	using MIL-HDBK 217F		21098~29253 x 10 <sup>3</sup> hours
				4214-7365 x 10 <sup>3</sup> hours

\*Note: Operation under no load will not damage these devices, however they may not meet all specifications. A minimum load of 6mA is recommended

Characteristics

## Efficiency

## Ripple

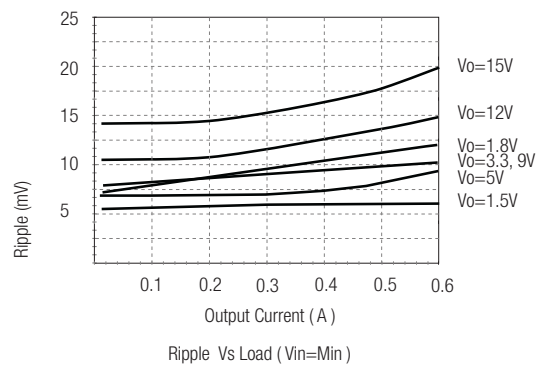
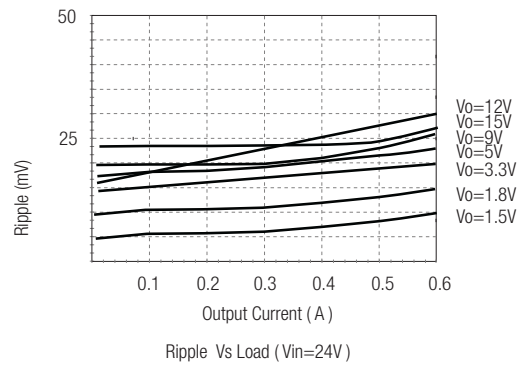
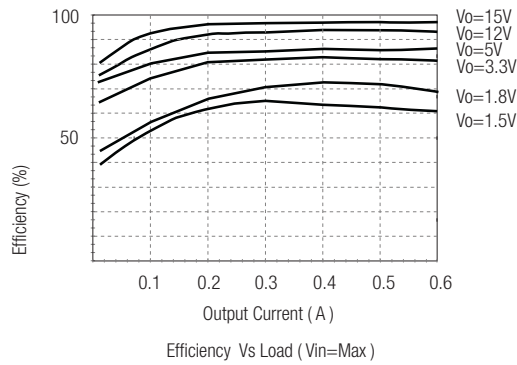
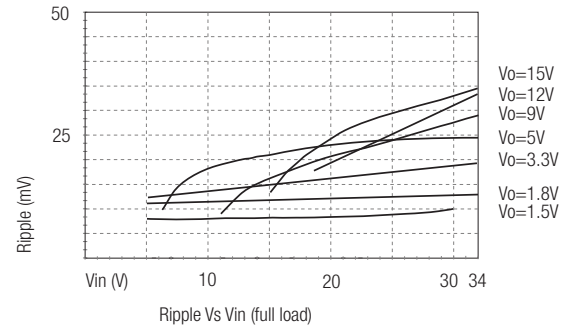

R-78AA-0.5

Application Examples

Flash Memory Program Voltage Switcher



"Program" = 0V, Pgm Pin = +5V  
 "Program" = high, Pgm Pin = +12,6V

DC/DC Converter ( 1:1 )



- High isolation voltage
- Improved loading / line regulation
- Wide Input Voltage Range
- Point-of-Load Architecture
- Remote On/Off Control

Optional Protection Circuit

Optional Protection 1:

Add a blocking diode to Vout if current can flow backwards into the output, as this can damage the converter when it is powered down.

The diode can either be fitted across the device if the source is low impedance or fitted in series with the output (recommended).

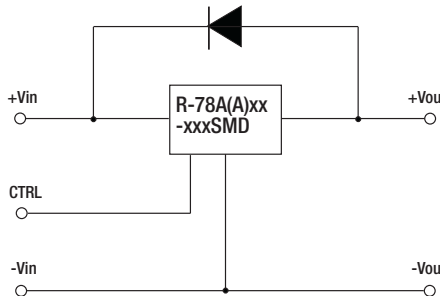

Optional Protection 2:

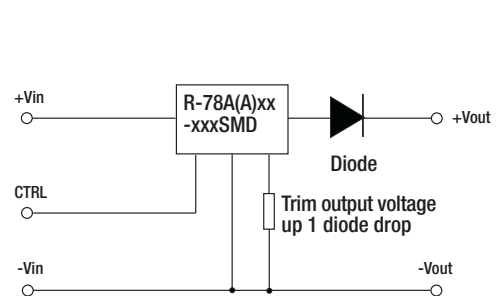

Application example:  
Driving a high capacitive load

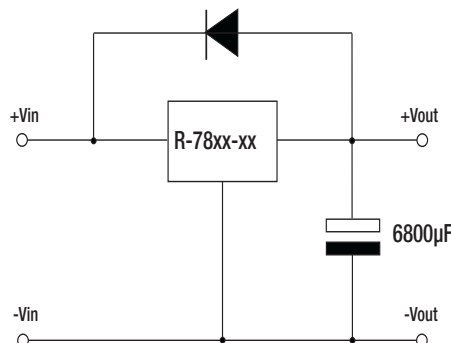

**Table 1: Adjustment Resistor Values**

0.5A <sub>dc</sub>	R-78AA1.8		R-78AA2.5		R-78AA3.3		R-78AA5.0		R-78AA6.5		R-78AA9.0		R-78AA12	
V <sub>out</sub> (nom.)	-0.5SMD		-0.5SMD		-0.5SMD		-0.5SMD		-0.5SMD		-0.5SMD		-0.5SMD	
	1.8V <sub>dc</sub>		2.5V <sub>dc</sub>		3.3V <sub>dc</sub>		5.0V <sub>dc</sub>		6.5V <sub>dc</sub>		9.0V <sub>dc</sub>		12.0V <sub>dc</sub>	
V <sub>out</sub> (adj.)	R1	R2	R1	R2	R1	R2	R1	R2	R1	R2	R1	R2	R1	R2
1.5 (V)	3K $\Omega$		200 $\Omega$											
1.8 (V)			12K $\Omega$											
2.5 (V)		11.8K $\Omega$												
3.0 (V)		4.64K $\Omega$		44.2K $\Omega$	88.4K $\Omega$		17K $\Omega$							
3.3 (V)							27K $\Omega$		6.7K $\Omega$					
3.6 (V)						60.4K $\Omega$	42K $\Omega$		14K $\Omega$					
3.9 (V)						28K $\Omega$	58K $\Omega$		23K $\Omega$					
4.5 (V)						11.3K $\Omega$	180K $\Omega$		49K $\Omega$		26K $\Omega$		17K $\Omega$	
4.9 (V)						7.15K $\Omega$	850K $\Omega$		77K $\Omega$		36K $\Omega$		24K $\Omega$	
5.0 (V)						6.34K $\Omega$			86K $\Omega$		39K $\Omega$		26K $\Omega$	
5.1 (V)						5.9K $\Omega$		231K $\Omega$	97K $\Omega$		42K $\Omega$		28K $\Omega$	
5.5 (V)						3.9K $\Omega$		56.2K $\Omega$	160K $\Omega$		56K $\Omega$		36K $\Omega$	
6.5 (V)								14K $\Omega$			112K $\Omega$		63K $\Omega$	
8.0 (V)								2.32K $\Omega$		24.6K $\Omega$	400K $\Omega$		125K $\Omega$	
9.0 (V)										10.7K $\Omega$			200K $\Omega$	
10 (V)										4.75K $\Omega$		54.9K $\Omega$	345K $\Omega$	
11 (V)										1.65K $\Omega$		16.5K $\Omega$	740K $\Omega$	
12 (V)												3.6K $\Omega$		
12.6 (V)												0 $\Omega$		180K $\Omega$

R-78AA-0.5

### Package Style and Pinning (mm)

#### SMD 10Pin Package

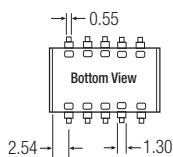
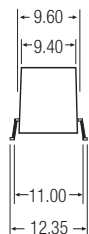

#### Recommended Footprint Details



#### Pin Connections

Pin #	Connection
1,2	+Vin
3,7,8,9	GND
4,5	+Vout
6	V adj
10	Remote On/Off

xx.x  $\pm 0.5\text{mm}$   
xx.xx  $\pm 0.25\text{mm}$

## Данный компонент на территории Российской Федерации

### Вы можете приобрести в компании MosChip.

Для оперативного оформления запроса Вам необходимо перейти по данной ссылке:

<http://moschip.ru/get-element>

Вы можете разместить у нас заказ для любого Вашего проекта, будь то серийное производство или разработка единичного прибора.

В нашем ассортименте представлены ведущие мировые производители активных и пассивных электронных компонентов.

Нашей специализацией является поставка электронной компонентной базы двойного назначения, продукции таких производителей как XILINX, Intel (ex.ALTERA), Vicor, Microchip, Texas Instruments, Analog Devices, Mini-Circuits, Amphenol, Glenair.

Сотрудничество с глобальными дистрибьюторами электронных компонентов, предоставляет возможность заказывать и получать с международных складов практически любой перечень компонентов в оптимальные для Вас сроки.

На всех этапах разработки и производства наши партнеры могут получить квалифицированную поддержку опытных инженеров.

Система менеджмента качества компании отвечает требованиям в соответствии с ГОСТ Р ИСО 9001, ГОСТ РВ 0015-002 и ЭС РД 009

### Офис по работе с юридическими лицами:

105318, г.Москва, ул.Щербаковская д.3, офис 1107, 1118, ДЦ «Щербаковский»

Телефон: +7 495 668-12-70 (многоканальный)

Факс: +7 495 668-12-70 (доб.304)

E-mail: [info@moschip.ru](mailto:info@moschip.ru)

Skype отдела продаж:

moschip.ru

moschip.ru\_4

moschip.ru\_6

moschip.ru\_9